

DewStop[®] Moisture

with QUE™ Ultra Moisture-Sensing,
Adaptive Technology

HS-C00

Smart Bathroom Fan Control

ENGLISH
LANGUAGE
MANUAL

Go To Research
Technologies, Inc.
Seattle, WA, USA

(A.) ABOUT DewStop[®]

DewStop is intended for condensation problem areas of a home, such as near the shower or bath. If condensation is a problem or is suspected to be a problem, simply replace your existing fan switch with DewStop. For DewStop to sense condensation, the room will need to show visible signs of wetness attaching to surfaces, such as steam on walls / mirrors / fixtures. Visible steam in the air is not the problem, the problem occurs when moisture in the air becomes too heavy and the air cannot support the moisture. The moisture then moves to surfaces (this is the dew point), triggering the DewStop sensors. The remarkable DewStop product is constantly checking the air for condensation. At the right time, DewStop will turn ON your fan and run the fan to clear the room. NOTE: A good quality fan properly sized for the room is essential to the successful removal of moisture from any room. DewStop only detects condensation, it cannot stop it. DewStop relies on a closed room and a quality fan to properly detect condensation and dry a room.

(B.) INSTALLATION INSTRUCTIONS

CAUTION

1. Use only a 120V AC 60Hz power supply connection.
2. For indoor use only.
3. Do not exceed DewStop's maximum electrical load ratings, as indicated on the product label.
4. Must be installed and used in accordance with your local electrical codes.

5. If a bare copper or green ground connection is not available in the wall box, contact a licensed electrician for installation.
6. For use with permanently installed 120V AC powered fans only.
7. Use only #14 or #12 copper wire connections.

WARNING

Turn OFF circuit breaker or remove fuse(s) and test that power is OFF before wiring. Wiring DewStop live can cause serious risk of electrical shock and/or damage the control, voiding the warranty. FOR SAFETY, THIS PRODUCT MUST BE INSTALLED IN A GROUNDED WALL ENCLOSURE. If you are unfamiliar with methods of installing electrical wiring, secure the services of a qualified licensed electrician. USE ONLY COPPER WIRE, DO NOT use aluminum wire with this device.

IMPORTANT

Read each step carefully and perform in sequence. DewStop will not work or will become damaged if wires are connected incorrectly. To prevent damage, connect DewStop exactly as shown in the installation diagrams, otherwise warranty will be voided. Prior to wiring, straighten or clip ends of wire such that ends of each wire are straight (if using DewStop to replace an existing switch). Strip wire insulation at the end of each wire to expose 5/8 inch (16 mm) of copper. Where instructed to make a connection, twist ends of stripped wires together and twist a proper connector clockwise until secure.

1

2

(C.) INSTALLATION STEPS

1. WARNING
To avoid fire or risk of electrical shock, turn OFF power at circuit breaker or disconnect fuse. Test the power is OFF before you begin wiring.
2. BEFORE YOU MOUNT THE CONTROL
(new installation) Install DewStop in a 3½ inch deep single-gang or multi-gang electrical wall enclosure. OR (replacement of existing switch) remove existing wall plate and switch device being replaced.
3. ATTACH POWER WIRE AND FAN WIRE
Attach 120V AC 60Hz 3-wire power (Hot / Neutral / Ground) inside the wall enclosure with a minimum of 6 inch leads. Attach three fan wire leads inside the wall enclosure also with minimum 6 inch leads. If an existing power connection is used in an existing wall enclosure you must confirm proper AC 120V Hot / Neutral / Ground are available.
4. CONNECT WIRING
General instructions for all configurations:
Make sure the wall enclosure, fan, and DewStop are properly grounded (See FIGURE #1).

(D.) MOUNTING IN WALL ENCLOSURE

1. Attach wires (as shown in FIGURE #1).

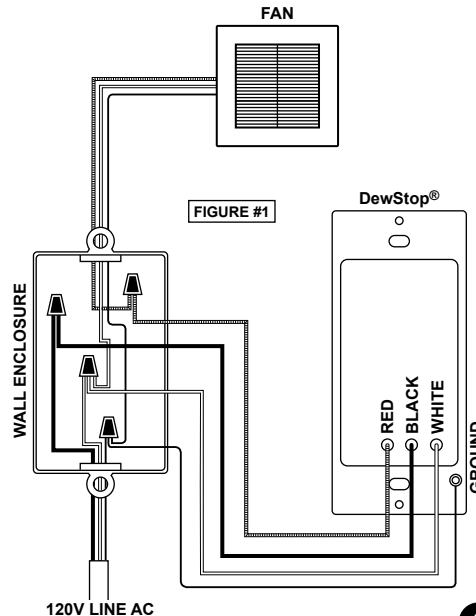

3

4

2. Tuck wires into wall enclosure and fasten DewStop to the wall enclosure with the two screws provided (See FIGURE #2).

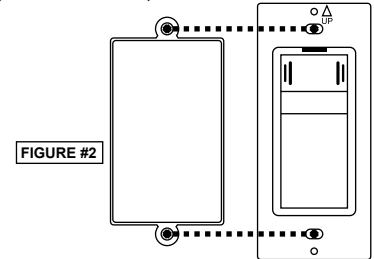

FIGURE #2

3. Attach the wall plate (See FIGURE #3).

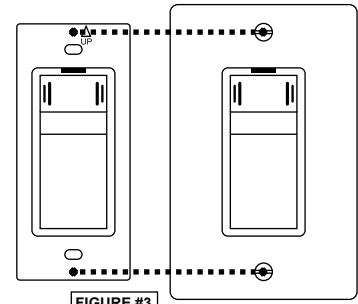

FIGURE #3

5

(E.) CONTROL FUNCTIONS

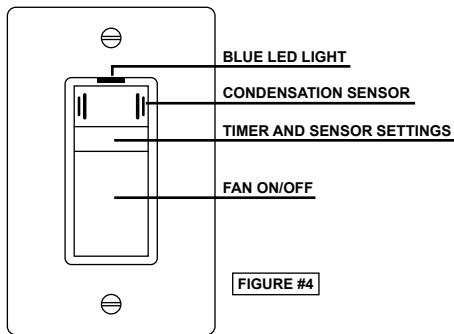

FIGURE #4

Blue LED Light: Lets you know when your fan is on (especially useful for fans with low sound levels).

Condensation Sensor: Senses moisture in the room and turns your fan ON and OFF automatically.

Timer and Sensor Settings: Countdown timer (left) and moisture sensitivity (right) settings (hidden behind a removable cover – see pages 7-8 for details)

The diagram shows two dials. The left dial is labeled 'TIMER' and has markings for 15, 30, 45, and 60 minutes. The right dial is labeled 'SENSITIVITY' and has a minus sign (-) on the left and a plus sign (+) on the right, with a central arrow pointing up.

Fan ON/OFF: Turns countdown timer ON and OFF (can be used to temporarily override condensation sensor).

6

(F.) CHANGING THE SETTINGS

By default, DewStop comes with the moisture sensitivity set to average levels, and the countdown timer set to 30 minutes. To change the settings, remove the "Timer and Sensor Settings" cover by taking off the face plate and then inserting the end of the included tool (or a **non-metal** tool of your own) into the two holes on either side of the control (see FIGURE #5). Use the included tool to turn the settings dials. The countdown timer can be set between 5–60 minutes. Moisture sensitivity can be set at low, average, or high sensitivity. Once you change a setting, the changes will take effect after the next ON/OFF cycle, so it's recommended that you turn your fan ON then OFF after you make a change to the settings.

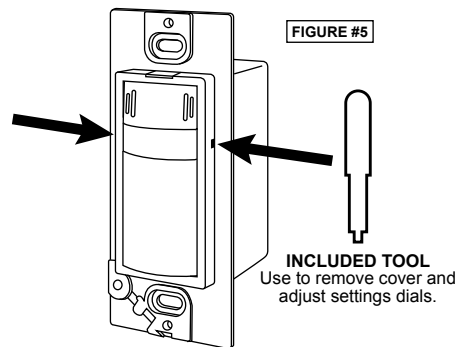

FIGURE #5

INCLUDED TOOL
Use to remove cover and adjust settings dials.

7

(G.) MANUAL ON/OFF

Press the "Fan ON/OFF" button once to manually turn fan ON, and again to turn fan OFF.

(H.) COUNTDOWN TIMER

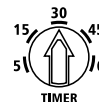

When the fan is turned ON manually, the countdown timer will run your fan for your selected period of time, then turn your fan OFF.

(I.) MOISTURE SENSITIVITY

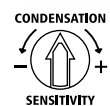

The minus sign is low moisture sensitivity and the plus sign is high sensitivity; the dial can be set anywhere in between. In a very moist environment, lower sensitivity may be needed to avoid excessive fan run-time. In a very dry environment, higher sensitivity may be needed for the sensor to detect moisture. When DewStop senses condensation, the blue LED will pulse slowly.

Setting Sensitivity:

The factory setting of the moisture sensitivity dial is set to the noon position. If you feel the factory setting is too slow in turning on your fan, turn the dial to the right an hour at a time. Or, if you feel the factory setting turns your fan on too quickly, turn the dial to the left an hour at a time until the desired sensitivity level is reached.

8

(J.) TESTING DewStop®

1. After you have completely installed DewStop, selected your timer and sensor settings, and attached the wall plate on the control, you can turn on the breaker to apply power.

WARNING: If the breaker trips or the fuse blows, STOP and call a qualified electrician to investigate the problem. Turn the breaker OFF until the problem has been corrected.

2. Press the Fan ON/OFF button to see the fan turn ON, press the button again to see the fan turn OFF.

3. With the fan OFF, you can test the sensor by blowing into the sensor as if you were blowing on a mirror to steam it. Use three puffs of breath and the fan will come ON automatically. The blue LED will pulse slowly; this shows you DewStop is sensing condensation.

4. Sensor Shut-Off: To turn off the sensor and make DewStop just a manually activated adjustable timer, hold down the fan ON/OFF button for 15 seconds. To turn the sensor back on, do so again.

ELECTRICAL SHOCK WARNING:

DewStop is an automatic ON device. At no time should a person work on the fan/light or any DewStop connected appliance without the electrical circuit breaker or fuse switched OFF. DewStop could turn ON the attached device by the unintended presence of condensation while the work is being performed. Always disconnect the AC power before any work is done to any part of the circuit DewStop is connected to. If you do not understand this warning, seek the services of a qualified licensed electrician.

9

(K.) AIR DRAFTS IN WALL ENCLOSURE

Older homes may experience air flowing (drafts) from the inside wall cavity into or out of the wall enclosure depending on the draft situation. If your DewStop is experiencing problems sensing condensation, sealing any enclosure openings is needed. The wall enclosure is easy to seal with standard painter's caulking and a caulking gun. To begin you must DISCONNECT all electrical power to the control before sealing the openings. Unscrew all box switches and pull them forward to allow access to the back of the enclosure. Apply caulking into all openings in the enclosure, even the very small ones. Seal every opening and around electrical wires at their entering point. Also seal the perimeter around the enclosure between the wall board and the enclosure. This will stop heat loss and allow DewStop to sense the room and not the drafts in the walls. See FIGURE #6:

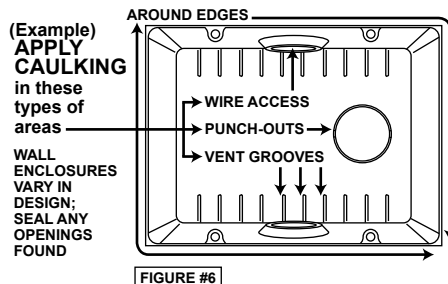

FIGURE #6

10

(L.) TWO-YEAR LIMITED WARRANTY

Go To Research Technologies, Inc. (GTR) warrants to the original consumer purchaser of its products that such products will be free from defects in materials & workmanship for a period of two years from the date of original purchase. There are no other warranties, express or implied, including but not limited to, implied warranties of merchantability or fitness for a particular purpose. During this two-year period, GTR will, at its option, repair or replace, without charge, any product or part which is found to be defective under normal use & service. This warranty does not extend to fluorescent lamp starters & tubes. This warranty does not cover (a) normal maintenance & service or (b) any maintenance or repair, faulty installation or installation contrary to recommended installation instructions. The duration of any implied warranty is limited to the two-year period as specified for the express warranty. Some areas do not allow limitation on how long an implied warranty lasts, so the above limitation may not apply to you. GTR's obligation to repair or replace, at GTR's option, shall be the purchaser's sole & exclusive remedy under this warranty. GTR shall not be liable for incidental, consequential, or special damages arising out of or in connection with product use or performance. Some areas do not allow the exclusion or limitation of incidental or consequential damages, so the above limitation may not apply to you. This warranty gives you specific legal rights, & you may also have other rights, which vary from area to area. This warranty supersedes all prior warranties. To qualify for warranty service, you must (a) notify GTR at the address stated below or via our website at www.DewStop.com, (b) give the model number & part number identification, & (c) describe the nature or any defect in the product or part. At the time of requesting warranty service, you must present evidence of the original purchase date.

Go To Research Technologies, Inc.
www.DewStop.com

11