

PLEASE FOLLOW BELOW INSTRUCTION TO PREVENT PRODUCT TIP OVER.

HARDWARE PART LIST				QTY
x2				1 SET
BRACKET	LONG SCREW	SHORT SCREW	CABLE TIE	

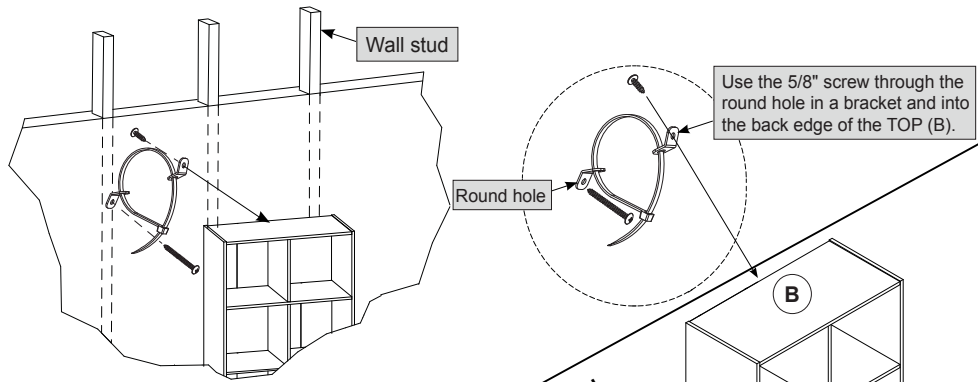

Recommended Maximum Weight

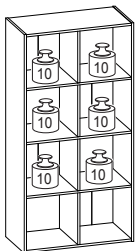

*Unit in Pound(lbs)

WARNING:

>This unit has been designed to support the maximum loads shown. Exceeding these load limits could cause sagging, instability, product collapse, and/or serious injury.

>DO NOT allow children to climb on unit.

>Put heavier items on lower shelves.



00:30

Approx. 30 minutes

Assembly Instruction

Furinno 8 CUBE CABINET

MODEL : **18054**

Recomm. 2 Persons

Tools Required

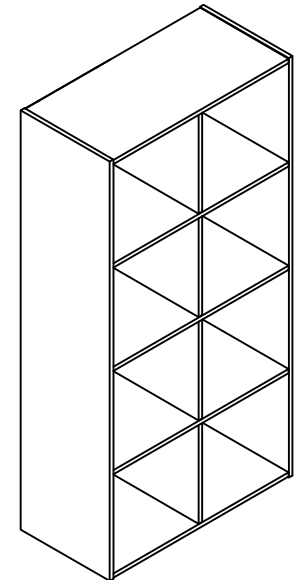





Customer Support

NEED HELP? For replacement requests or product inquiries, please contact our Customer Service Team by emailing us at support@furinno.com. Thank you for selecting Furinno!

www.furinno.com



HARDWARE & PARTS LIST

NO	HARDWARE LIST	QTY
1	SCREW 	22pcs
2	BACK PLUG 	32pcs
3	LONG DOWEL 	6pcs
4	SHORT DOWEL 	4pcs
5	SCREW COVER CARD 	22pcs

NO	PARTS LIST	QTY
A	SIDE PANEL	2pcs
B	TOP / BOTTOM PANEL	2pcs
C	SHELF PANEL	3pcs
D	CENTER SIDE PANEL	4pcs
E	BACK PANEL	4pcs

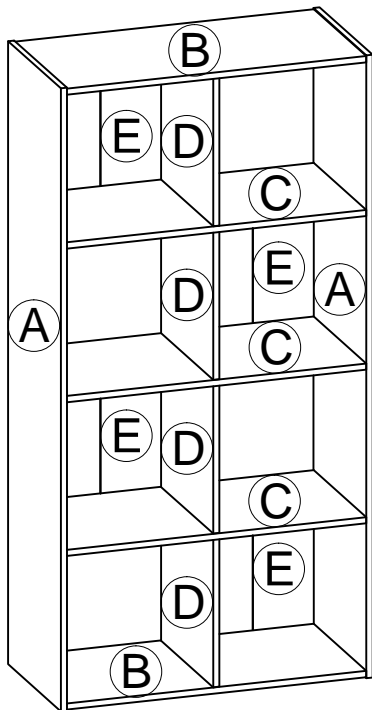

USEFUL HINTS BEFORE YOU START:

1. Read each step carefully before starting.
2. It is important that each step is performed in correct order to avoid difficulties.
3. Identify, sort and count the parts before assembly.
4. Assemble your furniture on packaging cardboard to prevent scratch or damage.
5. Clean the product with mild cleanser using soft damped cloth. Do not use harsh or abrasive cleanser.
6. Using incompatible hardware might cause damage to product.

ASSEMBLY INSTRUCTIONS

BEFORE YOU BEGIN, PLEASE READ ASSEMBLY INSTRUCTION CAREFULLY, FOLLOW THEM STEP BY STEP.

