

USE AND CARE GUIDE

10'X 10' Square Pergola

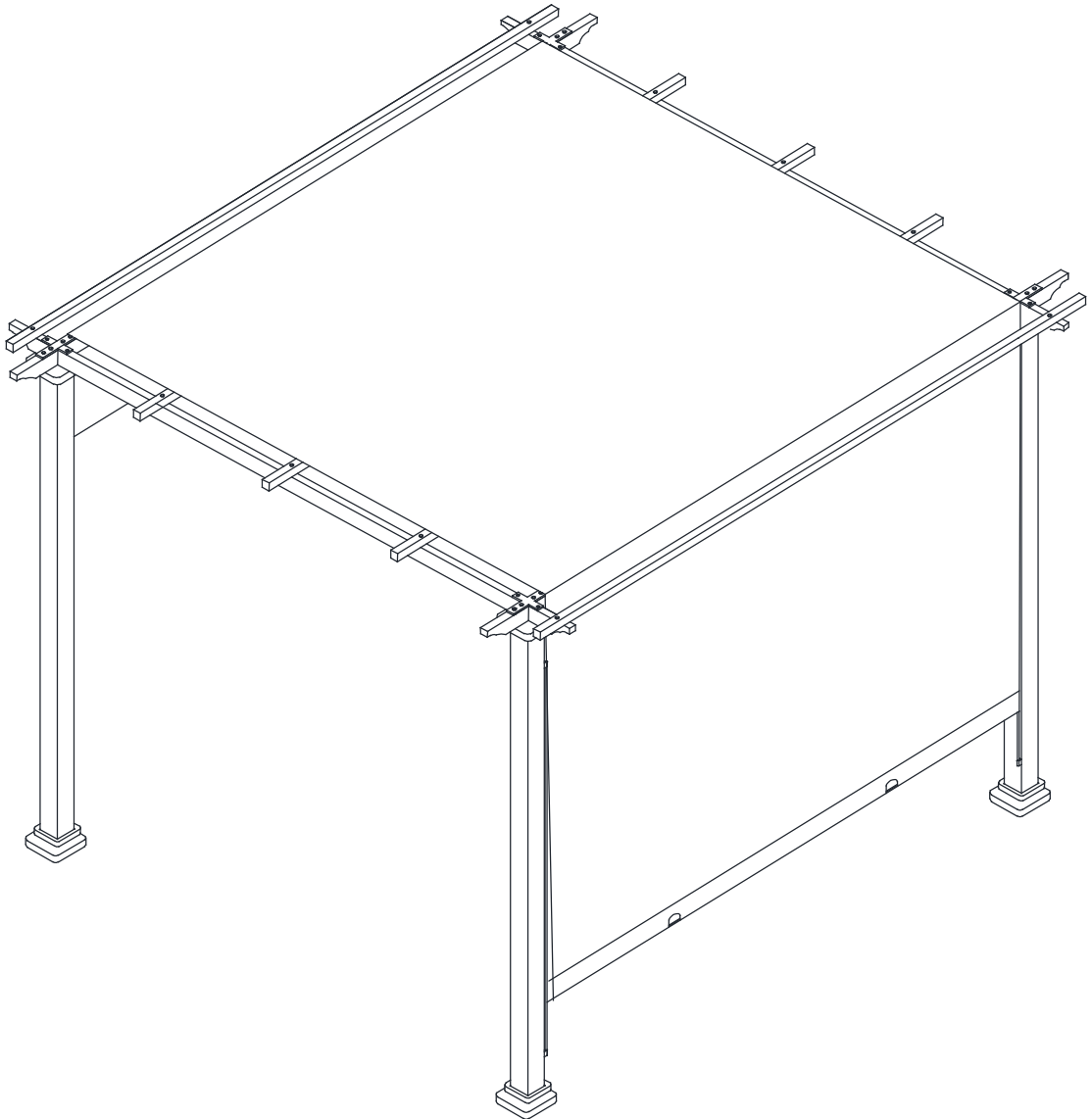

Pre-installation

PLANNING INSTALLATION

To prevent damage, place all parts on a soft surface during assembly.

Tools required for assembly (not included): Allen wrench (included), hammer, screwdriver, stepladder, level and other safety items such as gloves, safety goggles and hardhat.



NOTE: Tools and protective articles below are not provided.

TOOLS REQUIRED



Hammer



Screwdriver



Safety goggles



Gloves



Hardhat



Stepladder









Level

HARDWARE INCLUDED



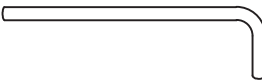
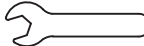









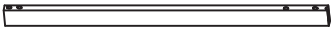
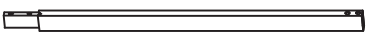

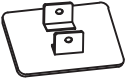
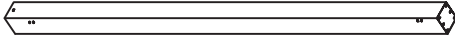
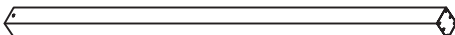

NOTE: Hardware not shown to actual size.

AA	Bolt\Flat Washer M6*15		67
BB	Bolt\Flat Washer M6*40		10
CC	Bolt\Flat Washer M6*80		24
DD	Bolt\Flat Washer M6*15		8
EE	Bolt\Flat Washer M6*75		8
FF	Stake		16
GG	Wrench		1
HH	Allen Wrench		1



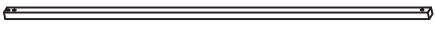



Pre-installation (continued)

PACKAGE CONTENTS

A1	Left Crossbar		2
A2	Right Crossbar		2
B1	Left Crossbar		2
B2	Right Crossbar		2
C	Crossbar decoration		4
D1	Roof Tube		5
D2	Roof Tube		5
E	Roof Cap		4
F	Base Cover		4
G	Base		4
H1	Post		2
H2	Post		2
I	Connector		4
J1	Outer Connector		4
J2	Outer Connector		5
K	Fabric tube		2
K1	Fabric tube 1		2

Pre-installation (continued)

PAC KAG E CONTENTS

L1	Rail tube connector 1		4
L2	Rail tube connector 2		2
L3	Rail tube connector 3		2
M	Fabric tube connector		4
N	Rail tube		4
O	Canopy		1