

HOME DECORATORS COLLECTION

James Counter Stool ASSEMBLY INSTRUCTION

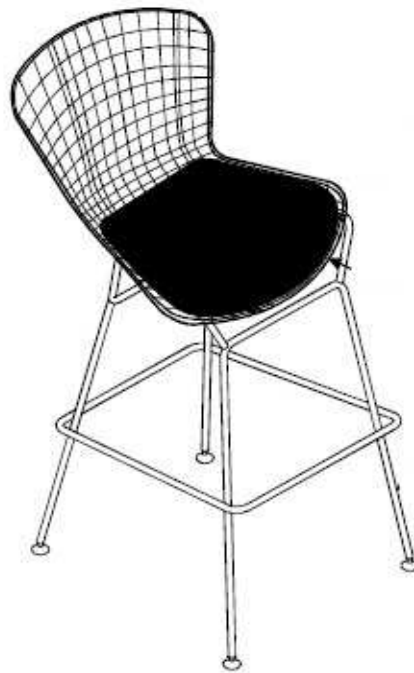









Model No: IC-169C
HDC#: 0277100250

Thank you for purchasing this quality products, be sure to check all packing material carefully for small parts,which may have came loose inside the carton during shipment, Count all parts and material hardware and compare with parts list to eensure all parts are present. If any parts are missing or damaged, phone,fax,or mail to our customer service department, For efficient and speedy service,please indicate the model number and code letter of part(s) needed.

IMPORTANT NOTE: Follow instructions listed below in proper sequence as numbered to assure fast, easy and correct assembly.

PARTS LIST

<p>A</p>  <p>seat Frame-1pc</p>	<p>B</p>  <p>Leg-1pc</p>	<p>C</p>  <p>cushion-1pc</p>
<p>D</p>  <p>Allen Wrench-1pc</p>	<p>E</p>  <p>M6*25 Screw-4pcs</p>	<p>F</p>  <p>Connector-4pcs</p>
<p>G</p>  <p>Blind Nut-4pcs</p>	<p>H</p>  <p>wrench-1pc</p>	<p>I</p>  <p>adjustable feet-4pcs</p>

1

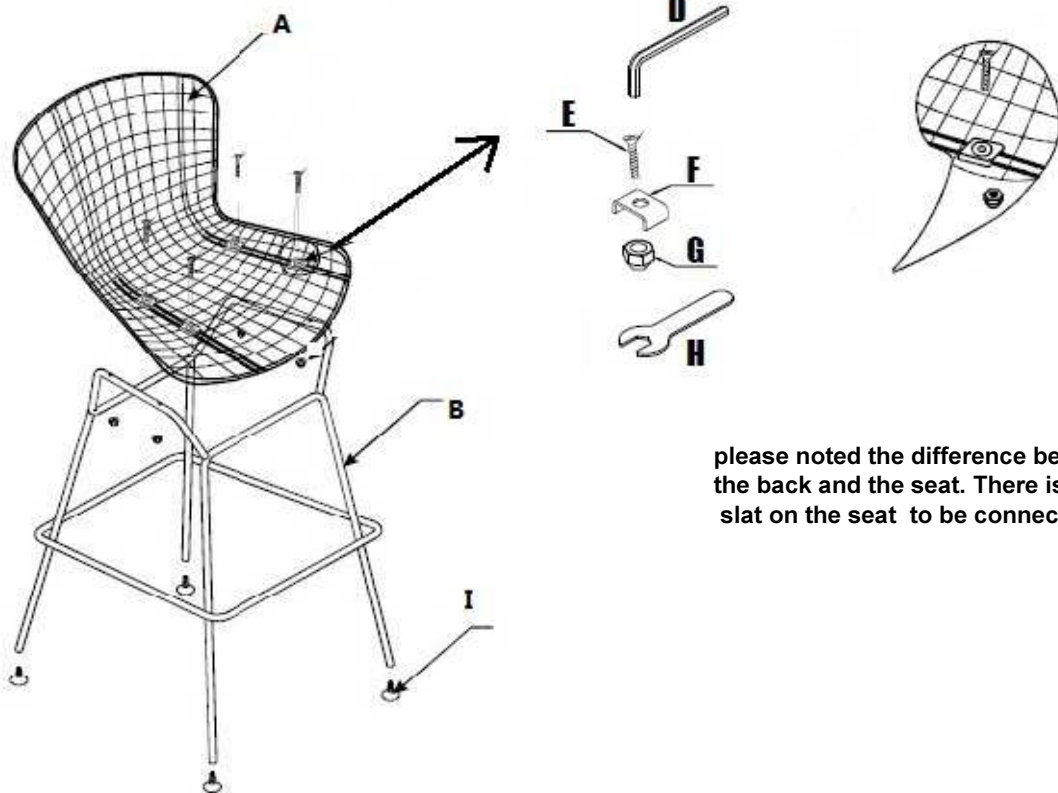

please noted the difference between the back and the seat. There is two short slat on the seat to be connected to the leg

Note: keep the holes of the seat pannel and leg in line, use the M6 screw to reinforce only.

2

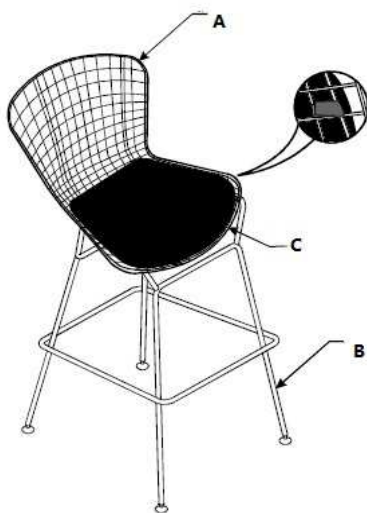

fix the cushion on the seat