

Installation Instructions - Shower Caddy with IncrediGrip™ Positioners

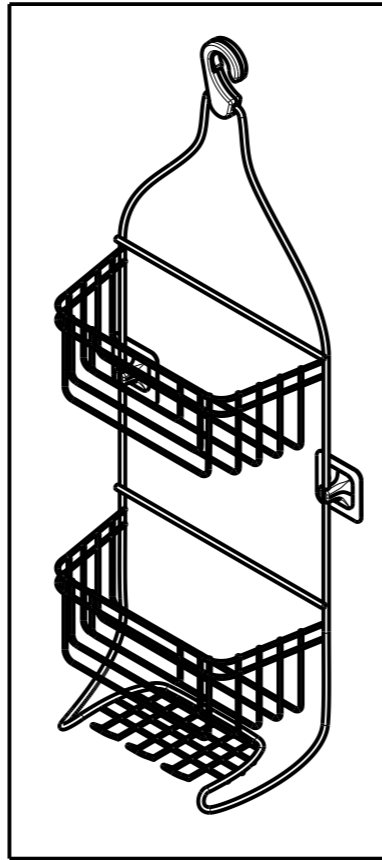

FranklinBrass®
INCREDI GRIP™

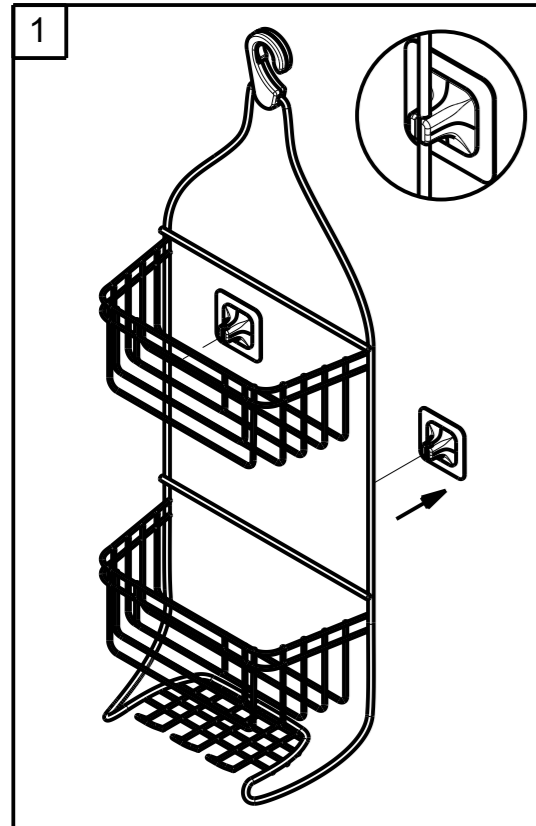

1
Read and follow these instructions carefully. Failure to follow these instructions could result in injury or property damage.

Attach the IncrediGrip™ pads to the attachment points on the shower caddy using the Mounting Post. Do not remove the thin protective film on the back of the IncrediGrip™ pads at this time.

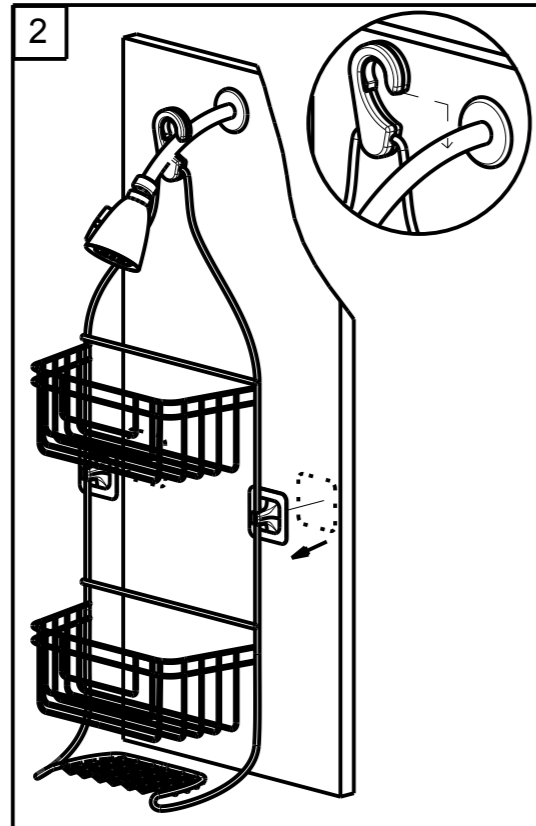

2
Hang shower caddy on a shower head and position it in desired location and note the location of the IncrediGrip™ pads. To prevent the basket from falling, which could cause injuries or property damage, do not position the IncrediGrip™ pads across any tile grout lines or other surface feature that could interfere with application.

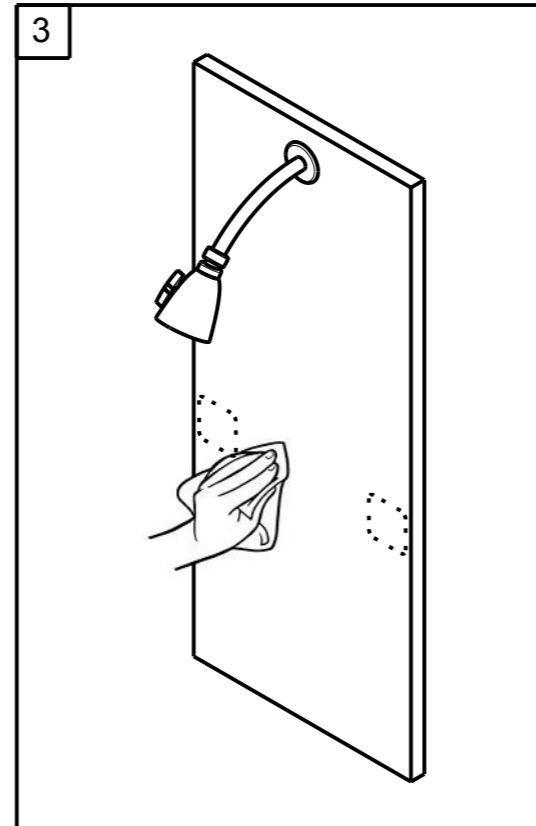

3
Clean surface areas where IncrediGrip™ pads will be installed with the provided Isopropyl Rubbing Alcohol pad or Windex® Glass Cleaner and a clean, lint free cloth. Do not use bathroom or other common household cleaners as they may leave a film that prevents pad adhesion or may cause pads to adhere only temporarily to the surface, which could cause the basket to fall and cause injury or property damage.

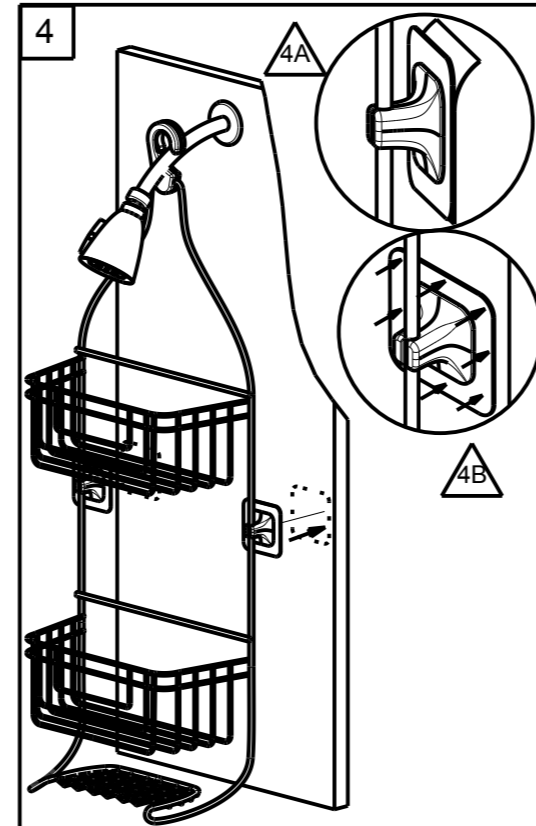

4
4A) Remove the protective film from the IncrediGrip™ pads and locate assembly onto mounting surface in desired position. 4B) Using your fingers, partially secure the IncrediGrip™ pads at each location by pressing the pads firmly into the wall.

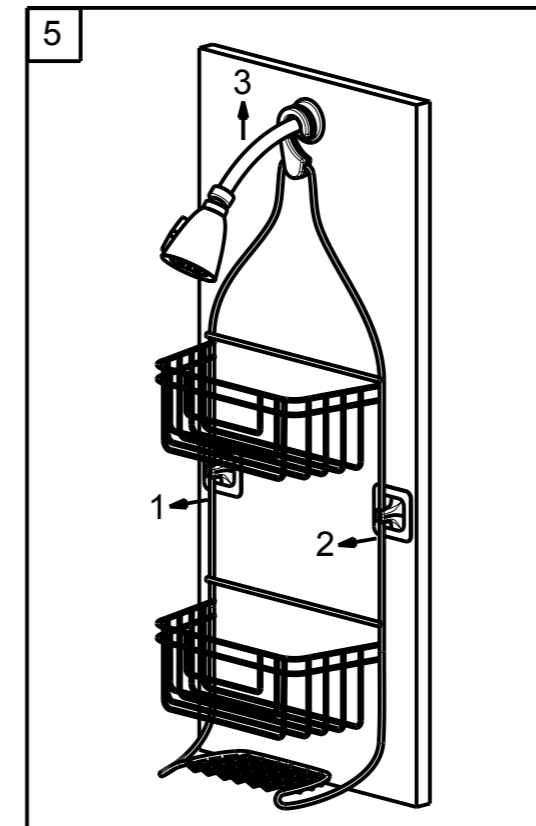

5
Remove the shower caddy by pulling the left side and then right side of the caddy out of Mounting Posts.

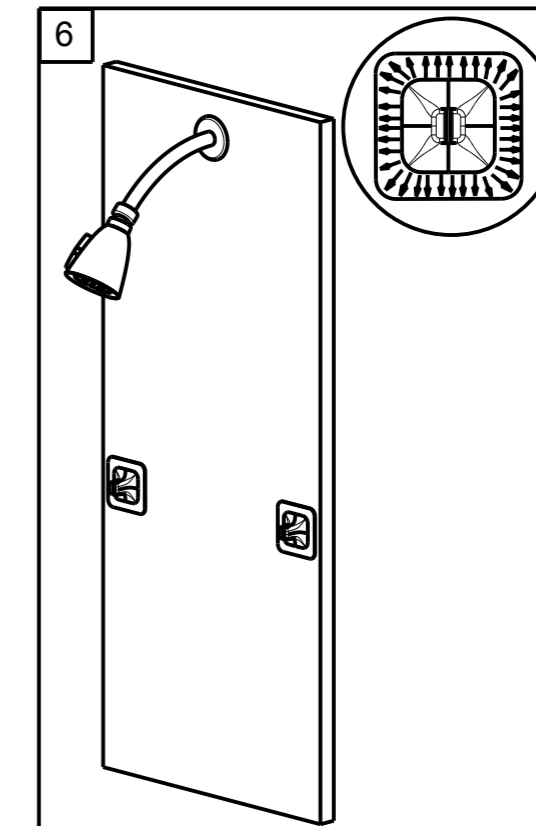

6
With shower caddy removed, firmly press on IncrediGrip™ pads and smooth the air bubbles out. Work from mounting post towards the outer edges of the pads. Optimal performance is achieved with removal of all air pockets from under clear pad areas. The failure to remove all air pockets may cause the pads to slip and the basket to fall, causing injury or property damage.

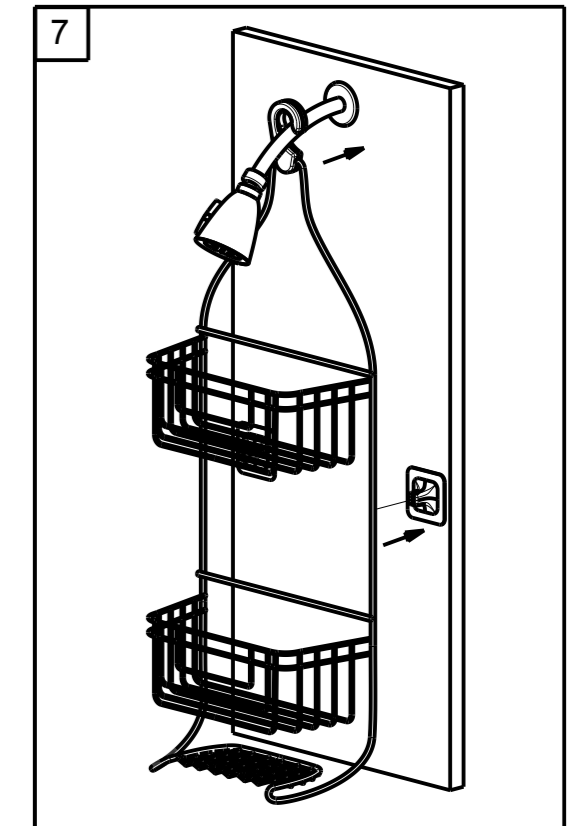

7
Once the IncrediGrip pads have been secured to the mounting surface, rehang the shower caddy onto the Mounting Post. For optimal performance, wait 30 minutes before loading basket.

IncrediGrip - Installation Instructions

Additional Notes:

- * Dusty, dirty IncrediGrip™ pads may be restored by hand rinsing under warm tap water.
- * Do NOT use bleach-based products containing Chloride or Sodium Hypochlorite such as Tilex® brand bathroom cleaners or 409® all-purpose or glass cleaners Mold & Mildew Remover.
- * DO NOT clean the IncrediGrip™ pad with any type of soap or cleaning products.

Removal & Repositioning:

1. Carefully remove all bottles and other items from wire caddy, basket or other storage component. Separate wire product from mounting clip by carefully removing wire from the mounting clip locations.
2. Carefully lift one edge of the pad material away from the mounting surface.
3. Slowly continue to peel away edge until entire pad has released from surface. Take care not to bend or crease any part of the adhesive pad.
4. Inspect pad for dirt, debris or other contaminants. If present, run IncrediGrip™ side of pad under warm water for 30-seconds and let dry thoroughly prior to reapplication.
5. Follow Steps 2 through 7 of the Installation Instructions to reinstall your product.

Troubleshooting:

If one or more of your IncrediGrip™ Pads slides down the glass, tile or shower surround surface, follow the steps outlined under Removal & Repositioning section.

Take extra care to clean the mounting surface using 70% Isopropyl Alcohol or Windex® Original Glass Cleaner and be sure to let the IncrediGrip™ pads dry thoroughly after they are rinsed.

Optimal performance is achieved with removal of all the pockets from under the IncrediGrip™ pad area and from behind the plastic hook.

If your IncrediGrip™ pads become creased or damaged contact Liberty Hardware Customer Care at (800) 542-3789 for replacements.

Wire product care instructions: Care should be given to the cleaning of this product. Although its finish is extremely durable, it can be damaged by harsh abrasives or polish. To clean, simply wipe gently with a damp cloth and blot dry with a soft towel.

Warranty Information Liberty Hardware® Manufacturing Corporation LIMITED LIFETIME WARRANTY

Subject to the terms of this warranty, Liberty Hardware® Manufacturing Corporation ("Liberty Hardware") warrants to the original consumer purchaser ("You") that the product will be free from defects in material and workmanship. If the product does not comply with this warranty, Liberty Hardware will repair or replace the product or, at Liberty Hardware's option, refund the purchase price. Repair, replacement, or refund of the original purchase price is your sole remedy under this or any other warranty on the product, whether expressed or implied.

Limited Warranty Period. The warranty period is for the lifetime of the product and begins on the date of the initial installation of the product for residential purposes.

Limitations on the Warranty. The warranty does not cover: (a) normal wear and tear; (b) damage through abuse, neglect, misuse, or as a result of any accident or act of God; (c) improper installation or maintenance; (d) commercial, industrial, institutional or other nonresidential use; or (e) products altered without Liberty Hardware's prior written consent. This warranty is not transferable. **Obligations of Purchaser.** If this product does not meet its warranty, return the product (postage prepaid) to the distributor or retailer from which it was purchased with proof of purchase and a written claim briefly describing the defect. You may be required to provide other information or evidence of the defect. Any returned product that is replaced or refunded becomes the property of Liberty Hardware.

Limitations on Implied Warranties. IMPLIED WARRANTIES, INCLUDING ANY WARRANTY OF MERCHANTABILITY OR FITNESS FOR A PARTICULAR PURPOSE, ARE LIMITED TO THE SAME DURATION AS THIS EXPRESS WARRANTY; OTHERWISE, LIBERTY HARDWARE DISCLAIMS ALL WARRANTIES, EXPRESS OR IMPLIED. Some states do not allow limitations on how long an implied warranty lasts, so the above limitation may not apply to You.

Disclaimer. NO OTHER EXPRESS WARRANTY HAS BEEN MADE OR WILL BE MADE ON BEHALF OF LIBERTY HARDWARE WITH RESPECT TO THE PRODUCT. LIBERTY HARDWARE SHALL NOT BE RESPONSIBLE FOR SPECIAL, INCIDENTAL OR CONSEQUENTIAL DAMAGES WHETHER ARISING OUT OF BREACH OF WARRANTY, BREACH OF CONTRACT, OR OTHERWISE. Some states do not allow the exclusion of incidental or consequential damages of an implied warranty so the above exclusion and limitation may not apply to You.

State Law. This warranty gives you specific legal rights, and You also may have other rights, which vary from state to state.

140 Business Park Drive • Winston-Salem, NC 27107
www.libertyhardware.com