



STYLE BOARD ON BOARD (Privacy)
SHADOWBOX (Semi-Private)
TRADITIONAL (Semi-Private)

INSTALLATION MANUAL

FACE MOUNT FOR DOG-EAR & SQUARE TOP PICKETS



Questions, problems, missing parts? Before returning to the store,
call Fiberon Customer Service
8 a.m. - 7 p.m., EST, Monday - Friday, 9 a.m. - 6 p.m., EST, Saturday

1-800-215-2740

FIBERONFENCING.COM

THANK YOU

We appreciate the trust and confidence you have placed in Fiberon through the purchase of this fencing. We strive to continually create quality products designed to enhance your home. Visit us online to see our full line of products available for your home improvement needs. Thank you for choosing Fiberon!

Pre-Installation

TOOLS REQUIRED

- Air compressor
- Tape Measure
- Wheel Barrow
- Post Hole Digger
- Saw
- Staple Gun
- Hammer
- Clamp
- Level
- Power Drill
- Rail & Bracket Locator Template (provided)

SUPPLIES

- Quick Set Concrete
- Gravel
- Twine or String
- Stakes
- Spray Paint
- 4 in. Lag Screw (for Face Mount Install)
- Galvanized Staples Leg: 1 1/4 / 1 1/2 in.
- Work Gloves
- Pencil

PRIOR TO INSTALLING THE FENCING



IMPORTANT: Please read and follow the instructions in this section before you begin installation of your fencing products.



NOTE: Prior to digging, confirm location of underground utilities with local authorities. Apply for permits if required by local authorities and codes. Local zoning laws, neighborhood associations and/or historic districts may regulate size, type placement and ability of fencing. Ensure compliance prior to installation.



NOTE: Due to variation in picket width, minor adjustments to gapping may be required. Care should be taken to ensure that spacing does not result in too large of gap at the end posts.

PLANNING:

- Determine total area to be fenced.
- Site-Built installation: Ensure the right amount of pickets and rails per section.
- Make adjustments for odd widths at the back corners or build partial sections equally. Example: If you have 8 feet left in a run, consider building two 4 ft. sections rather than a 6 ft. and a 2 ft..
- Determine the number of posts including gate post and gate location (if applicable).
- Installations are facilitated with the use of an air compressor or air driven staple gun.
- Recommendation fasteners include 1-1/4 - 1-1/2 in. long x 1/4 - 7/16 in. crown galvanized and oiled or stainless steel staples, 16 - 18 gauge. Name brand staples are more reliable. Air compressor set to 90-100 PSI.

All Purpose Post Installation

1 Dig hole:

- Dig hole 12 in. wide x 32 in. deep.

2 Add Gravel

- Add 6 in. gravel (depth now = 26 in.)

3 Set Post

- Add 160 lbs of concrete.

4 Next Post

- Set post at a maximum of 68 in. post-center to post-center.

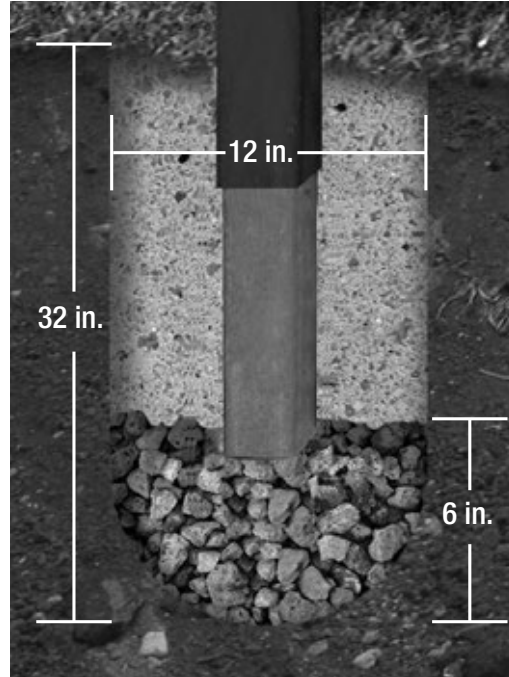

Cross Rail Installation



IMPORTANT: Through temperature changes of seasonal weather, Wood Composite Fencing will experience thermal expansion in the pickets and cross rails. To anticipate this expansion movement, our instructions include installation steps which need to be followed to prevent pressure from building in the fence during the hot summer months. Following these preventive steps will ensure a long lasting fence through the years. Avoid installing below 40 degrees.

USE RAIL & BRACKET LOCATOR

Pre-drill rail ends first, centering hole 1 in. from rail ends with 1/2 in. drill bit. Slightly angling the hole toward post center. Place Rail & Bracket Locator template square against the post. Slide rail into location of the pre-drilled holes, touch tighten only. Use 4 1/2 in. HeadLOK™ Fasten-Masters®, Heavy Duty Flathead Screws. Apply screws to bottom of the pre-drilled rail holes, leave screws loose, touch tighten. No nails or deck screws. Space rail ends 1/4 in. apart. This is necessary for the thermal expansion of the rails and pickets, which you can read below.



NOTE: Avoid applying screws to top 5 Inches of post tops.

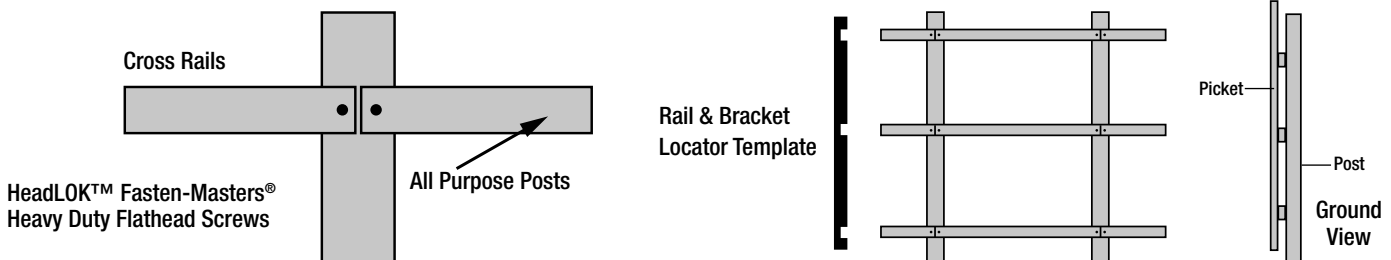

Picket Installation



NOTE: Face Mounting the backer rails makes the installation of each picket style much easier. There is no fitting a fixed number of pickets between the posts, just remember to cover each of the rail seams with some portion of a picket during installation.

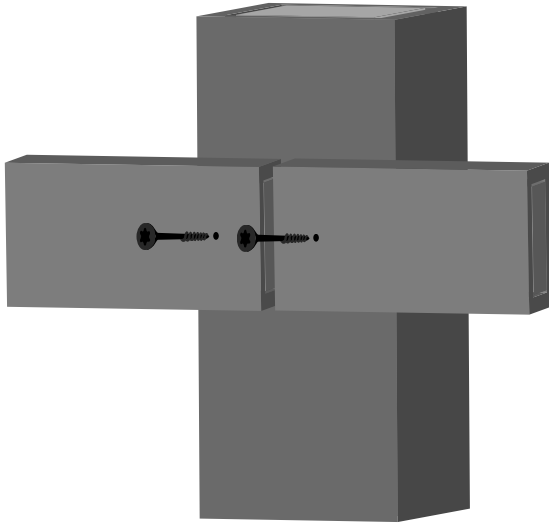

NOTE: For sloping landscape, angle cut rail ends.

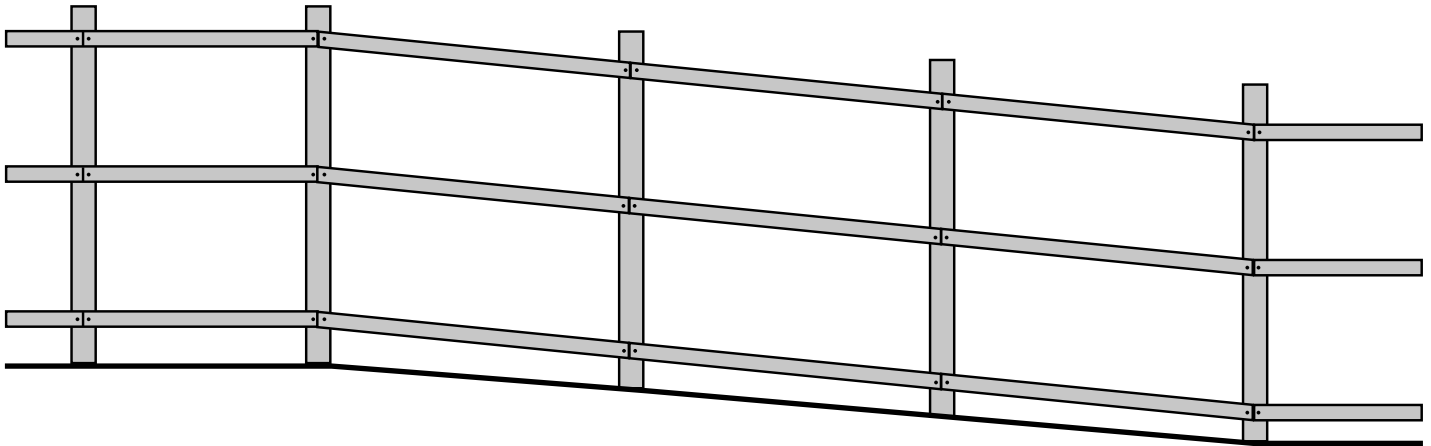

STAPLES

Holding the staple gun sideways, shoots 4 staples in a box pattern in each “picket and cross rail intersection” so the staples hide vertically in the grain of the picket. To prevent staple buckling when fired into pickets, go slow, push the staple gun firmly and make sure the fence panel is not bouncing back towards the gun. Shorter 1 1/4 in., 16 gauge staples are also used frequently in low-temperature installation to help prevent staple buckling. Set air-compressor to 90-100 PSI.

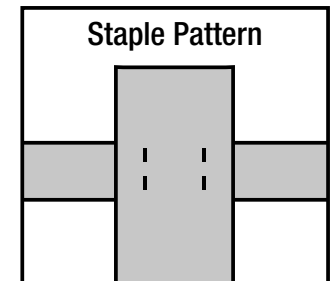



Traditional (semi-private)

Dog-ear Picket 4 5/8 in. x 69 in.
Square Top Picket 6 5/8 in. x 69 in.



TRADITIONAL PICKET STYLE

It is important to leave a 1/8 in. space in between each picket. A minimum of 1/8 in. picket spacing is a necessary precaution to avoid the thermal expansion of the pickets, from pushing into each other and building pressure. A small space in between the pickets will prevent the pickets from ever touching. The Traditional Picket Style is more of a semi-private fence.

- 1/8 in. spacing between pickets.
- Pickets install 2 in. above the ground
- Staples 1 1/2 in. Galvanized or Stainless Steel, 4 staples per picket and rail crossing

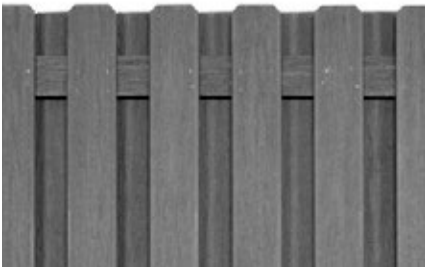
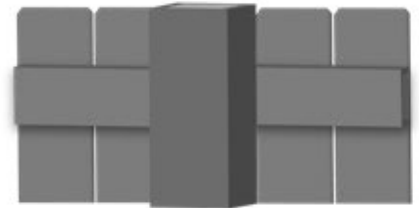

Shadow Box (semi-private)

Dog-ear Picket 4 5/8 in. x 69 in.
Square Top Picket 6 5/8 in. x 69 in.



SHADOW BOX PICKET STYLE

For an easier semi-private installation, we recommend a “Good Neighbor” Shadow box Picket Style. You don’t need to be precise with the spacing, and it looks great from both sides.

- Spread pickets evenly across both sides of rail
- Pickets install 2 in. above the ground
- Staples 1 1/2 in. Galvanized or Stainless Steel, 4 staples per picket and rail crossing



Board on Board (private)

Dog-ear Picket 4 5/8 in. x 69 in.
Square Top Picket 6 5/8 in. x 69 in.



BOARD ON BOARD PICKET STYLE

Board on Board is a full privacy fence. It’s the strongest picket style of the 3, with all of the pickets stapled together in an overlapping picket method. The Board on Board picket style is also the easiest to install. You don’t need precise spacing, plus during the entire installation you only need to stand on one side of the fence. Normal spacing between pickets is 2 3/4 in.

- Spread pickets evenly overlapping on 1 side of rail
- Pickets install 2 in. above the ground
- Staples 1 1/2 in. Galvanized or Stainless Steel, 4 staples per picket and rail crossing

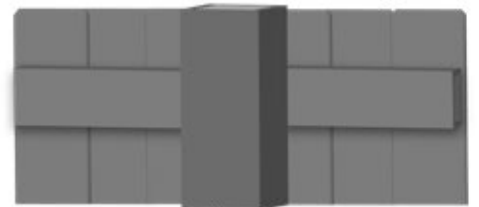

Gate Frame Kit Installation

Follow the Gate Frame Kit instructions in the box to install each gate. All hardware is included. Use 1 gate frame kit for a single gate; use 2 gate frame kits for a double drive gate. Gates are designed to “swing in.” Gate pickets need a minimum of 4 in. above the ground grade to swing properly. Pickets should be installed in a single layer Tradition Picket Style row for gates only. Shadow Box and Board on Board Styles add too much extra weight to the frame and hinges of the gate. In general, the shorter and lighter it is, the stronger the gate will be. Gates that exceed 4 1/2 feet wide require a support wheel for weight distribution and stability. Attach the support wheels directly to the metal gate frame kit only. Support wheels are sold separately.

Helpful Tips for Face Mount Fence Styles

1. The Board on Board is the only style that provides tight visual privacy and is relatively easy to install.
2. Shadow Box provides a similar look on either side of the fence, thus the name “Good Neighbor.” Some communities require a “same look” on each side.
3. While we recommend 17 Dog-ear and 13 Square Top pickets for the Shadow Box and/or the Board on Board, you can use more than that to achieve a “tighter look,” reducing the spacing between the pickets. This especially changes the Shadow Box look.
4. The recommended gap of 1/8 in. (it can be more than 1/8 in. if you wish) between the pickets in the Traditional “one sided” is not optional but necessary to accommodate possible thermal expansion.
5. In a typical fence run, it is common to have sections less than 6 ft. We recommend a symmetrical look when possible. E.G. a 20 ft. run could be 6 ft. - 6 ft. - 6 ft. - 2 ft., however 4 ft. - 6 ft. - 6 ft. - 4ft. would look better. In a 10 ft. run, 2 each 5 ft. sections usually looks better than a 6 ft. and a 4 ft.
6. Sometimes it becomes necessary to rip a picket to fill a space, at the end of the fence. If you see that you will need to rip a picket, it always looks better to rip more than one. The material is easy to rip with a standard table saw. E.G. if a short section will require a 2 inch filler strip to complete the infill, instead of making an ugly 2 in. filler, rip 1/2 in. off 4 pickets and scatter the slightly more narrow ripped pickets throughout the section. The eye won’t notice and the fence will look great.
7. Use the recommended gravel and concrete quantities, don’t “cheat below the ground.” The gravel isn’t just for drainage, it also provides a base for the fence foundation.
8. It looks best if all post tops hide 1-3 inches below the top line of the pickets. This means the maximum post heights should be 70 in. above grade as the fence top remains parallel to the ground - flat, upgrade, or down-grade. The goal is to hide all of the posts behind the view of the pickets.
9. Your fence will settle a bit, keep the picket bottoms up off the ground or they will buckle. Recommended distance is 2 in.

Warranty

15 & 10 YEAR PERFORMANCE LIMITED WARRANTY

WHAT IS COVERED

Fiberon Fencing is backed by a 15-year limited pro-rated warranty on fence pickets and backer rails. Fence posts are covered by a 10-year limited pro-rated warranty. When installed correctly, your composite fencing is guaranteed to remain free from rot, fungal degradation, checking, splintering and delamination.

Fiberon Fencing is a system of pickets, rails, and posts and must be installed according to guidelines to validate the warranty. Substitution of wood or other materials for any portion of the system will void the warranty.

WHAT IS NOT COVERED

In no event will the manufacturer be liable for any direct, indirect, incidental, special, consequential, punitive, exemplary, statutory, special, or other, damages based upon the manufacturer products or manufacturer fasteners or resulting, directly or indirectly, from any defect in the manufacturer products or fasteners, including but not limited to damage to, diminution in value of and/or loss of use or enjoyment of, any property or part thereof, whether based on contract, tort, strict liability, statute, regulation or otherwise, even if the manufacturer is expressly advised about the possibility of such damages. Some states do not allow the exclusion or limitation of incidental or consequential damages in certain circumstances, so the above limitation may not apply to you.

In addition, this Limited Warranty does not cover and the manufacturer shall not be liable for any installation, removal or reinstallation costs. The manufacturer does not warrant against and is not responsible for, and no express or implied warranty shall be deemed to cover, any condition attributable to: (1) improper installation of products and/or failure to abide by the manufacturer's written instructions and any applicable laws or building codes, including but not limited to improper structural support, fastening, ventilation or gapping; (2) use of the manufacturer's products beyond normal use or in an application not recommended or permitted by the manufacturer's written instructions and applicable laws and building codes; (3) movement, distortion, collapse or settling of the ground or the supporting structure on which the manufacturer's products are installed; (4) Defects in or failure arising from decking structure resulting from water caused by improper installation, workmanship, maintenance or repair; (5) any Act of God (including but not limited to flooding, hurricane, tornado, wind, earthquake, lightning, hail, etc.); (6) discoloration, fading, spotting or staining from or caused, in whole or in part, by mold, mildew, other fungal growth, organic materials, metallic oxides or particles (including but not limited to rust or corrosion of any fasteners), dirt, other atmospheric or environmental pollutants, foreign substances such as grease or oil, chemicals (including but not limited to those found in cleaners), or normal weathering (defined as natural efflorescence, exposure to sunlight, weather and atmospheric conditions which causes any colored surface to gradually fade, flake, chalk, or accumulate dirt or stains); (7) damage resulting from casualty, fire or exposure to heat sources such as cooking devices or retro-reflective surfaces; (8) the application of paints, stains, surface treatments or other chemical substances including but not limited to cleaners or pesticides; (9) fading, flaking or other deterioration of any paints, stains or other coatings placed on the manufacturer's products; (10) climate change, environmental conditions, static electricity or any cause beyond the control of the manufacturer; (11) variations or changes in color of the manufacturer's products; (12) improper handling, maintenance, storage, abuse or neglect of the manufacturer's products by Purchaser or others; (13) ordinary wear and tear; (14) impact from objects; or (15) any fasteners not supplied or approved by the manufacturer.

No warranty is given with respect to any fasteners other than the fasteners produced by the manufacturer. Other fasteners, whether approved fasteners or otherwise, are subject to only the warranties provided by the manufacturer of the fastener and Purchaser's sole warranty and remedy is with that manufacturer.

Contact the Customer Service Team at 1-800-215-2740 or visit www.FIBERONFENCING.com.

4 5/8" Dogear Good Neighbor Shadowbox Face Mount
 68 Inch Post Center-to-Center

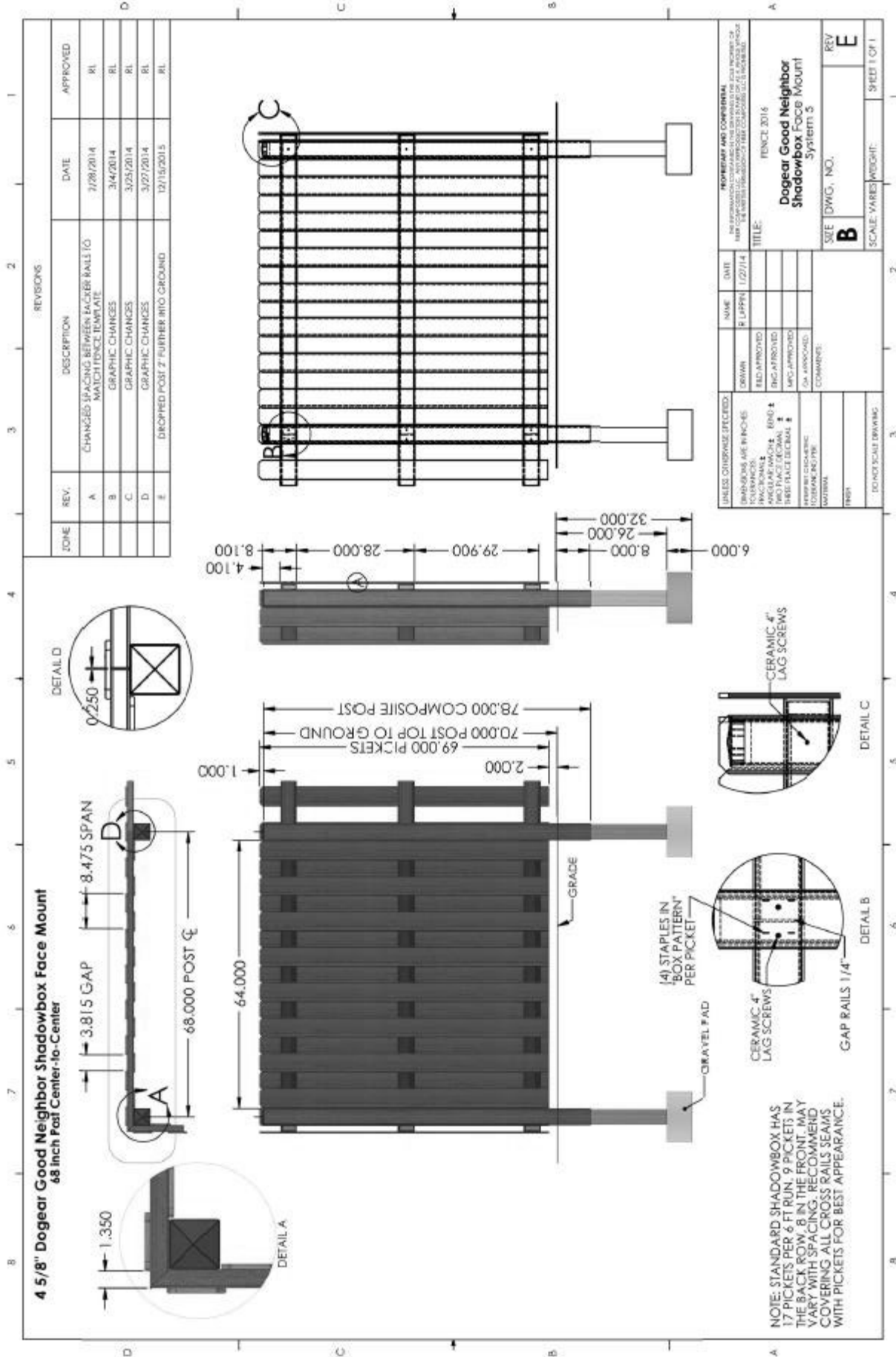

REVISIONS				
ZONE	REV.	DESCRIPTION	DATE	APPROVED
	A	CHANGED 18 PICKETS BETWEEN LAGNER RAILS TO MATCH FENCE TEMPLATE	7/29/2014	RL
	B	GRAPHIC CHANGES	3/4/2014	RL
	C	GRAPHIC CHANGES	3/25/2014	RL
	D	GRAPHIC CHANGES	3/27/2014	RL
	E	DROPPED POST Z' FURTHER INTO GROUND	12/15/2015	RL

UNLESS OTHERWISE SPECIFIED:		NAME	DATE
SHADOWBOXES ARE 6" HIGH	DRAWN	R. LIPPEN	12/27/14
ALL DIMENSIONS ARE IN INCHES	REV. APPROVED		
FRAMES ARE TO BE MADE OF 1 1/2" X 3" X 1/2" ALUMINUM	ENG. APPROVED		
FRAMES ARE TO BE MADE OF 1 1/2" X 3" X 1/2" ALUMINUM	MFG. APPROVED		
	QA APPROVED		
	COMMENTS		
FINISH		SIZE DWG. NO.	
DO NOT SCALE DRAWING		SCALE: VARSIES/WEIGHT:	
		REV	
		E	
		SHEET 1 OF 1	

PROFESSIONAL AND CONFIDENTIAL
 INFORMATION CONTAINED HEREIN IS THE PROPERTY OF DOG EAR GOOD NEIGHBOR SYSTEMS, INC. AND IS TO BE USED ONLY FOR THE PROJECT AND SITE SPECIFICALLY IDENTIFIED HEREIN. ANY REPRODUCTION OR DISTRIBUTION OF THIS INFORMATION IS STRICTLY PROHIBITED.

PROJECT: FENCE 2016
 TITLE: Dogear Good Neighbor Shadowbox Face Mount System 3
 SIZE DWG. NO. B
 SCALE: VARSIES/WEIGHT: E
 REV E

NOTE: STANDARD SHADOWBOX HAS 17 PICKETS PER 6 FT RUN; 9 PICKETS IN THE BACK ROW, 8 IN THE FRONT. MAY VARY WITH SPACING. RECOMMEND COVERING ALL CROSS RAILS SEAMS WITH PICKETS FOR BEST APPEARANCE.

6 5/8" Square Top Board on Board Face Mount
 68 inch Post Center-to-Center

ZONE	REV.	DESCRIPTION	DATE	APPROVED
	A	CHANGED SPACING BETWEEN PICKETS RAIL TO MATCH FENCE TEMPLATE	2/28/2014	RL
	B	GRAPHIC CHANGES	3/4/2014	RL
	C	GRAPHIC CHANGES	3/25/2014	RL
	D	GRAPHIC CHANGES	3/27/2014	RL
	E	DROPPED POST 2" FURTHER INTO GROUND	12/15/2015	RL

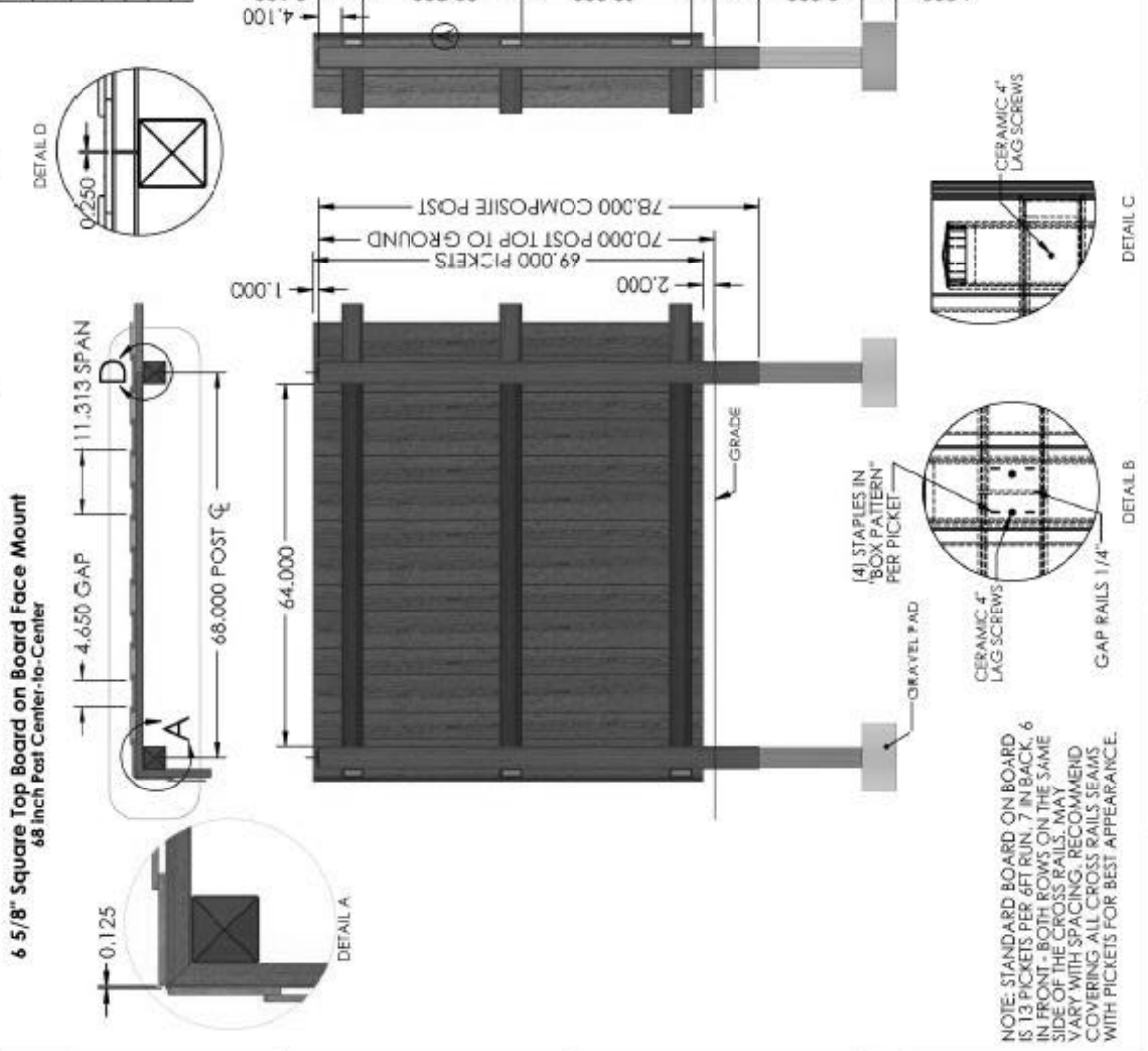

UNLESS OTHERWISE SPECIFIED:
 DIMENSIONS ARE IN INCHES.
 FINISHES:
 * ALL SURFACES TO BE PAINTED
 * TWO FACE DECOR
 * THREE FACE DECOR
 * FOUR FACE DECOR
 * FIVE FACE DECOR
 * GRAVEL PAD

REVISIONS

DATE: 1/27/14
 DRAWN: R LUPPH
 CHECKED: [blank]
 ENG APPROVED: [blank]
 MFG APPROVED: [blank]
 QA APPROVED: [blank]
 COMPANY: [blank]

PROJECT AND COMPONENT: FENCE 2016
 TITLE: Square Top Board on Board Face Mount System 11
 SITE: [blank]
 DWG. NO.: B
 REV: E
 SCALE: VARSIES
 SHEET 1 OF 1

DO NOT SCALE DRAWING

6 5/8" Square Top Good Neighbor Shadowbox Face Mount
68 inch Post Center-to-Center

REVISIONS									
ZONE	REV.	DESCRIPTION	DATE	APPROVED					
	A	CHANGED SPACING BETWEEN FACE RAILS TO MATCH FENCE TEMPLATE	2/26/2014	RL					
	B	GRAPHIC CHANGES	3/4/2014	RL					
	C	GRAPHIC CHANGES	3/25/2014	RL					
	D	GRAPHIC CHANGES	3/27/2014	RL </tr <tr> <td></td> <td>E</td> <td>DROPPED POST 2" FURTHER INTO GROUND</td> <td>12/15/2013</td> <td>RL</td> </tr>		E	DROPPED POST 2" FURTHER INTO GROUND	12/15/2013	RL
	E	DROPPED POST 2" FURTHER INTO GROUND	12/15/2013	RL					

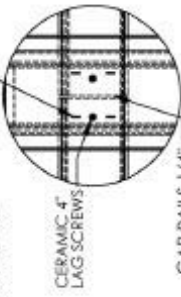
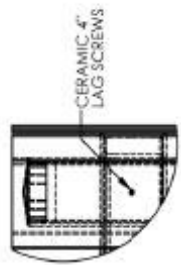
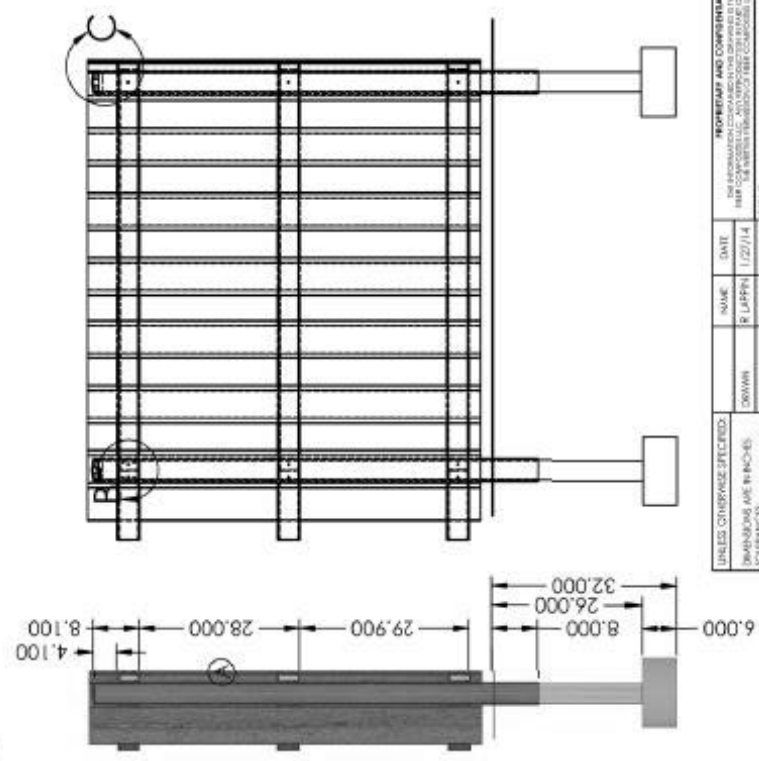
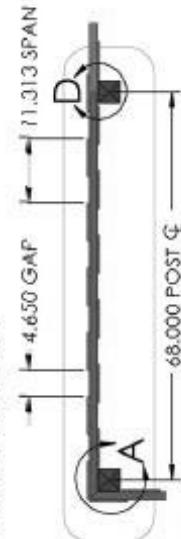

NOTE: STANDARD BOARD ON BOARD IS 13 PICKETS PER 6 FT RUN. 7 IN BACK, 6 IN FRONT - BOTH ROWS ON THE SAME SIDE OF THE CROSS RAILS. MAY VARY WITH SPACING. RECOMMEND COVERING ALL CROSS RAILS SEAMS WITH PICKETS FOR BEST APPEARANCE.

UNLESS OTHERWISE SPECIFIED:		DRAWN		DATE		REVISIONS AND COMMENTS	
REFERENCES:	FINISH	DRAWN	R LAPPY	1/27/14	THE INFORMATION CONTAINED HEREIN IS PROVIDED BY THE JOINT PROPERTY OF THE MEMBER COMPANIES AND IS NOT TO BE REPRODUCED OR TRANSMITTED IN ANY FORM OR BY ANY MEANS, ELECTRONIC OR MECHANICAL, INCLUDING PHOTOCOPYING, RECORDING, OR BY ANY INFORMATION STORAGE AND RETRIEVAL SYSTEM.		
FACE RAILS	CRAYEL PAD	REV. APPROVED			TITLE:		
FACE PICKETS	GRAVEL PAD	ENG. APPROVED			Square Top Good Neighbor		
FACE STAPLES	CRAYEL PAD	MFG. APPROVED			Shadowbox Face Mount		
CROSS RAILS	CRAYEL PAD	ON-APPROVED			System 7		
CROSS PICKETS	CRAYEL PAD	COMPARIS.			SITE DWG. NO.		
CROSS STAPLES	CRAYEL PAD				REV		
MATERIAL					SCALE: VARS: WEIGHT:		
					SHEET 1 OF 1		



6 5/8" Square Top Traditional Face Mount
 68 inch Post Center-to-Center

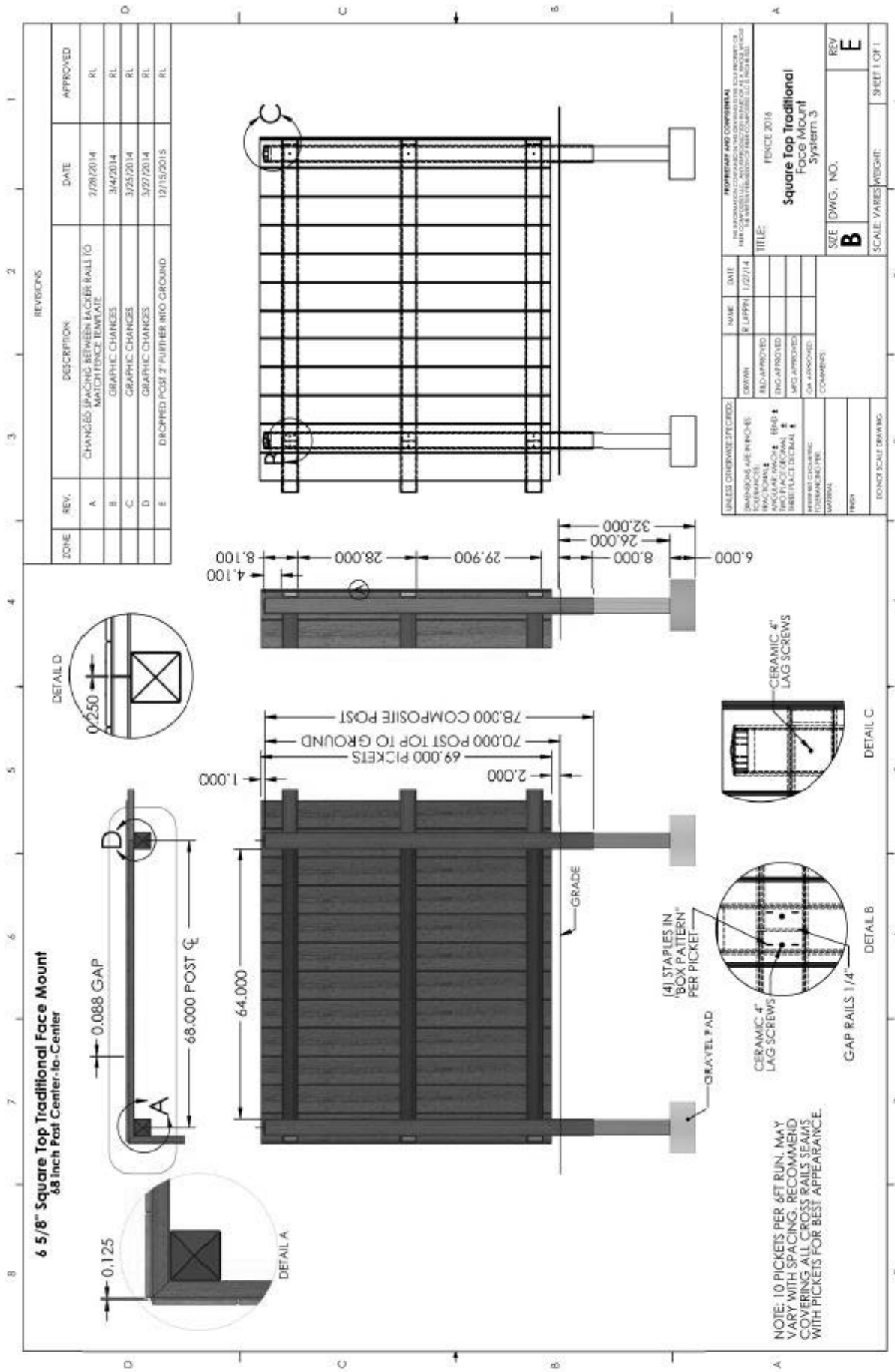

REVISIONS

ZONE	REV.	DESCRIPTION	DATE	APPROVED
	A	CHANGED SPACING BETWEEN FACE RAILS TO MATCH FENCE TEMPLATE	2/26/2014	RL
	B	GRAPHIC CHANGES	3/4/2014	RL
	C	GRAPHIC CHANGES	3/25/2014	RL
	D	GRAPHIC CHANGES	3/27/2014	RL
	E	DROPPED POST 2" FURTHER INTO GROUND	12/15/2015	RL

UNLESS OTHERWISE SPECIFIED:		NAME		DATE	
DIMENSIONS ARE IN INCHES	FINISHES	DESIGNED BY	J. LUPPH	1/27/14	
FRAC TIONS	1/8" = 1/8"	DECLARED BY			
1/16" = 1/16"	1/16" = 1/16"	ENG. APPROVED			
3/16" = 3/16"	3/16" = 3/16"	MFG. APPROVED			
1/2" = 1/2"	1/2" = 1/2"	QA APPROVED			
1" = 1"	1" = 1"	COMMENTS			

PROPERTY AND CONFIDENTIALITY NOTICE: THIS DRAWING IS THE PROPERTY OF FENCE TOP TRADITIONAL. IT IS TO BE USED ONLY FOR THE PROJECT AND SITE SPECIFICALLY IDENTIFIED HEREON. IT IS NOT TO BE REPRODUCED OR TRANSMITTED IN ANY FORM OR BY ANY MEANS, ELECTRONIC OR MECHANICAL, INCLUDING PHOTOCOPYING, RECORDING, OR BY ANY INFORMATION STORAGE AND RETRIEVAL SYSTEM, WITHOUT THE WRITTEN PERMISSION OF FENCE TOP TRADITIONAL.

TITLE: FENCE 2016
Square Top Traditional Face Mount System 3

SIZE (DWG. NO.): B
 SCALE: VARS/WGHT: E
 SHEET 1 OF 1

NOTE: 10 PICKETS PER 6FT RUN. MAY VARY WITH SPACING. RECOMMEND COVERING ALL CROSS RAILS SEAMS WITH PICKETS FOR BEST APPEARANCE.