

PROBRITE™

**ASTRA LED
AREA LIGHT**

**INSTALLATION,
USAGE, & CARE GUIDE**

Model No.	ASTR40-PC-4K-BZ ASTR70-PC-4K-BZ
Mfr. SKU	103-08000002-1 103-08100002-1



Questions? / Missing Parts? / Need Accessories?

Before returning to the store, call or email PROBRITE
Customer Service 9am-5pm EST Monday to Friday.

1-844-507-5651

support@PROBRITE.com

PROBRITE.COM

Visit us online anytime or call us to get information on our product range, download detailed spec & photometric files, find product and mounting accessories, view installation tutorials and videos, and learn about our DLC® rebate eligible products.

Table of Contents

Table of Contents	2	Package Contents.....	4
Safety Information	2	Installation	5
Pre-Installation	3	Operation	9
Planning Installation.....	3	Care & Cleaning	10
Specifications.....	3	Troubleshooting	10
Tools Required.....	3	Warranty	11
Hardware Included.....	4		

Safety Information

IMPORTANT

THIS PRODUCT MUST BE INSTALLED IN ACCORDANCE WITH THE APPLICABLE NATIONAL ELECTRICAL CODE AND LOCAL BUILDING CODES BY A PERSON FAMILIAR WITH THE CONSTRUCTION AND OPERATION OF THE PRODUCT AND THE HAZARDS INVOLVED.

PRECAUTIONS

- Please read and understand this entire manual before attempting to assemble, install, or operate this light fixture.
- This light fixture requires a 120-277Volt AC power source.
- Some codes require installation by a qualified electrician.
- This light fixture must be properly grounded.
- Make sure connections are secure using wire nuts, crimp-on lugs or other approved connecting devices
- This light fixture should be installed outdoors to a wall or a pole.
- This product may contain chemicals known to be hazardous. Thoroughly wash hands after installing, handling, cleaning or otherwise touching the product.

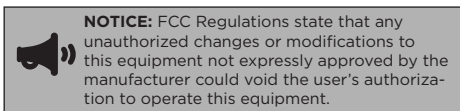
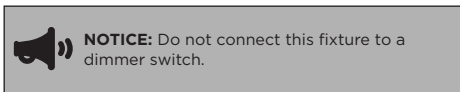
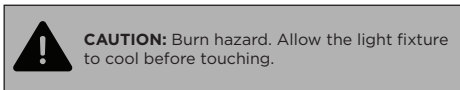
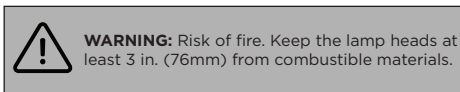
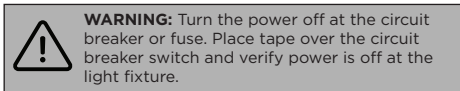

INFORMATION: The device is tested and found to comply with Part 15 of the FCC Rules. Operation is subject to two conditions: (1) This device may not cause harmful interference and, (2) this device must accept any interference received, including any interference that may cause undesired operation.

These limits are designed to provide reasonable protections against harmful interference when the equipment is operated in a commercial environment.

Pre-Installation

PLANNING INSTALLATION

Before installing the light fixture, ensure that all parts are present. Compare parts with the *Hardware Included* and *Package Contents* sections. If any part is missing or damaged, do not attempt to assemble, install, or operate this light fixture.

Estimated installation time: 20 minutes

SPECIFICATIONS

MODEL	ASTRA 40W	ASTRA 70W
Lumens (Light Output)	5000 Lumens	8500 Lumens
Watts (Power Consumption)	40 Watts LED	70 Watts LED
Replaces	150 Watt Metal Halide	250 Watt Metal Halide
Lumens/Watts (Efficacy)	125 lumens per watt	122 lumens per watt
Power Requirements (Input Voltage)	120-277VAC	
Light Color (CCT)	4000 Kelvins (Bright White)	
Dimmable	Non-Dimming (Do not wire to dimming switch)	
Operating Modes	<p>Dusk-to-Dawn: Automatically turns light fixture ON during night and OFF during day.</p> <p>Switch-Controlled: Flip switch to turn light fixture ON and OFF. <i>Use included light sensor cap on fixture's light sensor to utilize this mode setting.</i></p>	

TOOLS REQUIRED

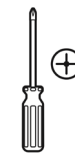

Phillips Screwdriver



Wire strippers/cutters



Circuit tester



Silicone Sealant



Work gloves



Ladder



Wrench



Safety goggles



Power Drill

Pre-Installation (continued)

HARDWARE KIT

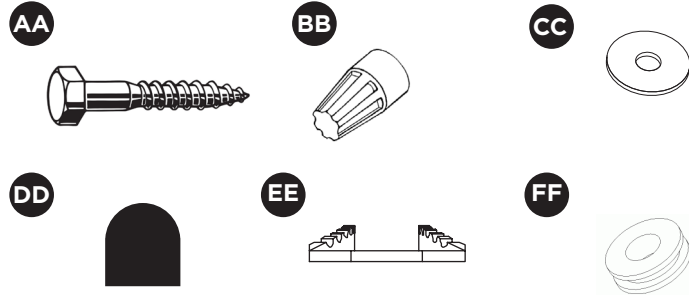
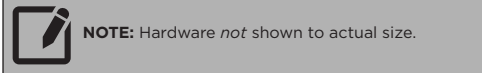

Part	Description	Quantity
AA	Hex Head Lag bolts	3
BB	Wire nut	3
CC	Flat Washers	3
DD	Photocell black cover label	1
EE	Mounting bracket	1
FF	Rubber grommet	1

PACKAGE CONTENTS

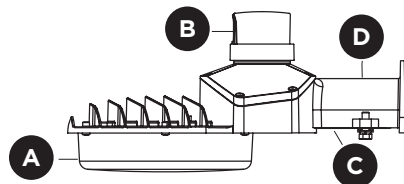

Part	Description	Quantity
A	Light fixture	1
B	120-277V NEMA Twist-lock 3-Pin Photocell (provided separately in the box)	1
C	Wire cover plate	1
D	Fixture arm	1

Installation

1 For best results

- Install light 12-30 feet above the ground.
- Place the photocell (provided separately in the box) on the receptor on top of the fixture and rotate in the direction of the arrow marked on the photocell.
- When mounting fixture, for Dusk to Dawn operation, make sure the photocell is in an area that receives daylight and not too close to reflective surfaces.
- When installing two fixtures on one switch, make sure the switch is rated for at least a 1A inductive load.
- Do NOT wire to dimming switch.
- When mounting to a wall, make sure the fixture is 7 in. on center away from eave and 13 inches on center away from inside

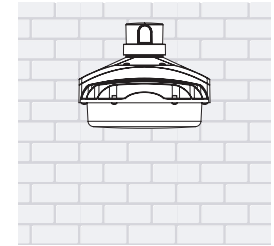

Wall Mount

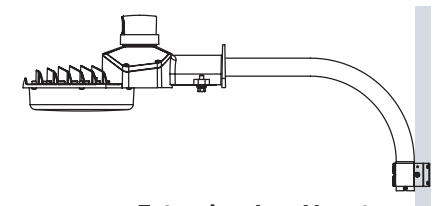

Extension Arm Mount

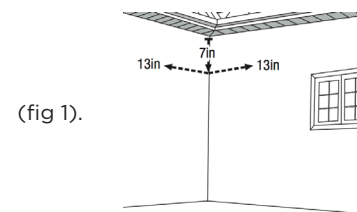

(fig 1).

CAUTION: Do not try to rotate the photocell receptacle on top of the fixture as it may twist the wiring.

NOTE: Make sure the photocell is locked on the receptor. Do not over rotate after it is locked.

2 Shut electric power off

- At wall switch verify it is in the off position (fig 1).
- At the main electrical panel turn off the circuit breaker that supplies power to the outlet box you are working on (fig 2).
- For screw-in type fuses unscrew the fuse that supplies power to the outlet box you are working on (fig 3).



(fig 1).

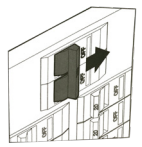

(fig 2).

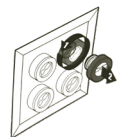

(fig 3).

Installation (continued)

3 Placing photocell on fixture

NOTE: The fixture comes with the twist-lock photocell (B) provided separately in the box.

- Photocell (B) must be inserted into the receptacle for fixture to turn ON.
- **OPTIONAL:** To deactivate Automatic Dusk to Dawn Functionality, place the included photocell cover sticker (DD) on photocell window.
- Place the photocell (B) onto the receptacle on top of the fixture.
- Twist the photocell (B) in the direction of the arrow indicated on the photocell until it locks into place.

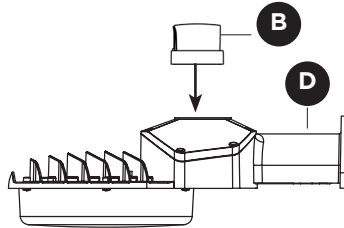

NOTE: The light fixture will not work without the photocell inserted into the photocell receptacle as it completes the circuit.

NOTE: Make sure the photocell is locked on the receptor. Do not over rotate after it is locked.

CAUTION: Do not try to rotate the photocell receptacle on top of the fixture as it may twist

4 Preparing for mounting the fixture

Wall Mount

NOTE: The fixture comes with the wire guard protection plate (C) already installed on the fixture arm (D).

- Remove the wire guard protection plate (C) from the arm (D) of the fixture by loosening the screws.
- Mark and pre-drill the three holes on the desired location of the mounting surface.

Extension Arm Mount

- Remove the wire guard protection plate (C) from the arm (D) of the fixture by loosening the screws.

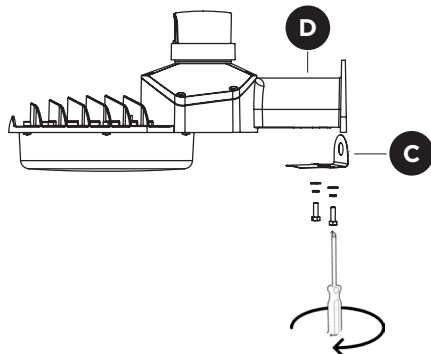

Installation (continued)

5 Mounting the fixture

- Feed supply wires through the arm (D)

Wall Mount

- Attach the fixture to the wall using the three hex head bolts (AA) and the flat washer (CC).

NOTE: Use other suitable bolts or fasteners as applicable to your mounting surface.

TIP: After marking and predrilling the three mounting holes, partially screw the bottom hex bolts with washer and place the fixture's two bottom mounting grooves onto the bottom bolts, then insert the top bolt, and tighten all bolts to firmly secure fixture to surface.

Extension Arm Mount

- Secure the extension arm to the light fixture arm (D) using the included arm mounting bracket (EE) and the screws removed earlier, until the bracket pushes firmly against the arm mount.



IMPORTANT INFORMATION: Extension Arm is available and sold separately. If you need to purchase the extension arm please contact your retail store. Installation instructions for the extension arm are available in the instructions sheet provided in the extension arm package.

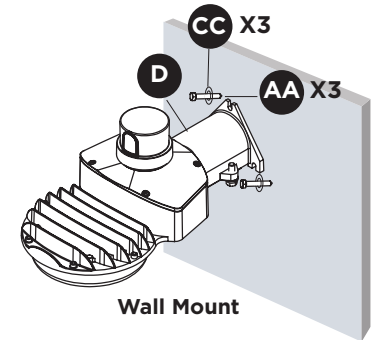

Wall Mount

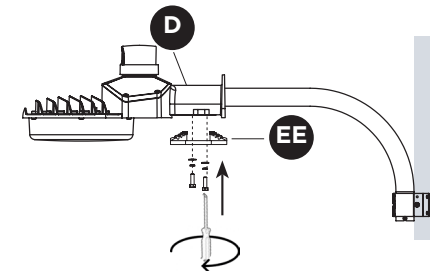

Extension Arm Mount

6 Making the electrical connections

Wall Mount

- Place rubber grommet (FF) into the hole of the wire cover plate before threading wires through.
- Thread the wires through the hole in the wire cover plate (C) before making wiring connections (fig 1).

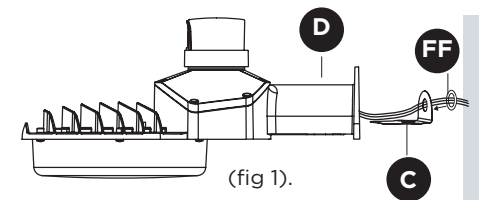

(fig 1).

Installation (continued)

Wall and Extension Arm Mount Electrical Wiring

- If necessary, strip 3/8" of insulation from junction box or fixture (A) wires (fig 1).
- Connect fixture black wire to house black wire, the (+) line, and fixture white wire to house white wire, the (-) common by twisting the exposed wires together and using the wire nuts (BB). Ensure no loose wires.
- Connect house ground wire to the green fixture ground wire, by twisting the exposed wires together and using the wire nuts (BB).

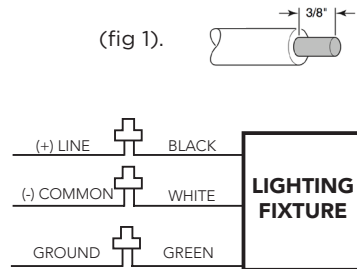

TIP: Hold stripped ends near each other and align any frayed strands (do not twist wires).

Push the wires into wire nut (BB) and use your fingers to twist the wire nut clockwise until tight. Check for tightness by pulling wires.

7 Securing the fixture and wiring

Wall Mount

- Once the fixture is wired, place the wire cover plate (C) on the arm (D) by tightening the two screws and washers removed earlier.

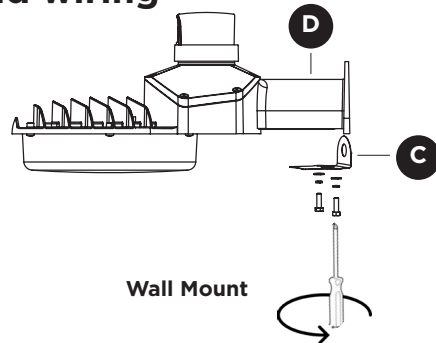

Wall Mount

Extension Arm Mount

- After wiring is complete, secure the fixture on the extension arm using the arm mounting bracket (EE) by tightening the screws and washers removed earlier, until the arm mounting bracket (EE) pushes firmly against the pole.

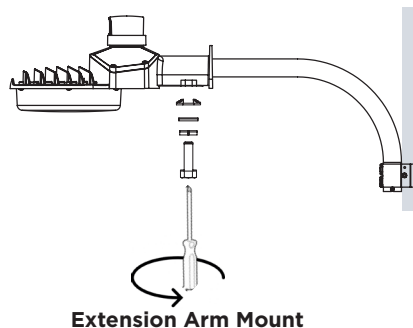

Extension Arm Mount

Operation

1 Selecting Dusk-to-Dawn or Switch-Activated control

OPTION 1: DUSK-TO-DAWN OPERATION

Dusk-to-dawn operation enables the light fixture to automatically turn ON when dark outside and turn OFF when the sun rises, thus saving you energy.

- To enable dusk-to-dawn operation make sure the photocell (B) is exposed to light and is unobstructed.
- Ensure the switch powering the outlet connected to the light fixture is turned to the ON position and *leave it ON* at all times to enable dusk-to-dawn functionality to operate automatically.



TIP: To test if the light fixture (A) and photocell (B) works properly run power to the fixture and cover the photocell to turn fixture ON. Shine a light into the photocell to see if fixture turns OFF.



NOTE: If photocell (B) is located in an area under heavy shade the photocell may not detect enough light and may turn the light fixture on.

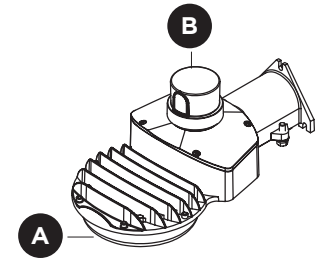

OPTION 2: SWITCH CONTROLLED

Switch controlled operation enables the light fixture to turn ON and OFF by flipping a switch that controls the electricity to the outlet powering the fixture. The light fixture will not turn ON and OFF automatically, but is manually controlled.

- To enable switch activated operation put the black cover label on the photocell.

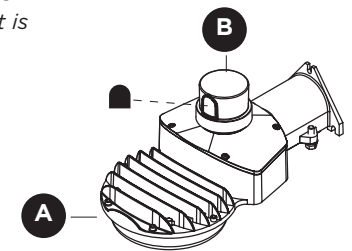
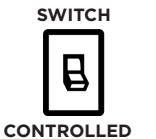

Care and Cleaning

- Shut off main power supply before cleaning the product. To prolong the original appearance, clean the light fixture with clear water and a soft, damp cloth only.
- Do not use abrasive cleaners or cleaners that contain alcohol. Do not apply paints, solvents, or any other chemicals on this light fixture. They could cause a premature deterioration of the finish and may void the warranty.
- Do not spray the light fixture with a hose or power washer.

Troubleshooting

Problem	Possible Cause	Solution
Light does not turn ON	No power to the fixture	Check if circuit breaker is tripped Confirm wall switch is On Verify wiring to fixture is correct (turn power off to fixture beforehand)
	Fixture is sensing daylight	Cover photocell. Wait several seconds until fixture turns ON.
Light cycles ON and OFF continuously	Photocell light sensor is sensing reflected light	Relocate light fixture to a location where there is no reflected light. OR place the optional photocell cover over the photocell light sensor and use the wall switch to turn the light ON and OFF.
Light FLICKERS	The light fixture is wired through a dimmer switch.	Do not use a dimmer switch to control the light fixture. Replace the dimmer with a standard ON/OFF switch.
Light stays ON	Light sensor is in a shaded area	Shine a flashlight into the light sensor and wait a couple minutes. If the light turns OFF, the fixture should be moved to a location with enough light in the daylight hours for the light sensor to work. OR place the optional opaque cover over the photocell light sensor and use the wall switch to turn the light ON and OFF.
	Light Sensor is faulty	If the light does not turn off when a flashlight is shined on the light sensor for a few minutes, then the sensor may be faulty. Please contact customer service.



NOTE: Photocell (B) has a few minute delay, to reduce it's sensitivity to sudden light changes. When testing shine a light/cover the photocell for a few minutes to check if fixture functions properly

5-Year Limited Warranty

This is a limited warranty offered by Probrite for a period of five years from the date of purchase to its customers. Probrite warrants to customers that the products will be free from defects in material and workmanship. The obligation of Probrite under this warranty is limited to the provision of replacement of products and is extended to the original purchaser of the product on presenting valid purchase receipt or other proof of date of original purchase acceptable to Probrite. The receipt is required for rendering the warranty performance. Any warranty claims without original proof of purchase would not be accepted.

It should be noted that the warranty does not apply to Probrite products that have been altered or repaired by unauthorized personnel, have been subjected to neglect, abuse, misuse or accident or damages caused during shipping. Any other products not manufactured by Probrite which have been supplied, installed and/or used in conjunction with Probrite products are not covered under this warranty. Any damages caused by replacements bulbs, LEDs or corrosion or discoloration of brass components are also not covered by this warranty.

Limitation of Liability:

In no event Probrite shall be liable for indirect, consequential, incidental or special damages, or lost profits. Probrite is not liable for any claims or damage arising out of or connected with the manufacture, sale, delivery, use, maintenance and repair or modification of Probrite products, or supply of any replacement parts that, exceed the purchase price of Probrite products giving rise to a claim. Labor charges to remove or install the fixtures will not be accepted.

To Claim:

Please contact PROBRITE customer service at 1-844-507-5651 or email support@PROBRITE.com and include your name, address and contact number, along with a copy of the purchase receipt and a brief description of the problem.

PROBRITE™

Questions? / Missing Parts? / Need Accessories?

Before returning to the store, call or email PROBRITE
Customer Service 9am-5pm EST Monday to Friday.

1-844-507-5651

support@PROBRITE.com

PROBRITE.COM

RETAIN THIS MANUAL FOR FUTURE USE

**Para las translaciones en español,
visit www.probrite.com/install**