

INSTALLATION

Installation Overview

Please read the following installation instructions first after purchasing this product or transporting it to another location.

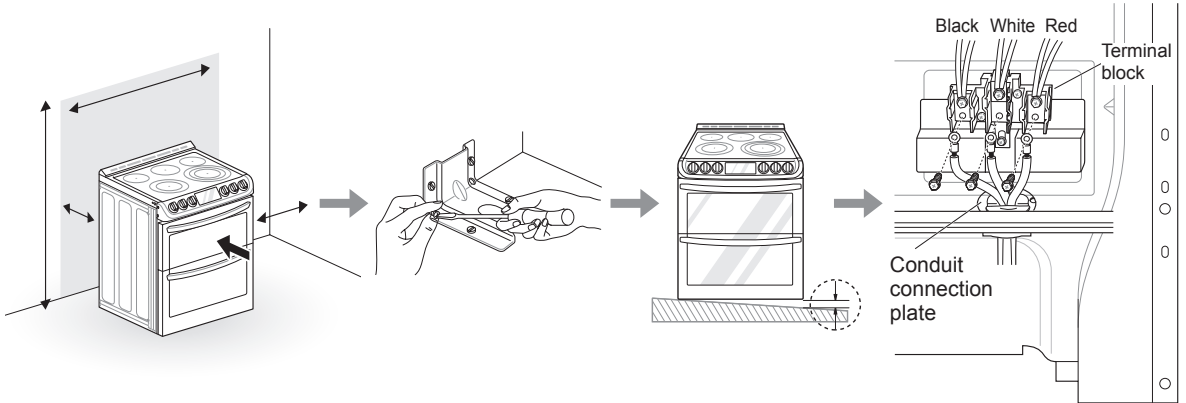

Check and choose the proper location

Install anti-tip device

Level the range

Connect electric range

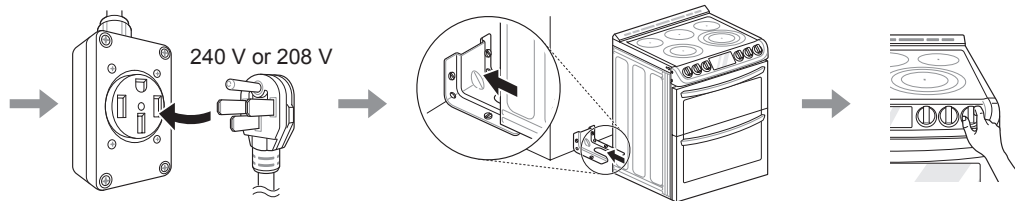

Plug in the power cord

Engage the anti-tip device

Test run

Product Specifications

The appearance and specifications listed in this manual may vary due to constant product improvements.

| Oven Range Models | LTE4815** |
|----------------------------------|--|
| Description | Electric Slide In Oven Range |
| Electrical requirements | 15.5 kW 120/240 VAC or 11.6 kW 120/208 VAC |
| Exterior Dimensions | 29 7/8" (W) x 37 7/8" (H) x 28 15/16" (D) (D with door closed) 75.9 cm (W) x 96.2 cm (H) x 73.5 cm (D) (D with door closed) |
| Height to cooking surface | 36" (91.4 cm) |
| Net weight | 188.7 lb (85.6 kg) |
| Total capacity | Upper Oven: 3.0 cu. ft. Lower Oven: 4.3 cu. ft. Total cap.: 7.3 cu. ft. |

Before Installing the Range

WARNING

Tip - Over Hazard

A child or adult can tip the range and be killed. Verify the anti-tip bracket has been installed. Ensure the anti-tip bracket is engaged when the range is moved.



Do not operate the range without the anti-tip bracket in place. Failure to follow these instructions can result in death or serious burns to children and adults.

If you did not receive an anti-tip bracket with your purchase, call 1-800-984-6306 to receive one at no cost.

WARNING

- **The information in this manual should be followed exactly.** Failure to do so may result in fire, electrical shock, property damage, personal injury, or death.
- **Wear gloves during the installation procedure.** Failure to do so can result in bodily injury.

To check that leveling leg is inserted into anti-tip bracket, grasp the top rear edge of the range and carefully attempt to tilt it forward.

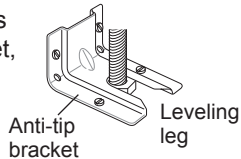

Tools Needed



Phillips screwdriver



Flat-blade screwdriver

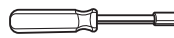

1/4" Nut driver

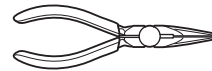

Pliers

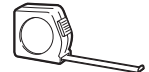

Tape measure



Level



Adjustable wrench



Drill



Safety glasses



Gloves

Parts Provided



Template (1)

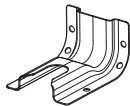

Anti-tip bracket kit (1)



Rear filler (1)

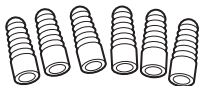

Anchor sleeves (6)



Lag bolts (6)

Parts Not Provided

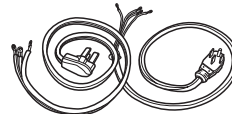

4-Wire cord or
3-Wire cord
(UL approved 40 or 50
AMP)

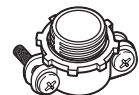

Strain relief
**(For conduit
Installations only)**

NOTE

- Observe all governing codes and ordinances.
- Have the installer show you the location of the circuit breaker or fuse. Mark it for easy reference.
- As when using any appliance generating heat, there are certain safety precautions you should follow.
- Be sure your range is installed and grounded properly by a qualified installer or service technician.

Installing the Range

Unpacking and Moving the Range

CAUTION

- **You should use two or more people to move and install the range. (Excessive Weight Hazard)** Failure to do so can result in back or other injury.
- **Do not use the door handles to push or pull the range during installation or when moving the range out for cleaning or service.** Doing so can result in serious damage to the door of the range.

Remove packing material, tape and any temporary labels from your range before using. Do not remove any warning-type labels, the model and serial number label, or the Tech Sheet that is located on the back of the range.

To remove any remaining tape or glue, rub the area briskly with your thumb. Tape or glue residue can also be easily removed by rubbing a small amount of liquid dish soap over the adhesive with your fingers. Wipe with warm water and dry.

Do not use sharp instruments, rubbing alcohol, flammable fluids, or abrasive cleaners to remove tape or glue. These products can damage the surface of your range.

Your range is heavy and can be installed on soft floor coverings such as cushioned vinyl or carpeting. Use care when moving the range on this type of flooring. Use a belt when moving the range to prevent damaging the floor. Or slide the range onto cardboard or plywood to avoid damaging the floor covering.

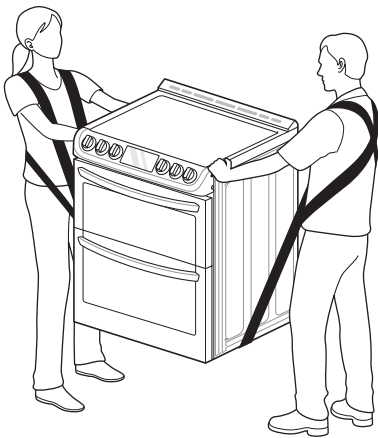

Choosing the Proper Location

CAUTION

- **Avoid placing cabinets above the range.** To minimize the hazard caused by reaching over the open flames of operating burners, install a ventilation hood over the range that projects forward at least five inches beyond the front of the cabinets.
- **Make sure wall covering, countertop and cabinets around the range can withstand the heat (up to 194 °F) generated by the range.** Discoloration, delamination or melting may occur. This range has been designed to comply with the maximum allowable wood cabinet temperature of 194 °F.
- **Before installing the range in an area covered with linoleum or other synthetic floor covering, make sure the floor covering can withstand temperatures of at least 200 °F (93 °C).**
- **Use an insulated pad or 1/4 in. (0.64 cm) plywood under the range if installing the range over carpeting.**

The range should always be plugged into its own individual properly grounded electrical outlet. This prevents overloading house wiring circuits which could cause a fire hazard from overheated wires. It is recommended that a separate circuit serving only this appliance be provided.

Mobile Home - Additional Installation Requirements

The installation of this range must conform to the Manufactured Home Construction and Safety Standard, Title 24 CFR, Part 3280 (formerly the Federal Standard for Mobile Home Construction and Safety, Title 24, HUD Part 280), or when such standard is not applicable, the Standard for Manufactured Home Installations, ANSI A225.1/NFPA 501A or with local codes.

- When this range is installed in a mobile home, it must be secured to the floor during transit. Any method of securing the range is adequate as long as it conforms to the standards listed above.
- A four-wire power supply cord or cable must be used in a mobile home installation.

Dimensions and Clearances

NOTE

Save for the use of the local electrical inspector.

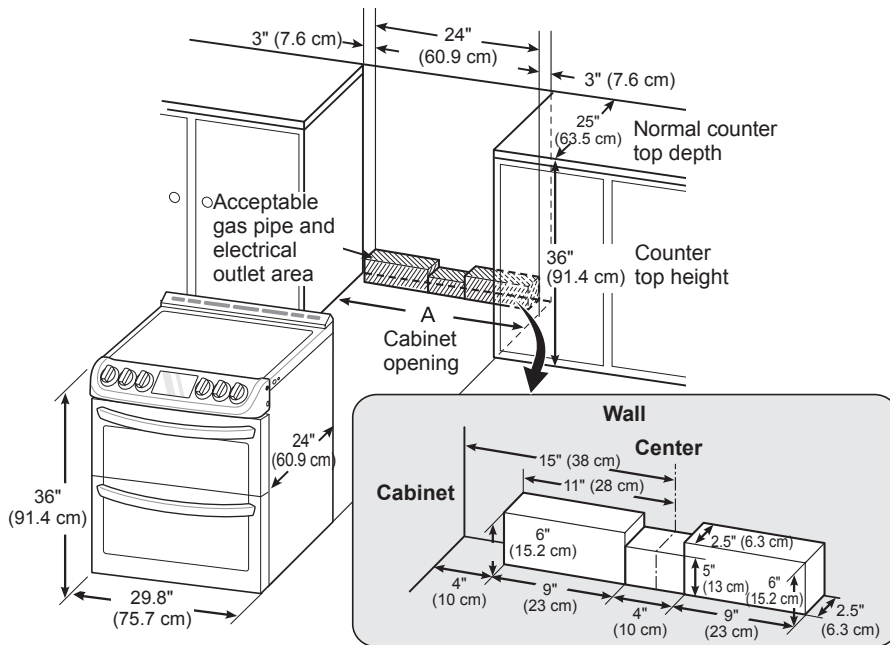

A = 30" (76.2 cm) For U.S.A
 = 30" (76.2 cm) ~ 31" (78.7 cm) For CANADA

For installation in Canada, a free-standing range is not to be installed closer than $15/32$ " (12 mm) from any adjacent surface.

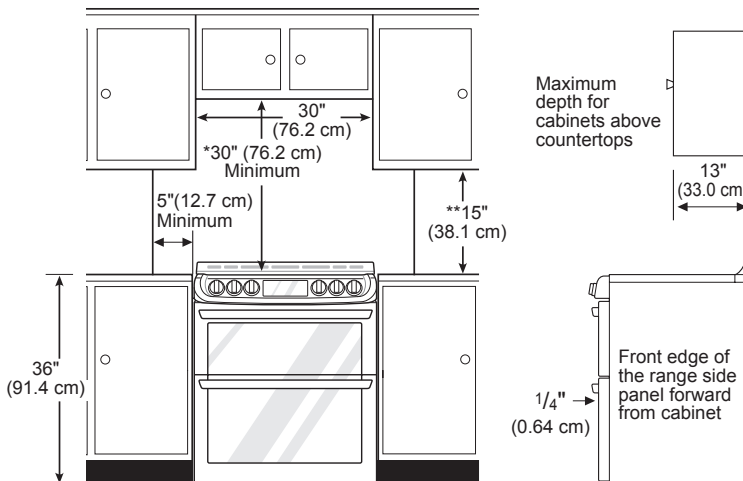

Minimum Dimensions

* 30" (76.2 cm) minimum clearance between the top of the cooking surface and the bottom of an unprotected wood or metal cabinet; or 24" (60.9 cm) minimum when bottom of wood or metal cabinet is protected by not less than $1/4$ " (0.64 cm) flame retardant millboard covered with not less than no. 28 MSG sheet steel, 0.015" (0.381 mm) stainless steel, 0.024" (0.610 mm) aluminum or 0.020" (0.508 mm) copper.

** 15" (38.1 cm) minimum between countertop and adjacent cabinet bottom.

Installing the Anti-tip Device



WARNING

Tip - Over Hazard

A child or adult can tip the range and be killed. Verify the anti-tip bracket has been installed. Ensure the anti-tip bracket is engaged when the range is moved. Do not operate the range without the anti-tip bracket in place. Failure to follow these instructions can result in death or serious burns to children and adults.



To check that leveling leg is inserted into anti-tip bracket, grasp the top rear edge of the range and carefully attempt to tilt it forward.

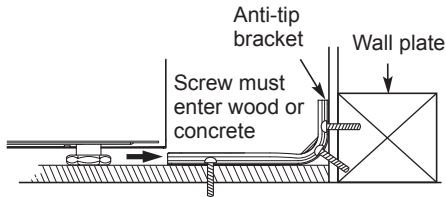
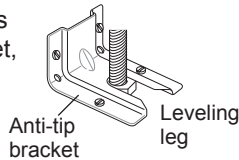

Locate the anti-tip bracket using the template

An anti-tip bracket is packaged with the template. The instructions include necessary information to complete the installation. Read and follow the range installation instruction sheet (template).

Leveling the Range

Level the range by adjusting the leveling legs with a wrench. Extending the legs slightly may also make it easier to insert the rear leg into the anti-tip bracket.

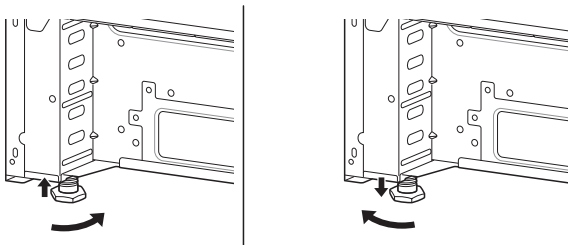

Use a level to check your adjustments. Place the level diagonally on the oven rack, and check each direction for level.

First check direction ①.

Then check direction ②. If the level doesn't show level on the rack, adjust the leveling legs with a wrench.

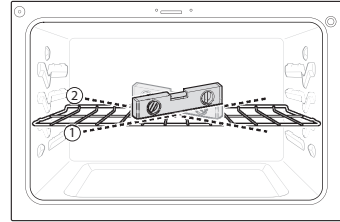

Connecting Electricity

Electrical Requirements

This appliance must be installed and grounded on a branch circuit by a qualified technician in accordance with the National Electrical code ANSI/NFPA NO. 70 - latest edition.

All wiring should conform to Local and NEC codes. This range requires a single-phase, 3 wire, A.C 120/208 V or 120/240 V 60 Hz electrical system. Use only a 3-conductor or a 4-conductor UL - listed range cord with closed-loop terminals, open-end spade lugs with upturned ends or similar termination. Do not install the power cord without a strain relief.

A range cord rated at 40 amps with 120/240 minimum volt range is required. If a 50 amp range cord is used, it should be marked for use with $1\frac{3}{8}$ " diameter connection openings. This appliance may be connected by means of a conduit or power cord. If a conduit is being used, go to page 17 for **3 wire conduit connections** or **4 wire conduit connections**.



⚠ WARNING

- Allow 2 to 3 ft (61.0 cm to 91.4 cm) of slack in the line so that the range can be moved if servicing is ever necessary.
- The power supply cord and plug should not be modified. If it will not fit the outlet, have a proper outlet installed by a qualified electrician.
- Using an extension cord to connect the power is prohibited. Connect the power cord and plug directly.
- Electrical ground is required on this appliance.
- Make sure that the power cord is not pinched by the range or heavy objects. Failure to do so can result in serious burns or electrical shock.

Specified power-supply-cord kit rating

| Range rating, watts | | Specified rating of power supply-cord kit, amperes | Diameter (inches) of Range connection Opening | |
|-------------------------|-------------------------|--|---|---------|
| | | | Power cord | Conduit |
| 120/240 volts 3-wire | 120/208 volts 3-wire | 40 or 50A | 1 3/8" | 1 1/8" |
| 8,750 - 16,500 | 7,801 - 12,500 | | 1 3/4" | 1 3/8" |
| 16,501 - 22,500 | 12,501 - 18,500 | 50 | | |

3, 4 - Wire electrical wall Receptacle

 **4 Wire receptacle (14-50R)**
 **3 Wire receptacle (10-50R)**

Connecting the Power Cord

The rear access cover must be removed. Loosen the two screws with a screwdriver. The terminal block will then be accessible.

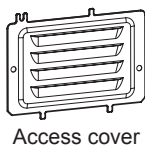

Use the cord/conduit connection plate to install the power cord or conduit. Leave the connection plate as installed for power cord installations. Remove the connection plate for conduit installations and use the smaller 1 1/8 in. (2.8 cm) conduit hole instead of the 1 3/8 in. (3.5 cm) power cord hole.

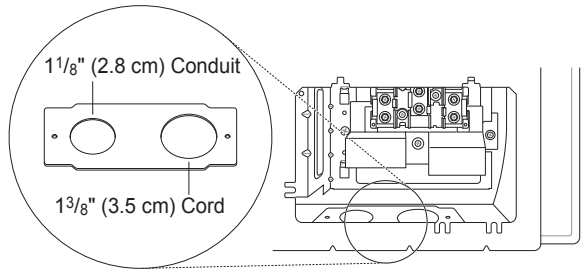

Remove the conduit connection plate

For power cord installations, hook the strain relief over the 1 3/8 in. (3.5 cm) power cord hole located below the rear of the oven. Insert the power cord through the strain relief and tighten it.

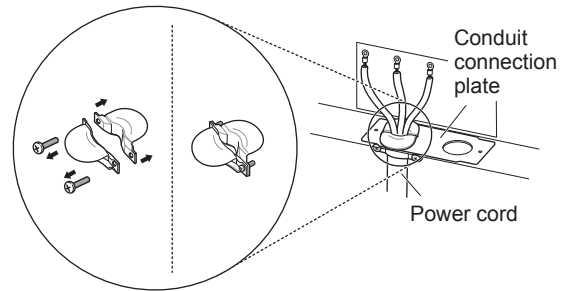

Assembling power cord strain relief at the 1 3/8" opening

For conduit installations, insert the conduit strain relief in the 1 1/8 in. (2.8 cm) conduit hole. Then install the conduit through the body of the strain relief and fasten the strain relief with its ring.

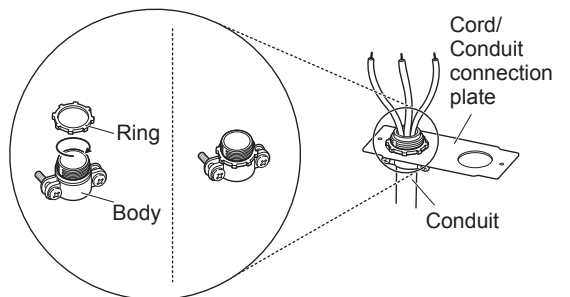

Assembling conduit cord strain relief at the 1 1/8" opening

3-Wire Connection : Power Cord

⚠ WARNING

- The middle (neutral or ground) wire, which is white, of a 3-wire power cord or a 3-wire conduit has to be connected to the middle post of the main terminal block. The remaining two wires of the power cord or conduit have to be connected to the outside posts of the main terminal connection block. Failure to do so can result in electrical shock, severe personal injury or death.

Install the power cord as follows:

For power cord installations, hook the strain relief over the power cord hole (1³/₈"") located below the rear of the oven. Insert the power cord through the strain relief and tighten it.

Do not install the power cord without a strain relief.

- 1 Remove the lower 3 screws from the terminal block and retain them.
- 2 Insert the 3 screws through each power cord terminal ring and into the lower terminals of the terminal block. Make sure that the center (neutral) wire, which is white, is connected to the center lower position of the terminal block.
- 3 Tighten the 3 screws securely into the terminal block. Do not remove the ground strap connections.

3-wire connection

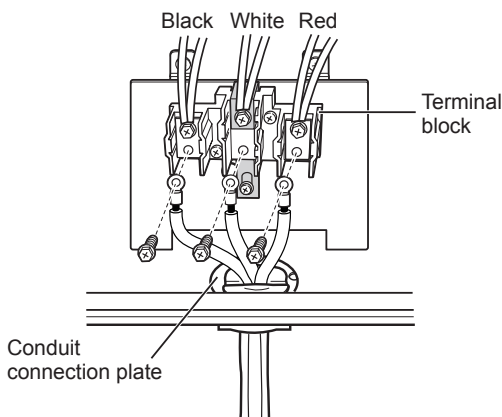

If screws are not tightened securely, it can result in electrical spark and severe personal injury or death.

4-Wire Connection : Power Cord

⚠ WARNING

- Only a 4-conductor power-supply cord kit rated 120/240 volts, 50 amperes and marked for use with ranges with closed-loop connectors or opened spade lugs with upturned ends shall be used. The white middle (neutral) wire of the power cord or 4-wire conduit has to be connected to the middle post of the main terminal block. The other two wires of the power cord or conduit have to be connected to the outside posts of the main terminal connection block. The 4th ground wire (green) must be connected to the frame of the range with the ground screw. Failure to do so can result in electrical shock, severe personal injury or death.

Install the power cord as follows:

Do not install the power cord without a strain relief.

- 1 Remove the lower 3 screws from the terminal block and retain them.
- 2 Remove the ground screw and bend the end of the ground strap up so the slot is over the hole of the center screw removed in step 1.
- 3 Insert the ground screw into the power cord ground wire (green) terminal ring and secure it to the range frame.
- 4 Insert the 3 screws through each power cord terminal ring and into the lower terminals of the terminal block. Make sure that the white center (neutral) wire is connected to the center lower position of the terminal block.
- 5 Tighten the 3 screws securely into the terminal block. The center screw now attaches the bent up ground strap to the block.

4-wire connection

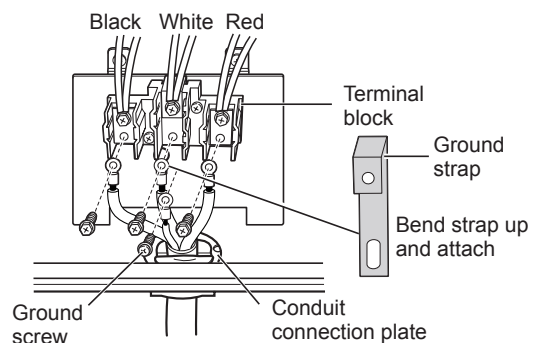

If screws are not tightened securely, it can result in electrical spark and severe personal injury or death.

3-Wire Connection: Conduit

Install the conduit as follows:

Remove the conduit connection plate from the rear of the oven and rotate it. The conduit hole (1 1/8") must be used.

First, prepare the conduit wires as shown below.

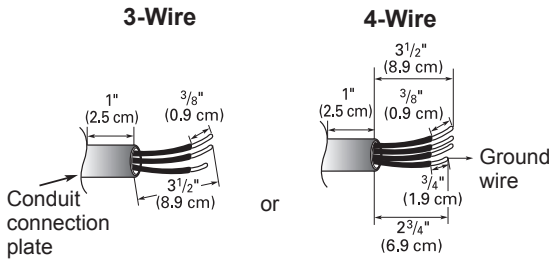

Second, install the conduit strain relief.

For conduit installations, purchase a strain relief and insert it in the 1 1/8 in. (2.8 cm) conduit hole. Then install the conduit through the body of the strain relief and fasten the strain relief with its ring. Reinstall the bracket.

For conduit connections:

If the wire in the conduit is copper it must be 8 or 10 AWG wiring.

If the wire in the conduit is aluminum it must be 6 or 8 AWG wiring.

- 1 Loosen the lower 3 screws from the terminal block.
- 2 Insert the bare wire (white/neutral) end through the center terminal block opening. Do not remove the ground strap connections.
- 3 Insert the two side bare wire ends into the lower left and the lower right terminal block openings. Tighten the 3 screws securely into the terminal block. (approximately 35 - 50 IN-LB)

3-wire connection

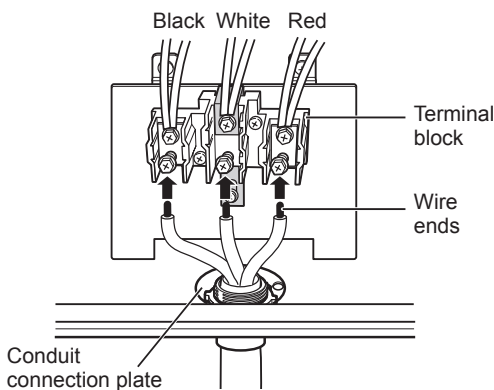

If screws are not tightened securely, it can result in electrical spark and severe personal injury or death.

4-Wire Connection: Conduit

⚠ WARNING

- The white middle (neutral) wire of the power cord or 4-wire conduit has to be connected to the middle post of the main terminal connection block. The other two wires of the power cord or conduit have to be connected to the outside posts of the main terminal connection block. The 4th ground wire (green) must be connected to the frame of the range with the ground screw. Failure to do so can result in electrical shock, severe personal injury or death.

- 1 Follow the instructions for installing the conduit under 3-Wire Connection: Conduit until the strain relief and bracket are installed. Do not install the conduit without a strain relief.
- 2 Loosen the 2 lower left and right screws from the terminal block. Remove the lower 2 center screws. Do not discard any screws.
- 3 Remove the ground screw and bend the end of the ground strap up so the slot is over the hole of the center screw removed in step 1.
- 4 Attach the ground (green) bare wire end to the range frame and secure it in place with the ground screw.
- 5 Insert the bare wire (white/neutral) end through the center terminal block opening. The center screw now attaches the bent up ground strap to the block.
- 6 Insert the two side bare wire ends into the left and the right terminal block openings. Tighten the 3 screws securely into the terminal block. (approximately 35 - 50 IN-LB)

4-wire connection

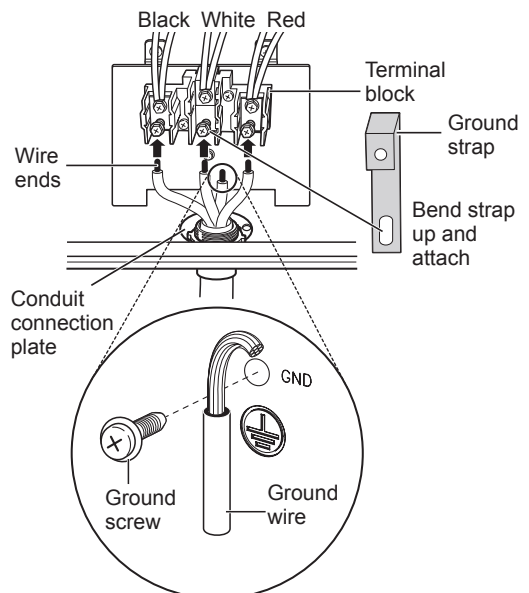

If screws are not tightened securely, it can result in electrical spark and severe personal injury or death.

Engaging the Anti-tip Device

- Move the range close enough to the opening to plug into the receptacle.
- Slide the range into position ensuring that the back leg slides under the anti-tip bracket. The range should sit flush against the back wall when properly installed.
- Carefully attempt to tip the range forward to ensure that the anti-tip bracket is engaged properly. If properly installed, the anti-tip bracket will prevent the range from being tipped. If the range can be tipped, reinstall the range until the anti-tip bracket is properly installed and the range will not tip forward.
- Turn on electrical power. Check the range for proper operation.

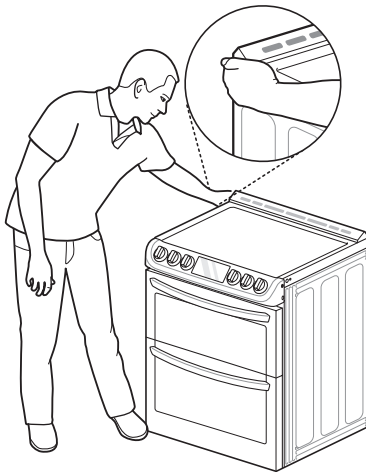

Optional Rear Filler

If the counter does not bridge the opening at the rear wall, use the rear filler kit provided with the slide-in range.

NOTE

If the countertop depth is greater than 25" there will be a gap between the filler kit and the back wall.

If the countertop depth is less than 24", the control panel will not sit flush with the countertop.

Installing the Rear Filler

- 1 Using a screwdriver, remove the upper four screws that attach the rear bracket and loosen the lower two screws.
- 2 Place the rear filler on the rear bracket.
- 3 Tighten the two lower screws on the rear bracket. Insert one of the screws removed in step 1 in the slot at each end of the rear filler.
- 4 Store the remaining two screws with these instructions for future use.

Test Run

Check if the range is properly installed and run a test cycle.

- 1 Press **Upper CLEAR/OFF** and **Lower CLEAR/OFF** to start test
- 2 Turn each knob to the **Hi** position to check that the surface heating elements are working properly. The elements should glow red and radiate heat, and they should cycle on and off periodically even when the knob is in the **Hi** position. This cycling prevents the glass-ceramic from being cracked by thermal shock.
IMPORTANT : The Warming Zone does not consume enough power to glow red.
- 3 After checking all the surface heating elements, check the locking system by pressing **Lower CLEAR/OFF** for three seconds. The oven door should lock and the cooktop should not operate while the Lockout function is turned on. Press **Lower CLEAR/OFF** for three seconds to disable Lockout.
- 4 Now check the oven's operation. Turn the oven mode knob to select the **Bake** mode. 350 °F appears in the display. Press **Start**.
- 5 The oven should finish preheating in 15 minutes, and the convection fan should operate while the oven is preheating.
- 6 After checking the oven's operation, turn the temperature up to 450 °F and leave the oven on for at least an hour to help remove any oil which might cause smoke and odors when first using the oven.

NOTE

Smoke may come out of the range when it is first used.