

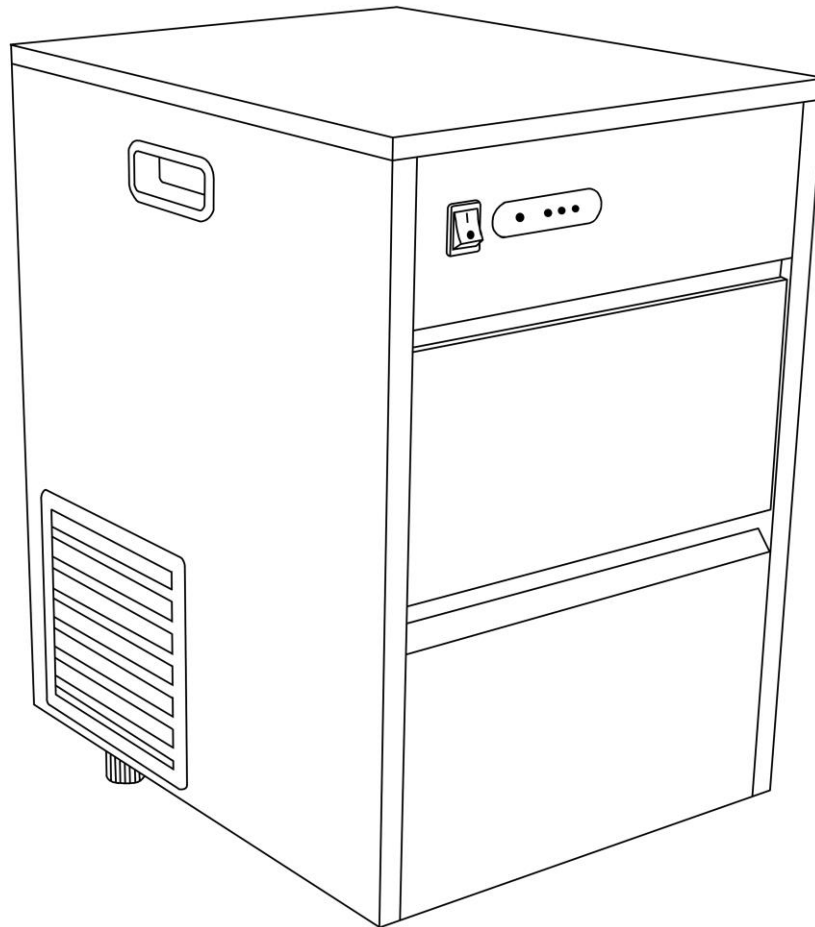

## WHYNTER FREE-STANDING ICE MAKER

**MODEL # : FIM-450HS**

### Instruction Manual



Congratulations on your new WHYNTER product. To ensure proper operation, please read this Instruction Manual carefully before using this product. Keep this manual in a safe place for future reference.

## TABLE OF CONTENTS

---

PARTS AND FEATURES	3
SAFETY PRECAUTIONS	4
REQUIREMENTS	5
OPERATION	6
USING THE CONTROL PANEL	6
INSTALLING THE WATER LINE	7
DRAINING THE UNIT	8
LEVELING THE ICE MAKER	8
CLEANING AND MAINTENANCE	9
SPECIFICATIONS	10
TROUBLESHOOTING	11
WARRANTY INFORMATION	12

## FEATURES

The Whynter FIM-450SS ice maker offers a lot of features such as ice making quickly, great ice making capacity, nice ice shape and ice dropping quickly. Water inlet ~ water filling ~ ice making ~ water releasing and ice dropping, all these processes are automatically controlled for ice making continuously. This free-standing ice maker is the perfect addition to any home for the hot summer months, as this unit can make up to 44 pounds of ice per day and hold up to 7.7 lbs. This is great for hosting events such as BBQs, picnics, birthday parties, and much more. The stainless steel cabinet also gives this ice maker a modern look, which is great if you want to place it in the kitchen, game room, garage, or anywhere else.

In case of water shortage or ice full in cabinet, the indicator on the operation board will light on accordingly and the ice maker will stop operation automatically. The ice storage cabinet is PU foamed, so it is insulated well and it could prevent the ice from melting.

Including a plastic ice scoop, water hose, and drain hose, this ice maker is great for making sure you get the ice you need. The adjustable leveling leg at the bottom of the ice maker allows you to place the unit in any environment without it being uneven. Ideal for any household, this ice maker will be sure to be the hit of the party with your guests.

## PARTS

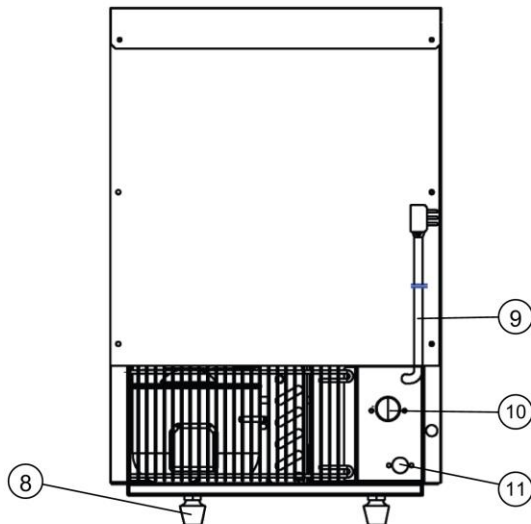
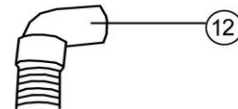
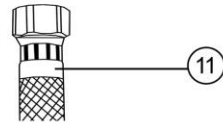
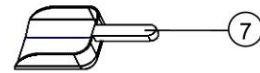
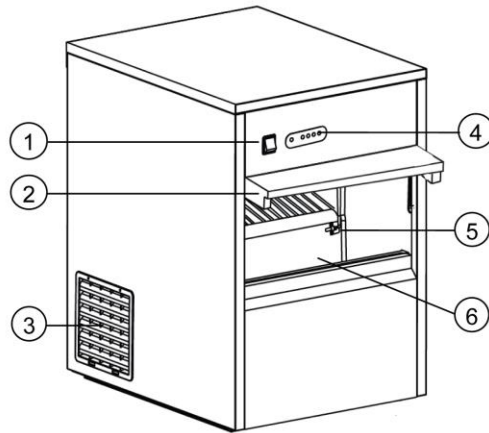

Ice Maker Part
1. Power Switch
2. Ice Maker Door
3. Air Outlet
4. Display Panel
5. Ice Level Sensor
6. Ice Storage Container
7. Ice Scoop
8. Bottom Floor Feet
9. Power Cord
10. Water Inlet Valve
11. Drain Outlet
12. Water Hose
13. Drain Tube

## **⚡WARNING⚡**

TO REDUCE THE RISK OF FIRE, ELECTRICAL SHOCK, OR INJURY WHEN USING YOUR ICE MAKER, FOLLOW THESE BASIC PRECAUTIONS:

- READ ALL INSTRUCTIONS BEFORE USING THE ICE MAKER.
- **WARNING:** RISK OF DANGER TO SMALL CHILDREN AND SMALL ANIMALS. ENTRAPMENT AND SUFFOCATION DANGER IF NOT PROPERLY SECURED. DISPOSED OR ABANDONED APPLIANCES ARE STILL DANGEROUS
- **BEFORE YOU DISPOSE OF YOUR ICE MAKER:** REMOVE THE DOOR TO PREVENT CHILDREN FROM CLIMBING INTO THE UNIT.
- NEVER ALLOW CHILDREN TO OPERATE, PLAY WITH, OR CRAWL INTO THE APPLIANCE.
- NEVER CLEAN ICE MAKER PARTS WITH FLAMMABLE FLUIDS. THE FUMES CAN CREATE A FIRE HAZARD.
- DO NOT STORE OR USE GASOLINE OR ANY OTHER FLAMMABLE VAPORS AND LIQUIDS IN THE VICINITY OF THIS OR ANY OTHER APPLIANCE. THE FUMES CAN CREATE A FIRE HAZARD.

## **SAFETY PRECAUTIONS**

Read all of the instructions before using this appliance. When using this appliance, always exercise basic safety precautions, including the following:

- Do not use if the power supply cord is damaged. If damaged, it must be replaced by qualified technician/electrician.
- Ensure the ice maker is unplugged before cleaning or if not in use.
- To clean the ice maker use only mild detergents or glass cleaning products. Never use harsh chemicals or solvents.
- Do not use this ice maker with an extension cord or power strip. Please ensure that the appliance is plugged directly into the electrical outlet.
- Close the ice maker door immediately after opening.
- Avoid placing the ice maker near external heat sources or direct sunlight.
- Make sure the ice maker is placed on a flat, level, and solid surface.
- Make sure that the surface on which the ice maker is placed is strong enough to hold the ice maker once it is fully loaded with ice.
- The ice maker is an electrical appliance. To avoid serious injury from electrical shock, do not operate the ice maker with wet hands, while standing on a wet surface, or while standing in water.
- Do not expose this appliance to rain or excessive moisture.
- Do not turn the ice maker upside down, on its side, or 45° or more off level.
- Never pull the power cord to disconnect the unit from an outlet. Grasp the plug directly and pull it from the outlet.
- This ice maker is designed for non-commercial use only.
- When use for the first time or when restart after long period of unused, the ice made for the first two times is not edible
- Do not plug this ice maker into the power socket before setup is completed.
- The cord should be secured behind the unit and should not be left exposed or dangling.
- Do not move this ice maker without securing the door.
- Performance may vary based on operational and ambient conditions.



Do not remove any safety, warning, or product information labels from your ice maker.

### **Before you begin**

Preparing the Ice Maker for use before you plug the ice maker in to a power supply, be sure to let it stand upright for at least 24 hours to allow the compressor's oils to settle.

### **Unpacking the Ice Maker**

Carefully remove the packaging materials. Remove any shipping tape and glue from your ice maker before using. Do not use sharp instruments, rubbing alcohol, flammable fluids, or abrasive cleaners to remove tape or glue. These products can damage the surface of your icemaker. Check to make sure the ice scoop and hoses are included. If any parts are missing, please contact our customer service. Put the ice maker on a level and flat surface away from direct sunlight and other sources of heat such as a stove, furnace, radiator, etc. The appliance must be positioned so that the power plug is accessible.

## **REQUIREMENTS**

### **Installation Requirements**

The ice maker has been designed for free-standing installation which will allow you to install the unit in almost any place you desire. Please make sure to follow the instructions for clearance, water and electrical requirements.

### **Clearance and Environment Requirements**

- Choose a well-ventilated area with temperatures above 50°F and below 90°F. Operation outside these temperatures may result in lowered production or may cause other adverse effects.
- This unit **MUST** be installed in an area protected from the elements, e.g., wind, rain, water spray or drips. The icemaker should not be located next to ovens, grills or other high heat sources.
- The unit should be located on a firm and level surface that is able to support the ice maker's total weight with water.
- There must be at least 4 inches of space around the back and sides of the unit for proper air circulation.

### **Water Requirements**

- Only use potable water or water suitable for drinking.
- The temperature of the water should be between 51°F and 90°F.
- Change the water in the water reservoir every 24 hours to ensure a reasonable hygiene level.

Note: The add water light uses an electronic sensor that may not detect purified, filtered, reverse osmosis, or distilled water. You may need to add a pinch of salt to the water to increase the mineral content.

### **Electrical Requirements**

Read all safety precautions listed at the beginning of this manual. It is recommended that a separate circuit serving only your ice maker be provided. Use receptacles that cannot be turned off by a switch or pull chain.

The ice maker is equipped with a power supply cord having a 3-prong grounding plug. To minimize possible shock hazard, the cord must be plugged into a mating 3-pronged and grounding-type wall receptacle providing 110-120V, 60Hz, grounded in accordance with the National Electrical Code and local codes and ordinances. If a mating wall receptacle is not available, it is the personal responsibility of the customer to have a properly grounded, 3-prong wall receptacle installed by a certified electrician.

## OPERATION

# ⚠ WARNING ⚠

Discard the first batch of ice produced by the portable ice maker.  
 Direct sunlight may cause the ice full infrared sensor to malfunction. If the unit continues to produce ice even though the basket is full, you may need to move the unit away from the sunlight

Before using your ice maker, it is strongly recommended to clean it thoroughly. Read and follow the Cleaning and Maintenance section of the manual before proceeding.

Follow the steps below to start using your ice maker.

1. Open the door and remove any packaging tape that may be holding down the ice case, ice shovel, and ice scoop. Remove the ice scoop.
2. Clean the ice storage container.
3. Connect the direct water line into the water inlet valve.
4. Close the door lid.
5. Plug the ice maker's power plug in to a grounded outlet.
6. Press the On/Off power switch on the Control Panel.
7. Ice will be created and fill the ice storage container.

Notes: If the water pump is unable to detect or pump water, the unit will stop automatically, and the "Water Low" indicator will be lit. Make sure that the water line has the correct amount of pressure (water pressure must be a minimum 14.7psi and a maximum of 55psi and restart the unit by pressing the On/Off button twice. The ice maker will continue making ice until the ice basket is full. When the ice basket is full "Ice Full" indicator will be lit

### USING THE CONTROL PANEL

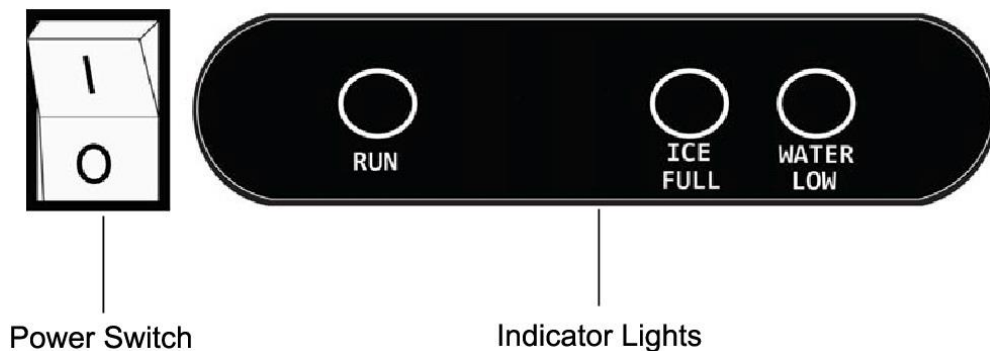

Switch	Function
POWER	Turns the unit on or off

Indicator	Function
RUN	Ice Production is in process.
ICE FULL	Indicates ice basket is full.
WATER LOW	Indicates low water level in water in the reservoir.

### **How the Portable Ice Maker Produces Ice**

After the unit is powered on, the ice maker begins with rotating the ice case into a horizontal water fill position under the evaporator rods. The water pump is engaged and fills the ice case with water. Water overflows for a few seconds before the compressor turns on. The compressor then pumps refrigerant and the fan will turn on automatically after the condenser heats up. The unit will be producing bullet shaped ice around the stainless steel evaporator rods. When the batch of ice has been fully formed, the ice maker stops the freeze cycle and begins the harvest cycle. A valve opens diverting hot refrigerant gas into the evaporator rods. The gas heats the rods, causing the ice cube bullets to slide off the evaporator. The hinged ice case will move out of the way for the formed ice cubes to drop onto the slide and be deposited into the ice bin. The ice case will then resume its horizontal position and be filled with water for the next batch of ice to be made. The ice maker will then produce ice until ice reaches the ice full sensor. The ice bin compartment is insulated, but not refrigerated and the ice in the bin will slowly melt and the water will be reused. Once enough of the ice has melted, the ice maker will automatically start making more ice.

### **Installing the Water Line**

The direct water line can be installed into the ice maker for a continuous flow of water, preventing you from refilling a water tank every time you need more ice.

NOTE: All the required or customized hardware is not provided for installation so it is necessary to hire a professional licensed plumber to complete the installation.

1. Connect the water line to your water source and be sure to tighten the connection to avoid leaking.
2. Hand screw the water line into the water inlet valve on the back of the ice maker.
3. Connect the drainage tube on water outlet valve.
4. Lightly tighten the compression fitting around the water line with an adjustable wrench or similar tool.

### Draining the unit

This unit operates in a gravity drain system which clears excess water from the ice maker to ensure a continuous supply of ice. A water drain hose is provided with this unit. Firmly attach the drain hose to the drain outlet. Please note that the outlet of drain hose should be lower than ice maker so the water can flow out easily.

### Normal Sounds

Your new ice maker may make sounds that are not familiar to you. Most of the new sounds are normal. Hard surfaces like the floor, walls can make the sounds seem louder than they actually are. The following describes the kinds of sounds that might be new to you and what may be making them.

- The ice case motor will make a whirling noise when the ice case and shovel are moving.
- Rattling noises may be produced from the flow of the refrigerant.
- The compressor may make a pulsating or high-pitched sound.
- The compressor may also produce a low tone humming sound.
- Water that is being pumped into the ice case will make trickling, dripping or splashing sounds.
- As each cycle ends, you may hear a gurgling sound due to the refrigerant flowing.
- You may hear fan noise and air being forced over the condenser by the condenser fan.
- During the harvest cycle, you may hear the sound of ice cubes falling into the ice basket.
- If the ice maker is run without water, the water pump will make a screeching noise.

**Note: Do not run the unit without water!**

### Leveling the Ice Maker

It is important for the icemaker to be leveled in order to work properly. It can be raised or lowered by turning the four feet on the bottom of the machine. We recommend using a carpenter's level to check the machine.

1. Place a carpenter's level on top of the product to see if the ice maker is level from front to back and side to side.

2. Adjust the height of the feet as follows:

- Turn the leveling feet to the right to lower that side of the ice maker
- Turn the leveling feet to the left to raise that side of the ice maker.

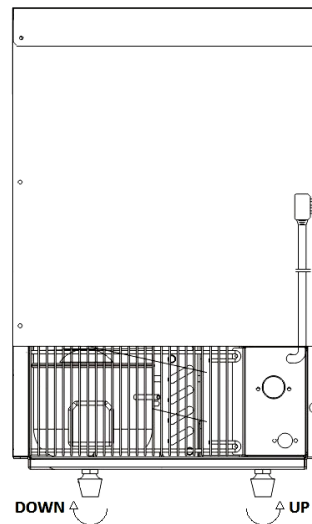



## CLEANING AND MAINTENANCE

The ice maker must be thoroughly cleaned if it has been left unused for a long time

DO NOT turn the ice machine upside down to dry! This will cause the oils from the compressor to shift, which can result in the machine breaking or becoming inoperable.

Periodic cleaning and proper maintenance will ensure efficiency, top performance, and long life.

Never use a solvent-based cleaning agent. These cleaners may transmit taste to the ice cubes, or damage and discolor the interior.

ALWAYS unplug the unit before cleaning the exterior and interior.

**Before using your ice maker, you are strongly recommended to clean it thoroughly.** (This process should clean the unit of any impurities that may have been left behind during the manufacturing process.)

1. Unplug the water line from the ice maker.
2. Clean the interior with a diluted cleaning solution, warm water and a soft cloth. (DO NOT use any caustic or abrasive solutions) (Do not clean your ice maker with flammable fluids.)
3. The outside of the ice maker should be cleaned regularly with a mild detergent and warm water.
4. Dry the interior and exterior with a soft cloth.

### **If the ice has a strange or plastic taste**

If the ice has an unappealing taste, or the unit develops a musty odor, try cleaning the water line of the ice maker with a mild white vinegar solution or lemon juice, and then soak the line in hot water. After that, run a few cycles with plain water to eliminate all traces of the vinegar or lemon juice. Throw out the first two ice batches after cleaning.

If you find the bad taste remains after this procedure, use a solution of 2 tablespoons of baking soda and hot water to soak the water line. Leave overnight to absorb any remaining odors/tastes. Drain the solution, rinse the line with water, and dry the line thoroughly.

### **Routine maintenance**

1. Add a mild cleaning solution mixture to the ice storage container. Use a 10:1 ratio of water to either white vinegar or lemon juice.
2. Scrub the interior of the ice maker (including evaporator rods) with the solution.
3. Remove the water line from the ice maker. Use the solution to clean the water line as well.
3. Drain the solution from the ice maker. Wipe down ice maker interior and water line with hot water.
4. Run the ice maker to make a few batches of ice. Discard the ice.
7. Your ice maker is now clean and should provide clean ice.

If the ice maker will not be used for an extended period of time, you should unplug the unit from power, drain the water from the reservoir and dry the interior with a clean soft cloth.

*Note: Do not touch the power plug when your hands are wet. Note: Never unplug the unit by pulling on the plug.*

## SPECIFICATIONS

Description of product	Portable Ice Maker
Voltage/Frequency	AC 115V~60Hz
Ice-Making / Ice-Harvest rated current	2.5A / 3A
Color	Stainless Steel
Ice Storage capacity	7.7 lbs
Ice-making capability	44 lbs/ day *
Refrigerant	R134a
Dimensions (Width x Depth x Height)	14 7/8" x 18 13/16" x 23 3/16"
Weight	60 lbs

Note: Technical data and performance information provided for reference only.

Specifications are subject to change. Check the rating label on the ice maker for the most accurate information.

\* The actual quantity of ice produced in a 24hour period will vary with room and water conditions.

### Notes on ice storage

The ice maker will automatically shut off when the ice bin is full. The ice bin compartment is insulated, but not refrigerated and the ice in the bin will slowly melt and the water will be reused. Once enough of the ice has melted, the ice maker will automatically start making more ice.

## TROUBLESHOOTING

Many common ice maker problems are easily resolved. Try the troubleshooting suggestions below to see if the problems can be resolved before having to contact the service department.

<b>Problem</b>	<b>Possible Cause</b>	<b>Probable Correction</b>
The machine won't operate.	<ul style="list-style-type: none"> <li>The icemaker is unplugged.</li> <li>The fuse is blown.</li> <li>The icemaker power switch is OFF.</li> <li>The ice storage bin is full of ice.</li> </ul>	<ul style="list-style-type: none"> <li>Plug the ice maker in.</li> <li>Replace fuse.</li> <li>Turn the ice maker power switch to ICE (ON)</li> <li>Take away some ice cubes; make the ice full probe is free of ice.</li> </ul>
The water doesn't feed in after the ice maker starts.	<ul style="list-style-type: none"> <li>The water supply tap is turn off.</li> <li>The water supply pipe is not proper connected.</li> <li>Water press is too low or too high</li> </ul>	<ul style="list-style-type: none"> <li>Turn on the water supply tap.</li> <li>Reconnect the water supply pipe.</li> <li>Adjust water pressure</li> </ul>
Machine makes ice, but bin does not fill up with ice	<ul style="list-style-type: none"> <li>The condenser may be dirty.</li> <li>The air flow to the ice maker may be obstructed.</li> <li>The ambient temperature and water temperature are high, or it is near with some heat source.</li> </ul>	<ul style="list-style-type: none"> <li>Check the installation and make sure there is at least 4" of clearance on each side and back.</li> <li>Run the unit for longer period of time</li> <li>Clean the condenser</li> </ul>
Water is leaking out the unit.	<ul style="list-style-type: none"> <li>A few water droplets are on the door.</li> <li>The water supply connection is leaking.</li> </ul>	<ul style="list-style-type: none"> <li>Under some conditions, humidity may condense on the door. Consider moving the unit or just be more careful when you open the door.</li> <li>Tighten fitting. See "Installing the water line".</li> </ul>
Cubes are partially formed--are white at the bottom.	<ul style="list-style-type: none"> <li>Not enough water in the water bin.</li> </ul>	<ul style="list-style-type: none"> <li>Check if the water supply pressure is correct.</li> <li>Check water supply--filter may be restricted.</li> <li>Check for a water leak at the water trough.</li> </ul>
Noise during operation	<ul style="list-style-type: none"> <li>The feet are not leveled and locked.</li> <li>Certain sounds are normal.</li> </ul>	<ul style="list-style-type: none"> <li>Level and lock the feet. See Leveling the Ice Maker.</li> <li>See "Normal Sounds" section.</li> </ul>
The icemaker stops suddenly while making ice.	<ul style="list-style-type: none"> <li>The electricity is off.</li> <li>The room temperature is out of the stated range.</li> </ul>	<ul style="list-style-type: none"> <li>Reconnect the power supply line.</li> <li>Cut off the electricity and let the ice maker stop working until the temperature returns within the stated range.</li> </ul>
The body of the ice maker is electrified	<ul style="list-style-type: none"> <li>The ground line isn't in the socket.</li> </ul>	<ul style="list-style-type: none"> <li>Use the correct plug and outlet.</li> </ul>
Scale builds up quickly inside the machine.	<ul style="list-style-type: none"> <li>The calcium level in the water is too high.</li> </ul>	<ul style="list-style-type: none"> <li>Use a water softening apparatus installed in front of the water inlet valve.</li> </ul>

### **ONE YEAR LIMITED WARRANTY**

This WHYNTER Ice maker is warranted, to the original owner within the 48 continental states, for one year from the date of purchase against defects in material and workmanship under normal use and service. Should your ice maker prove defective within one year from the date of purchase, return the defective part or unit, freight prepaid (within two months of purchase; after two months to one year, customer will be responsible for freight cost to Whynter's service department), along with an explanation of the claim to Whynter LLC. Please package the ice maker carefully in its original packaging material to avoid damage in transit. Please retain the original box and packaging material. Under this warranty, Whynter will repair or replace any parts found defective. This warranty is not transferable. After the expiration of the warranty, the cost of labor and parts will be the responsibility of the original owner of the unit.

#### **THIS WARRANTY DOES NOT COVER:**

- Acts of God, such as fire, flood, hurricanes, earthquakes and tornadoes.
- Damage, accidental or otherwise, to the ice maker while in the possession of a consumer not caused by a defect in material or workmanship;
- Damage caused by consumer misuse, tampering, or failure to follow the care and special handling provisions in the instructions.
- Damage to the finish of the case, or other appearance parts caused by wear.
- Damage caused by repairs or alterations to the product by anyone other than authorized by the manufacturer.
- Freight and Insurance cost for the warranty service.

#### **DISCLAIMER OF IMPLIED WARRANTIES; LIMITATION OF REMEDIES**

CUSTOMER'S SOLE AND EXCLUSIVE REMEDY UNDER THIS LIMITED WARRANTY SHALL BE PRODUCT REPAIR OR REPLACEMENT AS PROVIDED HEREIN. CLAIMS BASED ON IMPLIED WARRANTIES, INCLUDING WARRANTIES OF MERCHANTABILITY OR FITNESS FOR A PARTICULAR PURPOSE, ARE LIMITED TO ONE YEAR OR THE SHORTEST PERIOD ALLOWED BY LAW, BUT NOT LESS THAN ONE YEAR. WHYNTER SHALL NOT BE LIABLE FOR CONSEQUENTIAL OR INCIDENTAL DAMAGES SUCH AS PROPERTY DAMAGE AND INCIDENTAL EXPENSES RESULTING FROM ANY BREACH OF THIS WRITTEN LIMITED WARRANTY OR ANY IMPLIED WARRANTY. SOME STATES AND PROVINCES DO NOT ALLOW THE EXCLUSION OR LIMITATION OF INCIDENTAL OR CONSEQUENTIAL DAMAGES, OR LIMITATIONS ON THE DURATION OF IMPLIED WARRANTIES, SO THESE LIMITATIONS OR EXCLUSIONS MAY NOT APPLY TO YOU. THIS WRITTEN WARRANTY GIVES YOU SPECIFIC LEGAL RIGHTS. YOU MAY ALSO HAVE OTHER RIGHTS THAT VARY FROM STATE TO STATE.

To obtain service or information, contact  
Whynter via email at [service@whynter.com](mailto:service@whynter.com) or call  
866-WHYNTER.

Product contents and specifications may change without notice.  
Copyright © 2013 Whynter LLC  
[www.Whynter.com](http://www.Whynter.com)