

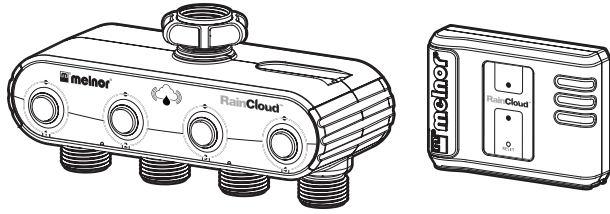

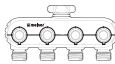

melnor[®] RainCloud[™] Smart Water Timer



Setup Guide

1 After opening the package, please ensure you have all parts.

-  × 1 Valve Unit
-  × 1 Control Unit
-  × 1 Power Adapter
-  × 1 Network Cable

If you discover that you are missing a part, please contact us:
844-MELNOR1 or raincloud@melnor.com

2 To begin, let's create your user account.

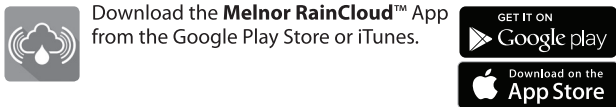

If you prefer, you can use the website, <https://raincloud.melnor.com>
Launch the app or go to the webpage and complete the registration:

- Select the **Register** tab.
- Select your preferred language.
- Enter your email address and select a password.
- Enter the CAPTCHA code.
- Click **Register**.

3 Once registered, you will need to log in to the server.

Please review and agree to the terms and conditions for the server.
You must agree to the terms and conditions to move forward.

You will automatically be taken to the **Manage** tab. On the next page you will have the opportunity to change your language selection.

Select the country in which you are located.



4 Now, let's connect the Control Unit.

Connect the power adapter to the control unit and plug it into a wall outlet. The LEDs on the control unit will begin flashing between the top and bottom.

Connect one end of the network cable to the Control Unit and the other end to an open port on your existing router.

Within 5 minutes, the LED flashing pattern will change, with the top LED blinking slowly in a constant pattern, and the bottom LED occasionally flashing. This indicates a successful connection to your home network.

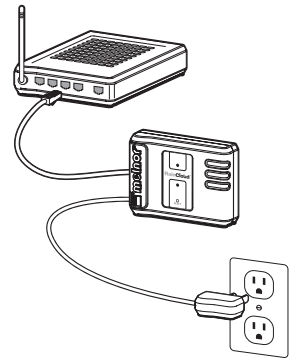

5 Return to the app or webpage.

Under the **Manage** tab, enter the 12-digit Control Unit identification from the back of the unit. It will be a mix of letters and numerals. The entry is not case sensitive.

Enter the Postal Code where the timer is located. This is needed to ensure you receive correct weather information.

Click **Register**.

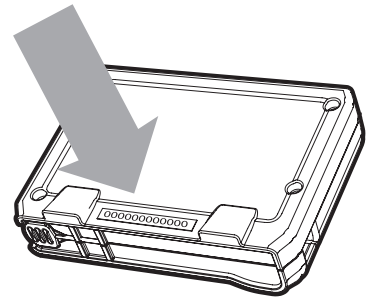

6 Now, for your Valve Unit.

Insert 4 fresh AA alkaline batteries in the back of the Valve Unit. Replace the battery cover and make certain it is secured.

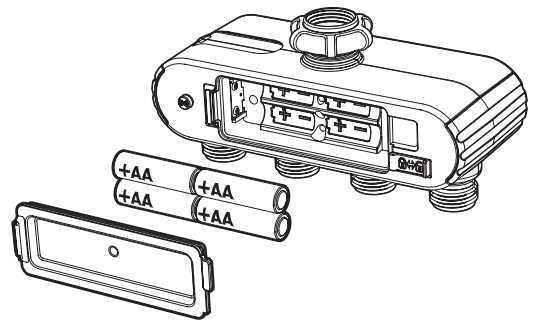

7 Finally, you need to register your Valve Unit.

On the **Manage** tab, go to "Register Valve Unit to Control Unit". The Control Unit should already be entered beside, "Assign To:".

Next to "Serial Number:" enter the 4-digit number from the bottom of your Valve Unit. The entry is not case sensitive.

Click **Register**.

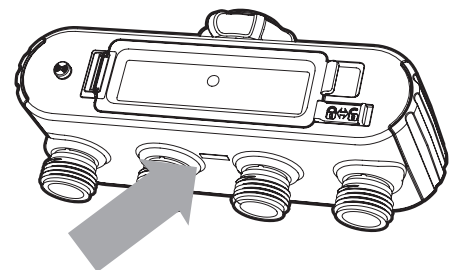

8 It's time to schedule your watering.

Select the **Home** tab. Make certain that both the Control Unit and Valve unit are Online.

Each valve (or zone) has its own schedule allowing complete flexibility. To schedule a Zone, click **Edit** in the **Auto** section.

Your watering schedule can be **Simple** or **Advanced**. Simple scheduling waters at regular intervals, i.e every 6 Hours, every 2 Days. Advanced scheduling allows selection of individual days and individual start times.

12 Next, enter how many times-per-day (or Cycles) you want to water. Now set the water options for each Cycle. First, enter the time you want to water beside "Start Water:" followed by the duration of the watering beside "Water For (min):"

If you select ECO Mode, The valve will open then close repeatedly during the course of the watering cycle. This allows the water to soak in while reducing any potential wasteful runoff. You can select how long you want the water on and off to optimize soaking and prevent excess water runoff.

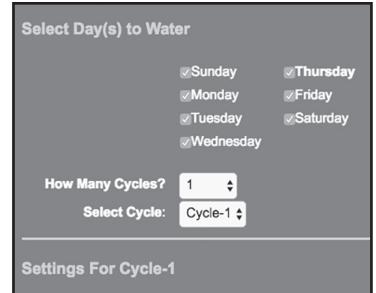

9 Simple Scheduling

With the Zone Editing Mode set to **Simple**, begin by entering the first watering time for the day beside "Start Water:". Then enter how long you would like to water each time beside "Water For (min)". Next, enter how often you would like to water next to "Water Every".

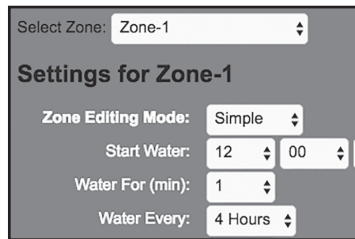

13 Make certain "Program is set to "ON" and then Save the schedule.

If you are scheduling more than 1 Cycle per day, select the next Cycle and repeat the scheduling process.

Be certain to Save the schedule each time.

Once the Schedule is saved and the Program is on, the Zone is ready to go. You can schedule additional Zones by selecting a new zone at the top of this page, or click **Home** to review the status of your Timer.

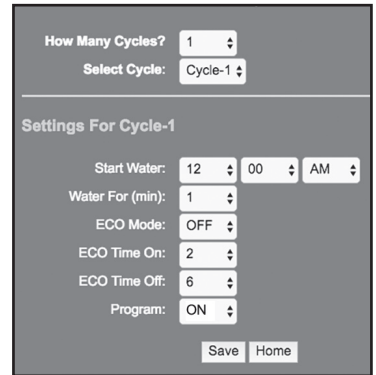

10 If you select "ECO Mode", the valve will open for 2 minutes, close for 6 minutes, and then repeat during the course of the watering cycle. This allows the water to soak in while reducing any potential wasteful runoff.

Make certain "Program" is set to "ON". Click **Save** and the water is scheduled. Once the Schedule is Saved and the Program is on, the Zone is ready to go. You can schedule additional Zones by selecting a new zone at the top of this page, or click **Home** to review the status of your Timer.

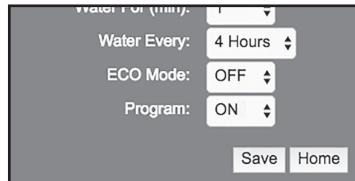

14 Rain Delay

If there is rain in the forecast, you can temporarily suspend a schedule to avoid watering when it is not needed. On the **Home** tab, simply select the number of days you would like to skip watering next to "Rain Delay". You need to set Rain Delay for each Zone. After the delay period, the schedule will begin running automatically.

For even more automation, add Melnor's unique AquaSentry™ Soil Moisture Sensor. AquaSentry will monitor the actual moisture in the soil to automatically maintain the proper level. For more information, visit www.melnor.com/aquasentry.

11 Advanced Scheduling

With the Zone Editing Mode set to **Advanced**, you have an increased number of options. First, you will notice you have the option of **Multiple Days**, **Even Days** or **Odd Days**. Even or Odd Days water on the corresponding calendar days. This is perfect for certain areas with watering restrictions.

The other option is Multiple Days. This allows you to select individual days of the week for watering. With Multiple Days selected, you can easily select or deselect days in the "Select Day(s) to Water" section.

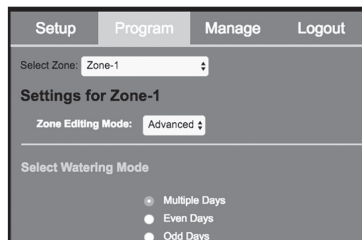

15 Manual Watering

So what happens if you just need to wash the car or do a little cleaning? There are two ways to start the water flow manually. First, using your smart device or the website, select the amount of time you want the water to flow for the desired valve. The valve will open for the selected time and then close automatically.

The maximum time the valve will open is 60 minutes. This is a precaution to prevent the valve being left open.

The second way to open a valve is to simply press the button on the front of the Valve Unit. The selected valve will open to let you complete your task. Once you are finished, press the button again to close the valve. There may be a slight delay between pressing the button and the valve opening or closing. Once again, the valve will automatically close after 60 minutes to prevent the valve being accidentally left open.