



ST8-WiFi Timer

Installation Guide and Operations Manual





ST8-WiFi Timer

Installation Guide and Operations Manual

Contents

Introduction

- Welcome to Rain Bird 1**
- Timer Features..... 1**
- Controls and Indicators..... 1**
 - Key Functions..... 1

Installation

- Tools and Supplies Needed..... 2**
- Mount Timer 2**
- Wiring Connections..... 3**
 - Connect Zone Valves..... 3
 - Valve Connections..... 3
 - Timer Connections..... 3
- Optional Accessories..... 4
 - Master Valve..... 4
 - Pump Start Relay..... 4
 - Rain Sensor 5
- Install Batteries 5**
- Connect Power..... 5**
 - Indoor Timer..... 5
 - Outdoor Timer 6

App Programming

- Activate Hotspot 7**
- Launch the Rain Bird App 7**

Programming at the Timer

- Date/Time 7**
- Zone Schedule 7**
 - Select Zone..... 8
 - Set Watering Run Times..... 8
 - Set Watering Start Times..... 8
 - Set Watering Start Days..... 8
 - Custom Days..... 9
 - Odd Days..... 9

- Even Days 9
- Cyclic Days 10

Options and Special Features

- Rain Delay..... 10**
- Copy Zone to Zone 10**

Normal Operation

- Auto 11**
- Off 11**

Additional Features

- Water Now 12**
 - Water ALL Zones:..... 12
 - Water ONE Zone:..... 12
- Seasonal Adjust..... 13**

Troubleshooting

- Error Detection..... 14**
- Connection Issues 14**
- Watering Issues 15**
- Electrical Issues 15**

Symbols

 **NOTE:** Alerts user to important operating functionality or installation instructions.

 **WARNING:** Alerts user to the presence of electricity which may pose a risk of shock or other hazard.

For help setting up or operating the ST8-WiFi Timer, please call Rain Bird toll-free Technical Support at:

1-800- RAIN BIRD (800-724-6247)
or visit www.rainbird.com

This Product Includes

Outdoor Timer

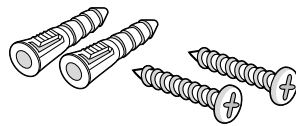

Mounting Screws and anchors (if needed)

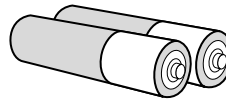

Batteries (2) AAA

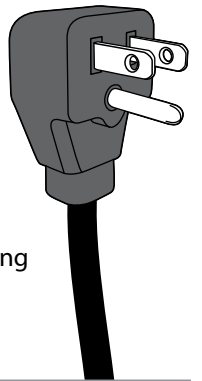

3-Prong plug

Indoor Timer

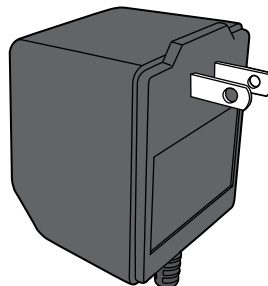

Transformer

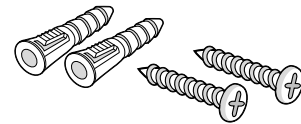

Mounting Screws and anchors (if needed)

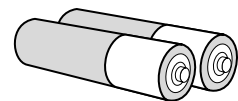

Batteries (2) AAA

Introduction

Welcome to Intelligent Watering!

Thank you for purchasing a WiFi-enabled Smart Timer from Rain Bird, a trusted name in irrigation throughout the world for over 80 years.

In this manual are step by step instructions for how to install and operate your timer.

Timer manual interface controls and indicators.

The manual timer interface allows for visual confirmation of schedule as well as custom programming when a mobile device is not available.

Key Functions

OFF

Cancel all active watering immediately and disable automatic irrigation.

AUTO

Watering occurs automatically according to programmed schedules.

Date/Time

Set the current Date and Time.

Display Screen

Displays programming information and irrigation status.

Seasonal Adjust

Increase or decrease watering duration (Run Times) for all Zones.

Next/Back Buttons

Select programming options.

Water Now

Start watering immediately for all Zones in sequence, or for any single Zone.

+ or - Buttons

Adjust program settings.

Watering Schedule

Create customized irrigation schedules to run automatically at specific times, durations and intervals.

Timer Features

The Timer has a variety of advanced water management features, including:

- Zone based programming allows independent irrigation scheduling for different areas (Zones), based on the specific water requirements for each area.
- Programs can be set to water on selected days of the week, odd or even calendar days, or at custom intervals, allowing enhanced flexibility and control of irrigation schedules.
- Multiple Watering Start Times allow you to run the same program multiple times on the same day.
- Seasonal Adjust allows quick adjustment of watering duration based on weather or other conditions.
- Manual Water feature to allow immediate watering of all Zones or one Zone at a time.

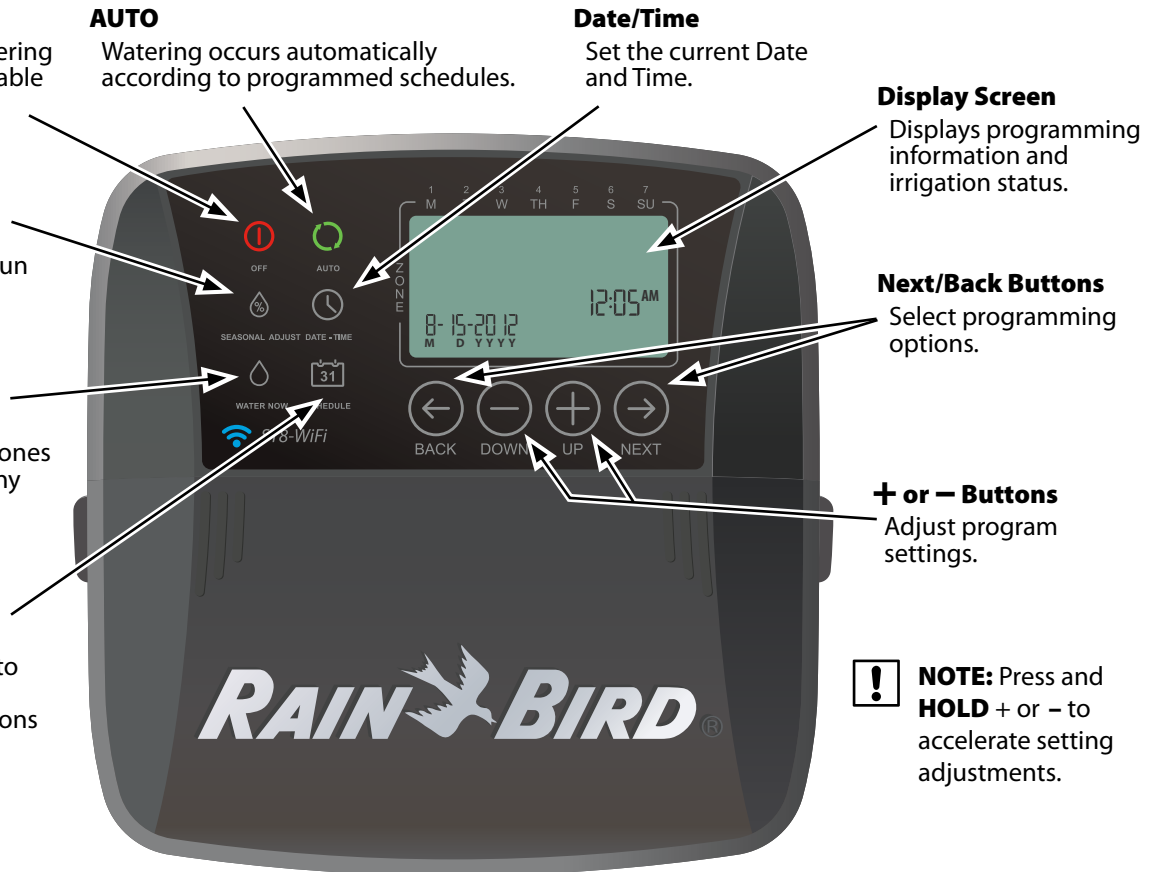

Installation

Tools and Supplies Needed

- **Phillips screwdriver**
- **Wire stripper**
- **Hammer**
- **Valve wire: direct burial, color coded multi-strand (not included)**
 - 18 gauge for runs less than 800 feet.
 - 14 gauge for runs greater than 800 feet.
- **Watertight splice connectors (not included)**

Before Removing Old Timer

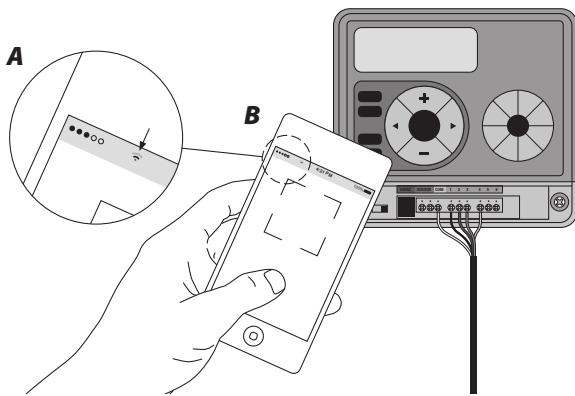

A. Check WiFi signal

With your phone, check WiFi signal strength of your timer's location (2 bars minimum is recommended). Boost signal if needed by adding a wireless router or moving the timer and router closer together.

B. Take A Photo of Wiring Details

This photo will be useful reference when installing the new timer.

Record Current Watering Times

Zone	Days Per Week	Duration
1	Mo, We, Fr	20 minutes

THEN UNPLUG TRANSFORMER/TURN OFF POWER AND REMOVE WIRES.

Mount Timer

Mount the Timer in an accessible location

- ! **NOTE:** Indoor models are for indoor use only. Outdoor models can be used indoors or outdoors.
- ! **NOTE:** For indoor models, choose a location within 6 feet of an AC power outlet and at least 15 feet away from major appliances or air conditioners.
- ▶ Drive a screw into the wall, leaving an 1/8" gap between the screw-head and the wall (use the supplied wall anchors if necessary).
- ▶ Locate the keyhole slot on back of the unit and hang it securely on the screw.
- ▶ Remove the wiring bay cover at the bottom of the unit and drive a second screw through the center hole at the bottom of the unit as shown (use the supplied wall anchors if necessary).

INDOOR MODEL

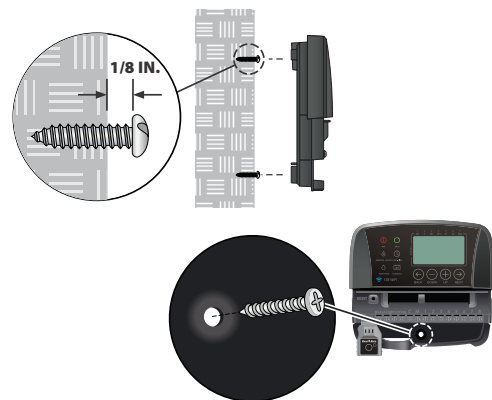

OUTDOOR MODEL

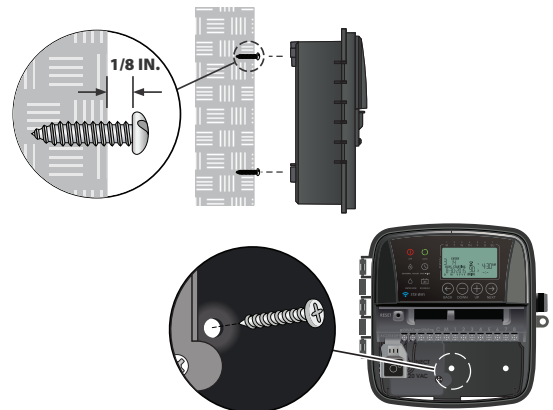

▲ If hard wiring for AC power, remove knockout for conduit

Wiring Connections

Connect the valve wires for each Zone.

NOTE: If installing an outdoor model, route all valve wires through conduit and through the knock-out on bottom of the unit.

Connect Zone Valves

Valve Connections

- ▶ Use direct burial cable to run wiring from the Timer to valves in the field.
- ▶ Connect a color coded wire from the direct burial cable to either wire on the valve.
- ▶ Connect the remaining wire on each valve to a "common" wire which then connects to the Timer.

NOTE: Use water-tight connectors for all wire splice connections. Depending on your landscape setup, you may need to run extension wires for the power and common connections.

Timer Connections

- ▶ Connect the color coded power wire from each external valve (or zone) to the corresponding zone number on the terminal block.

WARNING: To prevent damage to the Timer, connect only ONE valve to each open terminal.

- ▶ Connect the common wire to the common (C) terminal.

NOTE: Do not remove the yellow jumper wire on the terminals marked **SENS**.

- ▶ Check that all wiring connections are secure.
- ▶ Turn on external power (outdoor model) or plug in transformer (indoor model).

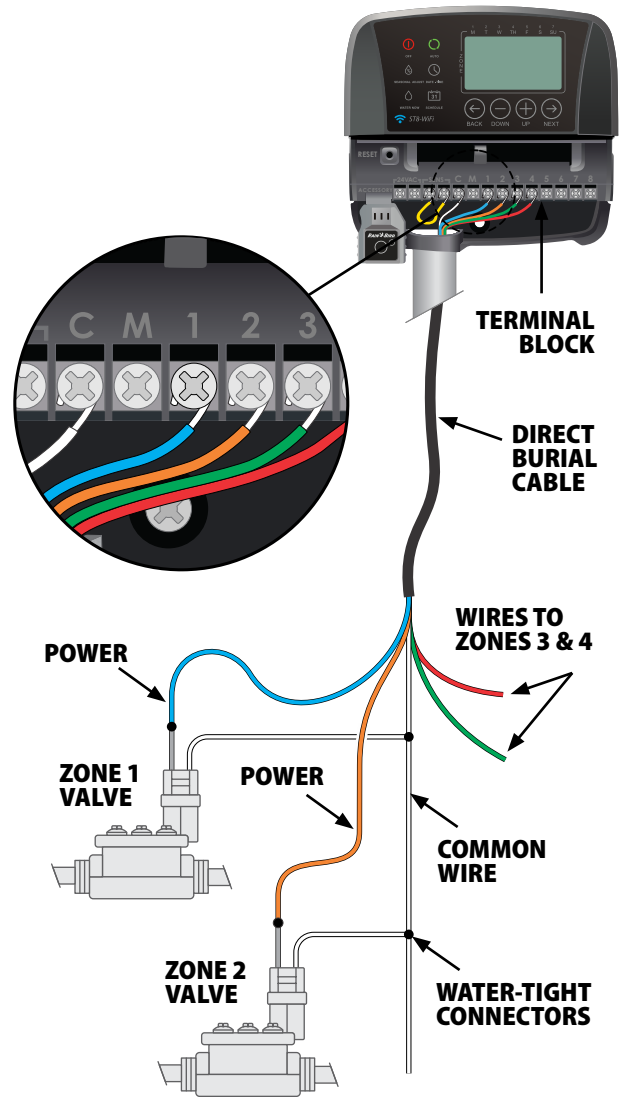

Optional Accessories

Connect an optional Master Valve, Pump Start Relay or Rain Sensor to the Timer.

Master Valve

Timers support the use of a master valve.

- ▶ Using a direct burial cable, connect one of the wires from the master valve (or pump start relay) to the master valve terminal (**M**).
- ▶ Connect the remaining wire from the master valve (or pump start relay) to the common terminal (**C**).

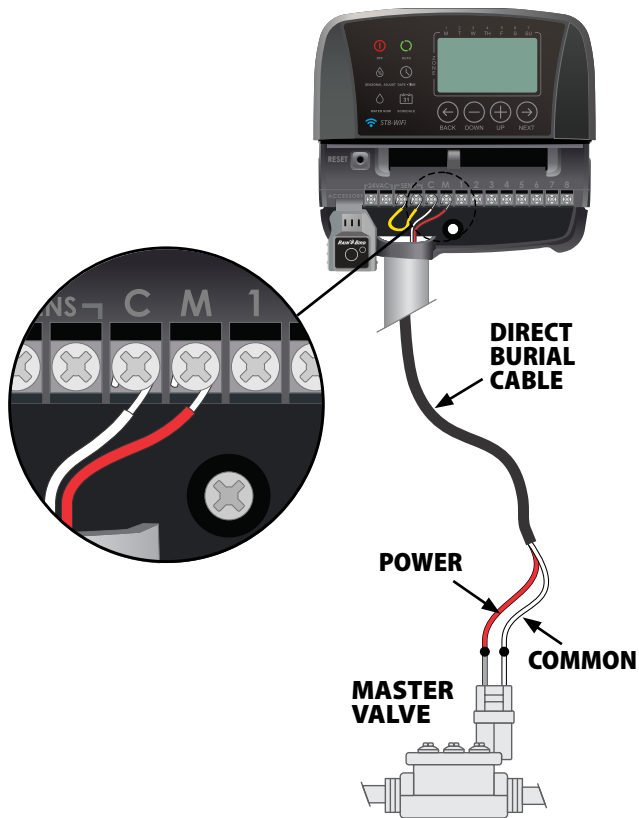

Pump Start Relay

Pumps are used in some places to draw water from a well or other source. If you are activating a pump from the Timer, you must install a pump start relay.

A pump start relay connects to the Timer in the same way as a Master Valve, but connects differently at the water source.

- ▶ To avoid possible pump damage, connect a short jumper wire from any unused zone terminal(s) to the nearest zone terminal in use.

Example: If a 4 zone model Timer is in use with only two zones connected, route the terminals for zones 3 and 4 to the nearest active terminal (in this example, zone 2).

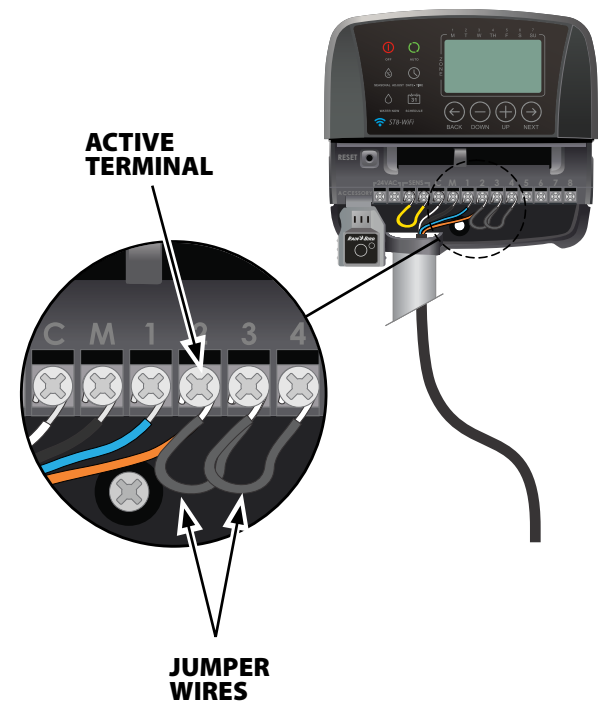

Rain Sensor

- ▶ Remove the wiring bay cover at the bottom of the unit.
- ▶ Remove the yellow jumper wire from the terminals marked SENS on the terminal block.

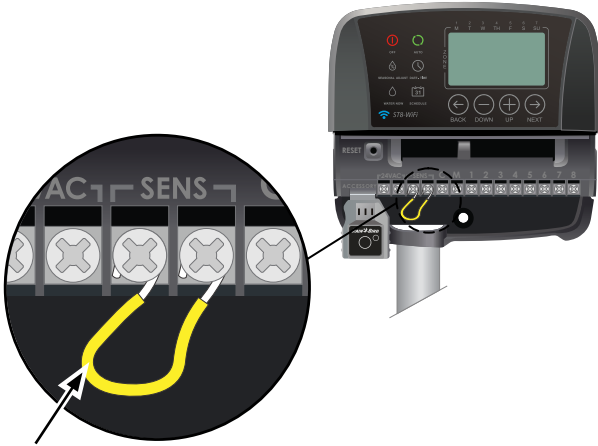

REMOVE JUMPER WIRE

! **NOTE:** Do not remove the jumper wire unless connecting a rain sensor. The Timer will not function if the jumper wire is removed and a rain sensor is not connected.

- ▶ Connect the two wires from the sensor to the SENS terminals.

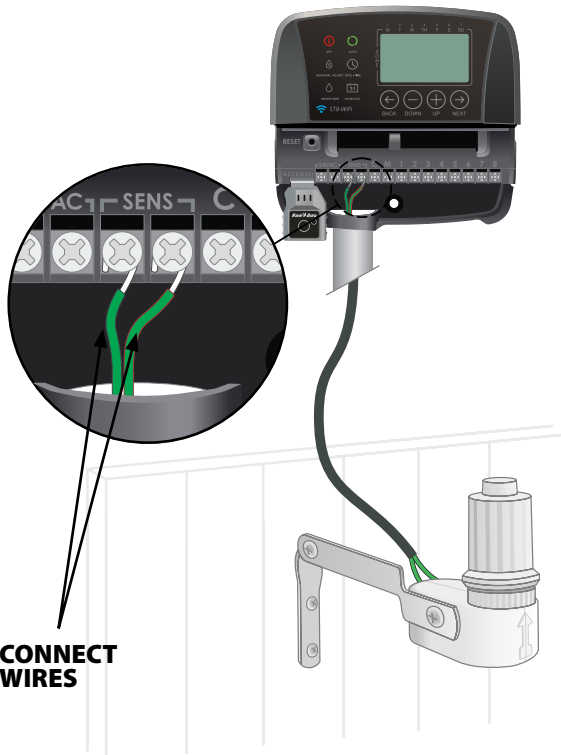

CONNECT WIRES

Install Batteries

The Timer can keep Date and Time if batteries are installed for backup.

! **NOTE:** Your programming is stored in Non-Volatile memory and will remain in the Timer even if batteries are not installed.

- ▶ Insert two AAA batteries into the battery slot above the terminal block, as shown below.

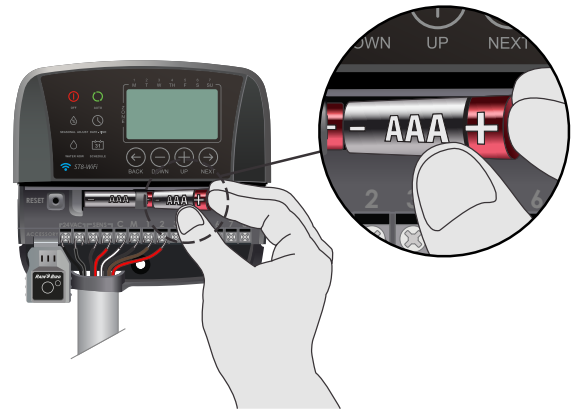

Connect Power

⚡ **WARNING:** DO NOT plug in or apply power to the Timer until you have completed and checked all wiring connections.

Indoor Timer

- ▶ Route the transformer power cord through the opening at the bottom of the unit.
- ▶ Connect the two end wires on the power cord to the two 24VAC terminal connections on the Timer.

⚡ **WARNING:** Do not attempt to link two or more Timers together using a single transformer.

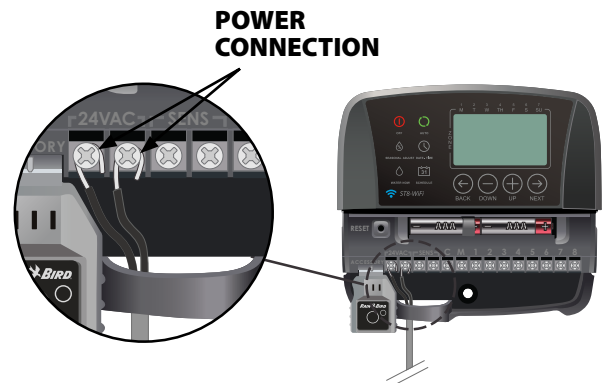



POWER CONNECTION

Outdoor Timer

The outdoor controller comes with a standard 6 ft power cord so it can be installed indoors, or outdoors if plugged into a weatherproof external outlet.

The outdoor controller can also be wired directly into a power supply by removing the power cord. It has an internal transformer that reduces supply voltage (120 VAC in US) to 24 VAC. You will need to connect power supply wires to the transformer's three wires. (Line, Neutral, Ground).

 **WARNING:** Electric shock can cause severe injury or death. Make sure power supply is turned OFF before connecting power wires.

 **WARNING:** All electrical connections and wiring runs must comply with local building codes.

 **WARNING:** DO NOT apply power to the unit until you have completed and checked all wiring connections.

 **WARNING:** Disconnect or shut off the external power source before connecting or disconnecting wires to the Timer.

- ▶ Remove the wiring bay cover at the bottom of the unit.
- ▶ Remove the WiFi Module to access the wiring compartment.
- ▶ Locate the wiring compartment in the lower left-hand corner of the unit and using a screwdriver, unscrew wiring compartment front cover.
- ▶ Unscrew the wire nuts connecting the power cord and the transformer wires. Remove the power cord wires from the transformer box.

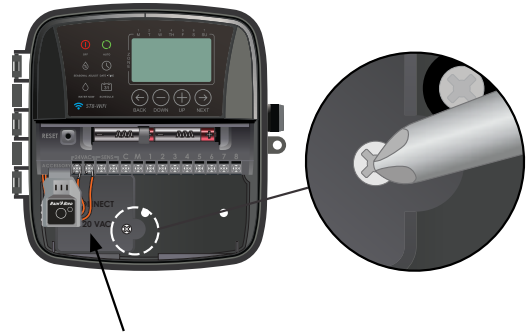

WIRING COMPARTMENT

- ▶ Route the three wires from an external power source into the wiring compartment.
- ▶ Using wire nuts, connect the external power wires to the internal connection wires inside the wiring compartment.

 **WARNING:** Be sure to connect the colored coded external wires to the same color internal connection wires, as follows:

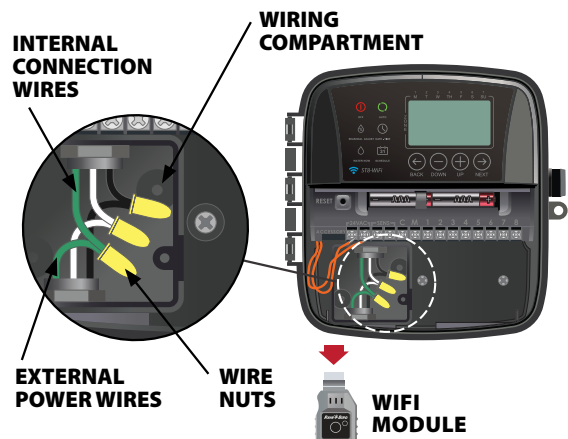

Power Wiring Connections

120 VAC (US)

Black supply wire (hot) to the black transformer wire

White supply wire (neutral) to the white transformer wire

Green supply wire (ground) to the green transformer wire

- ▶ Verify that all wiring connections are secure, then replace the wiring compartment cover.
- ▶ Reinstall the WiFi Module

App Programming

Search and download the Rain Bird App, available in both the Apple App Store for iPhone and Google Play store for Android.



Activate Hotspot

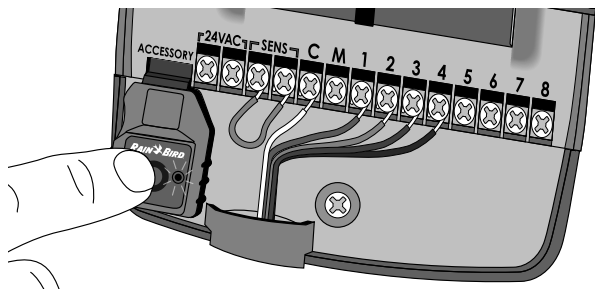

Verify WiFi Module is ready to connect

If the module is alternating blinking green and red, proceed to next step. If blinking red only, press button on the WiFi module to broadcast WiFi signal.

LIGHT FLASHES:	BROADCASTING WIFI
Red Only	NO
Alternating Red & Green	YES
Green Only	NO (connected to router)

3 Quick Green flashes can occur at two different times:

- ▶ When the WiFi module is first installed in the accessory port - this means the WiFi module communicated successfully with the timer
- ▶ When the App is connecting to a WiFi signal - this means there has been a successful connection.

Launch the Rain Bird App

Follow the App Setup Wizard to enter information about your yard and create an initial watering schedule.

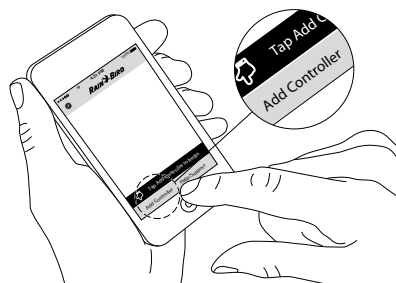

For additional information on programming the timer through the app, refer to videos found at wifi.rainbird.com.

Programming at the timer



Date-Time

Set the current calendar Date and Time of day.

- ▶ Press the **DATE-TIME** button.
- ▶ Press **+** or **-** to set the month (M); then press **NEXT**.
- ▶ Repeat above step to set the day (D) and year (YYYY).

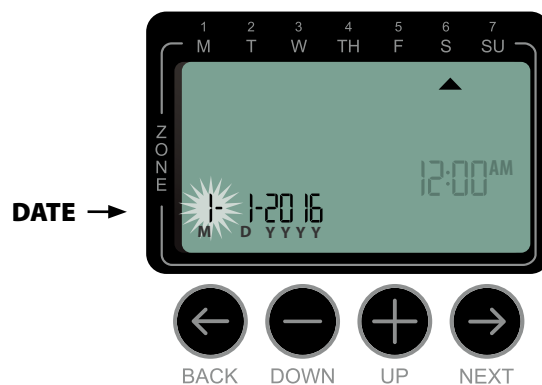

- ▶ Press **+** or **-** to set the hour (ensuring that AM/PM setting is correct); then press **NEXT**.

- ▶ Press **+** or **-** to set the minutes; then press **AUTO**.

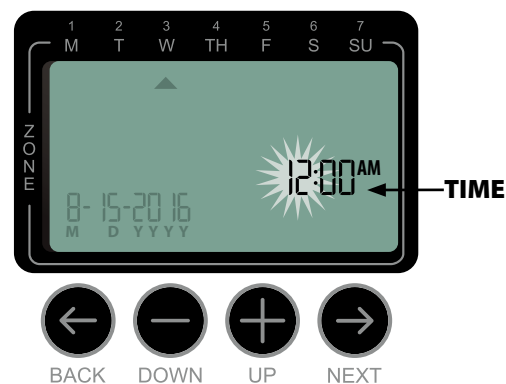

NOTE: Two AAA batteries can be installed to retain date and time in the event of a power outage. See "Install Batteries" for details.



Watering Schedule

Create customized irrigation schedules to run automatically at specific times, durations and intervals.

These schedules will stay in sync with the schedules created in the app. If changes are made in the timer, they will be updated to the app the next time it is opened. Once changes are made in the app and saved, they will be shown at the timer screen.

Press the **SCHEDULE** button.

1 Select Zone

Zones are designated areas (for example, "Rose Garden") that you define as locations for watering.

Press **+** or **-** to select the desired Zone Number; then press **NEXT**.

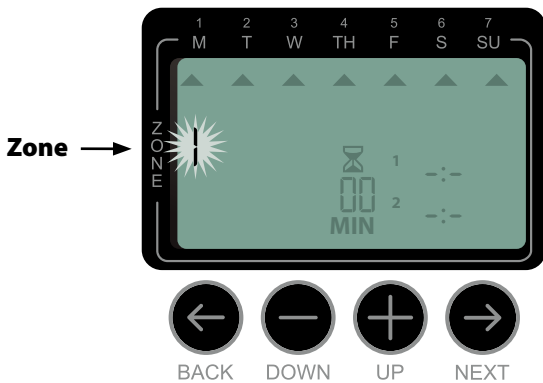

2 Set Watering Run Times

Watering Run Times are durations (for example, 20 minutes) set for watering.

NOTE: Run Times can be set between 1 to 199 minutes.

Press **+** or **-** to set the desired Run Time (MIN); then press **NEXT**.

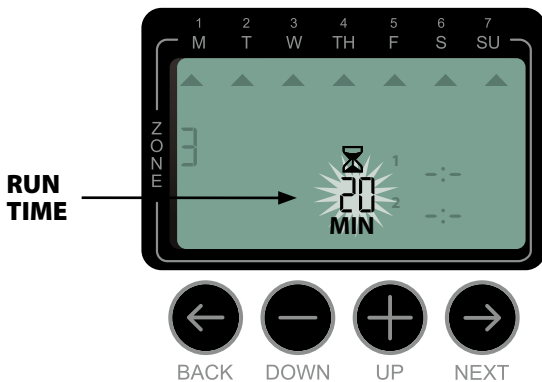

3 Set Watering Start Times

Watering Start Times are times of day at which watering is set to begin.

NOTE: A total of up to six Start Times (1-6) are available for each Zone.

Press **+** or **-** to set the 1st Start Time (ensuring that AM/PM setting is correct); then press **NEXT**.

NOTE: Start Time adjustments are set in 10 minute increments.

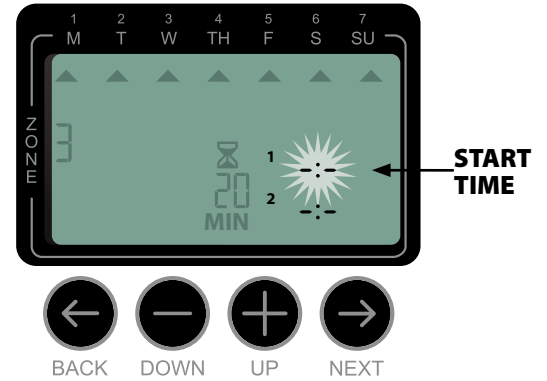

REPEAT as desired to set additional Start Times for that Zone.

NOTE: Pressing **NEXT** when **-:-** (OFF) is blinking on the display will advance to Step 4.

NOTE: If multiple zones have the same or overlapping watering times, the Timer will water the zones in sequence (multiple zones will not run at the same time).

4 Set Watering Start Days

Watering Start Days are the calendar days or intervals (for example, Monday, Wednesday and Friday) on which watering is allowed.

Press **+** or **-** to select one of four available Watering Start Day options:

- a. **Custom Days** - To schedule watering to occur on selected days of the week, **go to 4a.**
- b. **Odd Days** - To schedule watering to occur on all odd calendar days (1,3,5...29 etc.), **go to 4b.**
- c. **Even Days** - To schedule watering to occur on all even calendar days (2,4,6...30 etc.), **go to 4c.**
- d. **Cyclic Days** - To schedule watering to occur at intervals (every 2 days, or 3 days, etc.), **go to 4d.**

4a Custom Days

Press **+** or **-** to select  then press **NEXT**.

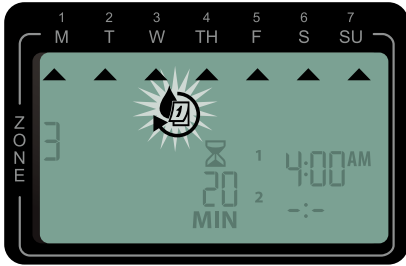

Press **+** (to enable) or **-** (to disable) the blinking Selection Day. Cursor will then advance to the next Selection Day.

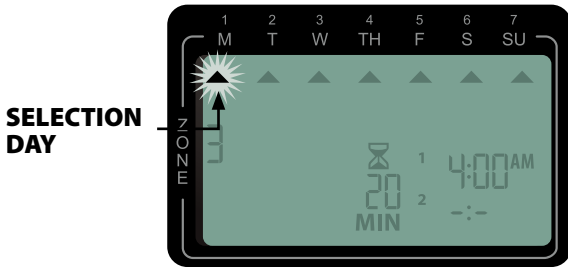



Press **+** or **-** to set each subsequent day of the week as desired.

 **REPEAT** Steps 1-4 for remaining zones.

4b Odd Days

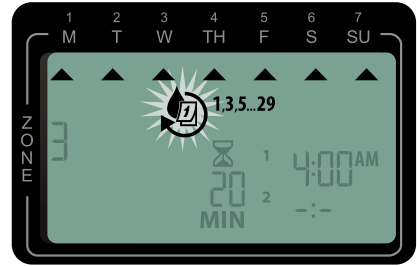
Press **+** or **-** to select  1,3,5...29 then press **NEXT**.



 **REPEAT** Steps 1-4 for remaining zones.

4c Even Days

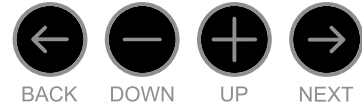
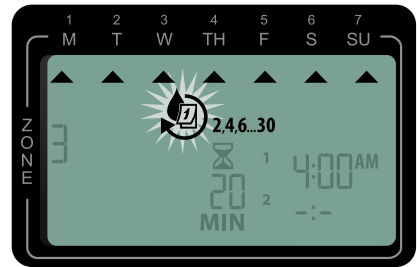

Press **+** or **-** to select  2,4,6...30 then press **NEXT**.

 **REPEAT** Steps 1-4 for remaining zones.

4d Cyclic Days

Press **+** or **-** to select Cyclic Days; then press **NEXT**.

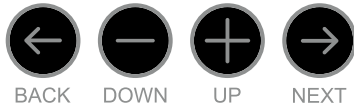

NOTE: If any settings for Day Cycle or Start Date have already been entered for previous zones, those values will be shown on the display.

Press **+** or **-** button to set the desired Day Cycle; then press **NEXT**.



DAY CYCLE

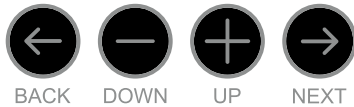

Press **+** or **-** to set desired Start Date; then press **NEXT**.



START DATE

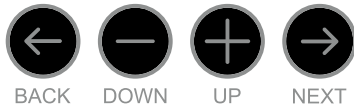

NOTE: The Start Date should be the first day the zone is to be watered. Only Start Dates that fall within the selected Day Cycle are available.

REPEAT Steps 1-4 for remaining zones.

Options and Special Features

Rain Delay

Watering schedules can be delayed manually for up to 14 days due to rain or other needs. While rain delay is enabled no scheduled watering will take place for any zones. The **WATER NOW** feature can still be used. After the immediate watering is complete from a **WATER NOW** session the rain delay feature will resume for the programmed number of days.

During normal operation, **AUTO** has been pressed,

- ▶ Press and hold the **+** button
- ▶ The number 01 will appear on the screen along with the stop icon.
- ▶ This means the rain delay has been enabled for 1 day.

To increase or decrease the rain delay press **+** or **-**

- ▶ To turn off the rain delay press **-** until the days of rain delay turns to 0
- ▶ After the rain delay days are completed the watering schedule will resume.

Copy Zone to Zone

Scheduling information can be copied from one zone to another zone to speed up programming.

Press the **SCHEDULE** button.

Press **+** or **-** to select the **SUBSEQUENT** Zone number.

Press and hold **BACK**, then press and release the **SCHEDULE** button.

Normal Operation



Auto

Watering occurs automatically according to programmed irrigation schedules.

Press the **AUTO** button to resume normal operation whenever programming is completed and to monitor active watering.

NOTE: Unless the **OFF** button is pressed, the Timer will revert to AUTO mode after 10 minutes if no programming activity (button presses) occurs during that time.

In Auto Mode:

The display shows the current time, date and day of the week:



During Watering:

The display shows a blinking sprinkler symbol, the active Zone number and watering Run Time remaining for that Zone.

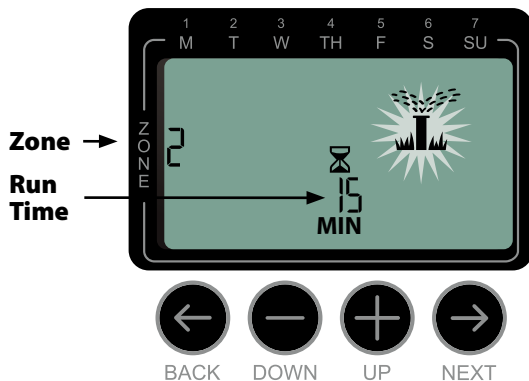

Press **+** or **-** to adjust watering Run Time remaining for the active Zone as desired.

Press **NEXT** to cancel watering for the active Zone and advance to the next Zone in the irrigation cycle.



NOTE: The next Zone will start watering immediately if Start Times are stacked. Otherwise, the next Zone will start according to the programmed schedule.



Off

Cancel all active watering immediately and disable automatic irrigation.

Press the **OFF** button to immediately cancel all active watering.

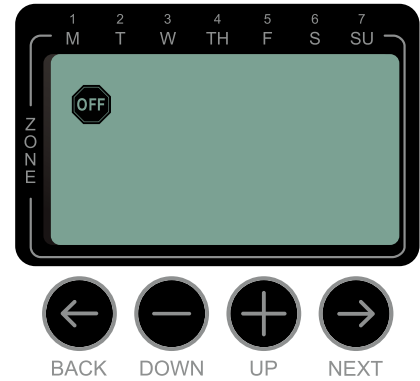

Programmed irrigation schedules remain stored in memory even when the Timer is turned off or if power is lost.



NOTE: Press the **AUTO** button to resume normal operation. Automatic irrigation will NOT occur if the Timer remains in OFF mode.

Additional Features



Water Now

Start watering immediately for **ALL Zones** or for **any ONE Zone**.

Water ALL Zones:

- Press the **MANUAL WATERING** button.
- ALL Zones** appears as the default selection; press **NEXT** to continue.

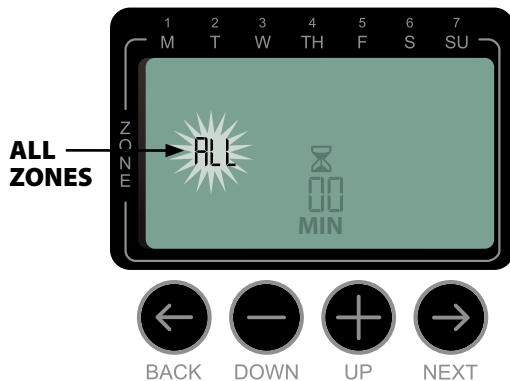

- Press **+ or -** to set the desired Run Time; then press **NEXT** to begin watering.

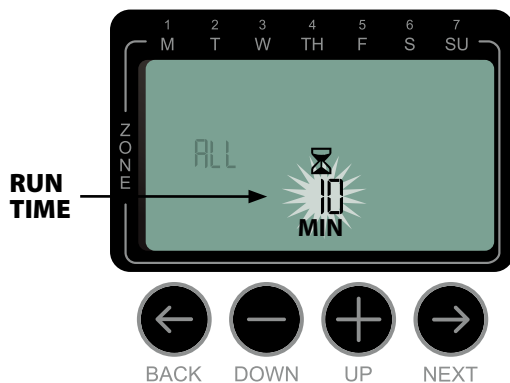

During Manual Watering:

- Press **+ or -** to adjust watering Run Time remaining for the active Zone as desired.
- Press **NEXT** to cancel watering for the active Zone and advance to the next Zone in the cycle.
- Press **OFF** to stop the remaining Manual Watering cycle; then press **AUTO** to resume normal operation.

Water ONE Zone:

- Press the **MANUAL WATERING** button.
- Press **+ or -** to select any **ONE Zone**; then press **NEXT**.

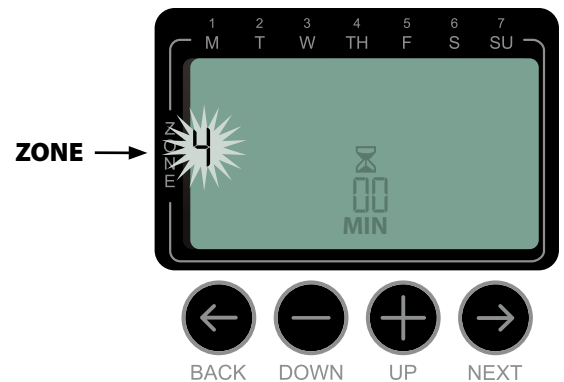

- Press **+ or -** to set the desired Run Time; then press **NEXT** to begin watering.

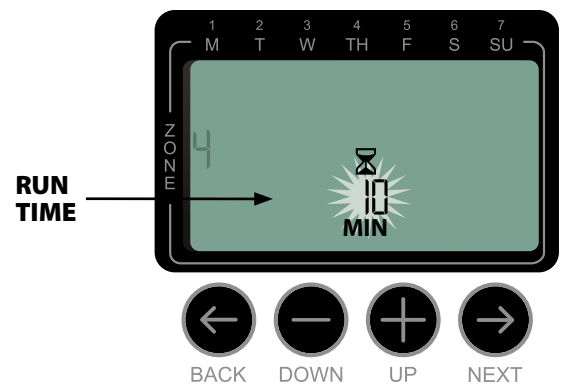

During Manual Watering:

- Press **+ or -** to adjust watering Run Time remaining for the active Zone as desired (reducing to 0 minutes will stop Manual Watering).
- Press **NEXT** or **OFF** to stop the remaining Manual Watering cycle (if **OFF** is pressed, then press **AUTO** to resume normal operation).





Seasonal Adjust

Increase or decrease watering duration (Run Times) for all Zones.

 Press the **SEASONAL ADJUST** button.

 Press **+** or **-** to increase or decrease the SEASONAL ADJUST percentage setting.

 **NOTE:** The SEASONAL ADJUST value can be adjusted from -90% to +100%. For example, a +50% adjustment means a Run Time of 10 minutes will become 15 minutes.

 **NOTE:** If “Use Weather Correction Data” is enabled in the app, then adjusting the seasonal adjust at the timer will only make a change for the day. The adjustment will change back to the seasonal adjust setting controlled by the app the next day.

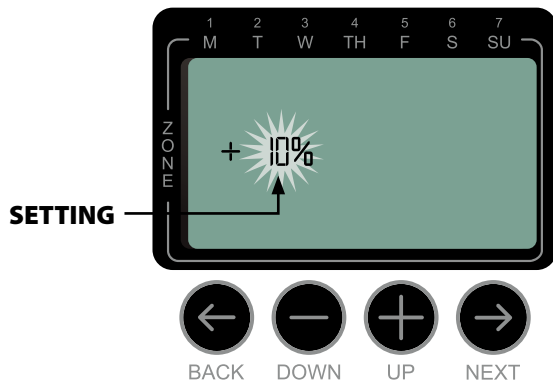

 **NOTE:** SEASONAL ADJUST applies to ALL programmed irrigation schedules.

 Press **AUTO** to resume normal operation.

Troubleshooting

Error Detection

The Timer has a built-in error detection that senses an electrical short circuit or overload condition on a Zone’s output line.

In the event of an error condition, the following steps take place regarding the error:

- The affected Zone number and “Err” alert message will show on the display when the unit is in either AUTO or MANUAL WATERING mode.
- All irrigation for the affected Zone is cancelled and watering advances to the next operable Zone in the irrigation queue.

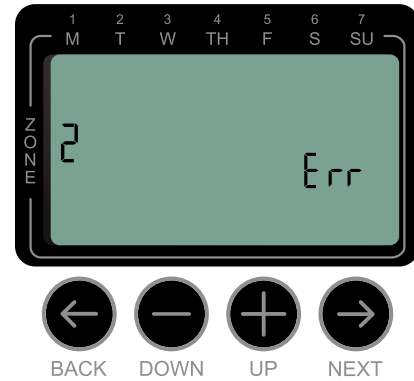

! **NOTE:** The Timer will attempt to water the affected Zone again at the next scheduled watering. Completion of a successful watering will clear the error condition associated with that Zone.

Connection Issues

Problem	Possible Cause	Possible Solution
Connection issues between mobile device and timer.	WiFi signal strength is low.	Verify with your phone the WiFi signal is at least 2 bars of strength at the location of the timer. If it is not try to relocate the WiFi router so it is closer and does not have as much interference. If this is not possible use a WiFi range extender to boost the signal strength.
	Timer is not connected to mobile device and WiFi module is blinking green.	The mobile device needs to be re-connected to the controller, or connected for the first time. Follow App Programming instructions on page 7.
	Timer is not connected to mobile device and WiFi module is blinking alternating red and green.	Verify the mobile device is connected to the Rain Bird WiFi signal. This can be done in the WiFi settings of the mobile device. Once the WiFi signal is connected, the app should be able to communicate with the timer.
	Timer is not connected to mobile device and WiFi module is blinking red.	Press the WiFi module button and wait for the LED to start blinking alternating red and green. Launch the setup wizard by pressing the Add Controller button in the app and follow the easy step by step instructions. If there is a timer card in the app that is no longer being used it can be deleted by pressing the trashcan button at the bottom of the card.
	Timer is not connected to mobile device and WiFi module is not blinking.	Check to make sure the timer is plugged into an outlet, and the outlet is providing power. If the timer is powered, make sure the WiFi module is seated correctly in the accessory port. If needed, pull it out and plug it back in.

Watering Issues

Problem	Possible Cause	Possible Solution
Programmed schedules and manual watering functions do not start.	Water source not supplying water.	Verify there is no disruption to the main water line and that all other water supply lines are open and functioning properly.
	Wiring is loose or not properly connected.	Check that valve wiring and master valve or pump start relay wiring is securely connected at the Timer and in the field.
	Valve wires are corroded or damaged.	Check valve wiring for damage and replace if necessary. Check wiring connections and replace with watertight splice connectors if needed.
	Connected rain sensor may be activated.	Let the rain sensor dry out or else disconnect it from the Timer terminal block and replace it with a jumper wire connecting the two SENS terminals.
	Jumper wire connecting the two SENS terminals on the terminal block may be missing or damaged.	Jumper the two SENS terminals on the Timer terminal block by connecting them with a short length of 14 to 18 gauge wire.

Electrical Issues

Problem	Possible Cause	Possible Solution
Display is blank.	Power not reaching the Timer.	Verify the main AC power supply is securely plugged in or connected and working properly.
		Verify the power supply wires are connected to the Timer "24 VAC" terminals. (Indoor model.)
Display is frozen and Timer will not accept programming.	An electrical surge may have interfered with the Timer's electronics.	Unplug the Timer for 2 minutes, then plug it back in. If there is no permanent damage, the Timer should accept programming and resume normal operation.
		Press and release the RESET button.



Rain Bird Corporation
6991 East Southpoint Road
Tucson, AZ 85756
Phone: (520) 741-6100
Fax: (520) 741-6522

www.rainbird.com

®Registered trademark of the Rain Bird Corporation
©2016 Rain Bird Corporation

182188-01 Rev.03/16

To comply with FCC and Industry Canada RF exposure limits for general population / uncontrolled exposure, the antenna(s) used for this transmitter must be installed to provide a separation distance of at least 35mm from all persons and operating in conjunction with any other antenna or transmitter.

This device complies with Part 15 of the FCC Rules and Industry Canada License-exempt RSS standards. Operation is subject to the following two conditions:

1. This device may not cause harmful interference, and
2. This device must accept any interference received, including interference that may cause undesired operation.

Changes or modifications not expressly approved by the party responsible for compliance could void the user's authority to operate the equipment.