

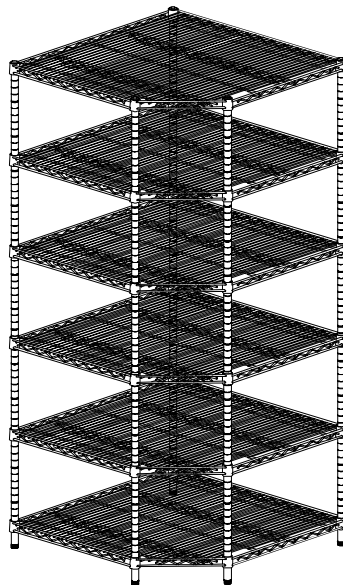

Item #1000 000000
Model #HD24CRCPS

USE AND CARE GUIDE

6-SHELF CORNER STORAGE RACK



Questions, problems, missing parts? Before returning to the store,
call Customer Service
8 a.m. - 6 p.m., EST, Monday-Thursday

8 a.m. - 5 p.m., EST, Friday

888-449-5520

HOMEDEPOT.COM

THANK YOU

We appreciate the trust and confidence you have placed in HDX through the purchase of this storage unit. We strive to continually create quality products designed to enhance your home. Visit us online to see our full line of products available for your home improvement needs. Thank you for choosing HDX!

Table of Contents

Table of Contents	2	Specifications	2
Safety Information.....	2	Package Contents.....	3
Warranty.....	2	Assembly	4
Pre-Assembly	2		
Planning Assembly.....	2		

Safety Information

 **WARNING:** Do not exceed the maximum weight limit of 800 lbs. per shelf, evenly distributed.

 **CAUTION:** Do not allow children to climb or play in or around the shelves.

 **CAUTION:** Evenly distribute the weight across each shelf, and keep the heavier loads on the bottom.

 **CAUTION:** Place the unit on a level surface to avoid a tipping hazard.

Warranty

If this product is defective, contact the customer service team at 888-449-5520 or visit www.HomeDepot.com.

Pre-Assembly

PLANNING ASSEMBLY

Carefully read all instructions and caution warnings before beginning assembly. Determine shelving heights prior to assembly to avoid dismantling for adjustment. More than one person may be required during assembly. Use care when handling. Assemble the unit on a soft surface, such as carpet, to avoid scratching the floor or the unit.

 **CAUTION:** Place the unit on a level surface to avoid a tipping hazard.

 **NOTE:** Please dispose of the loose, round plastic pieces. These are used to separate the shelves for shipping purposes.

SPECIFICATIONS

Weight	86.15 lbs.
Width	32.75 in.
Depth	32.75 in.
Height	72 in.

Pre-Assembly (continued)

PACKAGE CONTENTS

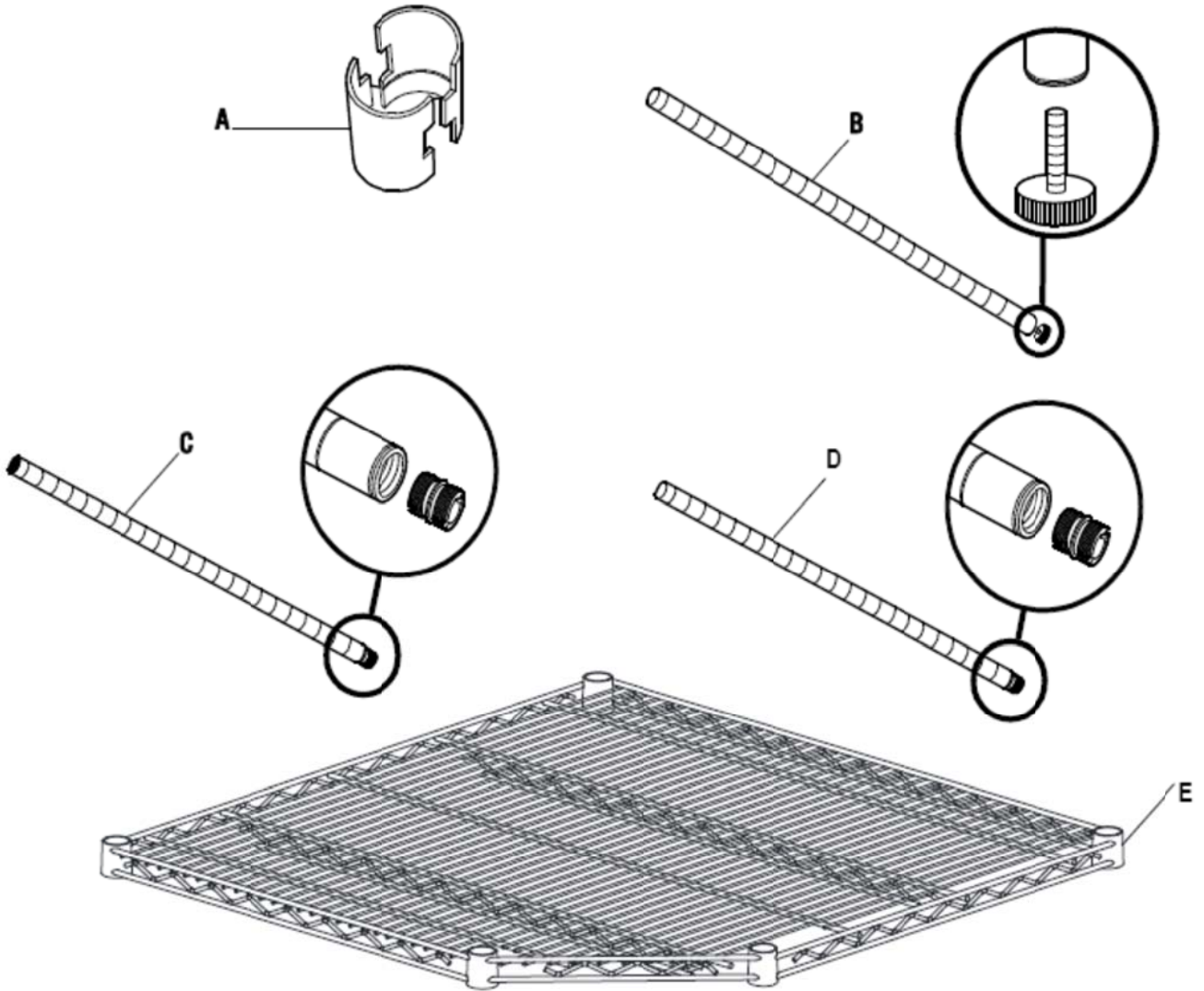

Part	Description	Quantity
A	Plastic Sleeve	62 (2 spare parts)
B	Bottom Post Assembly	5
C	Top Post Assembly	5
D	Middle Post Assembly	5
E	Shelf	6

Assembly

1 Assembling the posts

- Screw the top post assembly (C) middle post assembly (D) and bottom post assembly (B) together until secure.
- Repeat this procedure for the remaining posts (B, C and D).

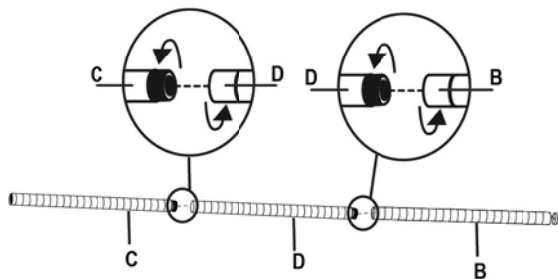

2 Attaching the bottom shelf



NOTE: More than one person may be required for this step.

- Locate the desired position where the lowest shelf will be installed onto the post assemblies.
- Insert a plastic sleeve (A) into the appropriate groove on each bottom post assembly (B). Ensure the tapered end of the plastic sleeve (A) is facing up towards the top post (C).
- Place the shelf (E) on its side, and slide the post assemblies up through the bottom of the shelf (E), beginning with the top post (C), until the shelf (E) is firmly seated on the plastic sleeves (A).
- After the shelf (E) is in place, turn the unit to the upright position.
- Push down on each corner of the shelf (E), ensuring it is in the fully locked position.

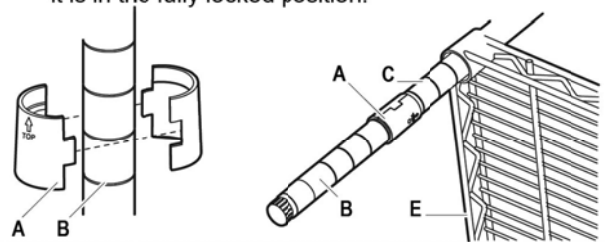

3 Attaching additional shelves

- Locate the desired position of the next lowest shelf (E), and insert the plastic sleeves (A) into the appropriate grooves on the post assemblies.
- Slide the shelf (E) down from the top of the post assemblies and onto the plastic sleeves (A). Push down on each shelf (E) corner, ensuring that it is firmly seated on the plastic sleeves (A).
- Repeat this procedure for the remaining shelves (E).

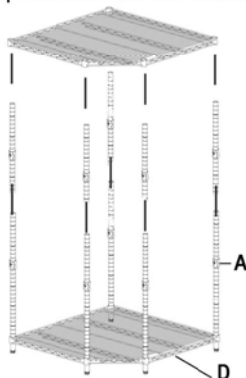

4 Leveling the unit



NOTE: The bottom post assemblies (B) have foot levelers pre-installed into the bottoms.

- Screw the pre-installed foot levelers clockwise or counterclockwise until the unit is level.

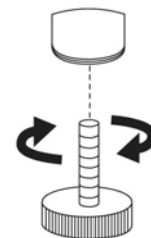



Questions, problems, missing parts? Before returning to the store,
call Customer Service

8 a.m. - 6 p.m., EST, Monday-Thursday

8 a.m. - 5 p.m., EST, Friday

888-449-5520

HOMEDEPOT.COM

Retain this manual for future use.