

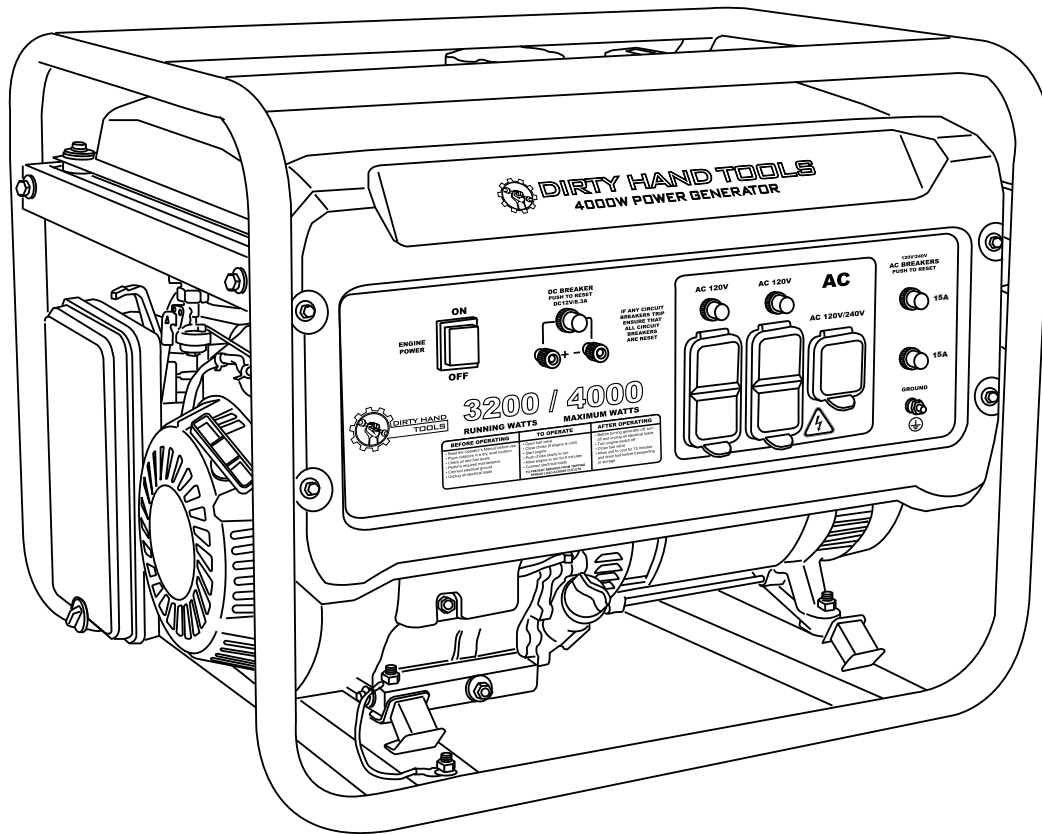

**DIRTY HAND
TOOLS**

3200 RATED WATTS/4000 MAXIMUM WATTS PORTABLE POWER GENERATOR



MODEL # 101091

Operation Manual



This safety alert symbol identifies important safety messages in this manual. Failure to follow this important safety information may result in serious injury or death.

Part # 101372 Rev C



For Service or Questions

Call 1-877-487-8275

720-287-5182

www.dirtyhandtools.com

Dirty Hand Tools® is a brand of



1100 W 120th Ave, Suite 600
Westminster, CO 80234 • 720-287-5182

Table of Contents

Important Safety Information	4
Unpacking and Setup	7
Filling with Gasoline and Oil.....	8
Operation Precautions	9
Calculating Wattage	11
Operation	12
Maintenance.....	14
Troubleshooting	17
Storage	19
Warranty and Specifications.....	Back Cover

Important Safety Information



WARNING

WARNING: Read and thoroughly understand all instructions and safety information before operating this portable power generator. Failure to do so may cause serious injury or death. Do not allow anyone to operate this portable power generator who has not read this manual. As with all power equipment, a portable power generator can be dangerous if used improperly. Do not operate this portable power generator if you have doubts or questions concerning safe operation.



Call our customer service department at **720-287-5182**, **1-877-487-8275**, or visit www.dirtyhandtools.com if you have any questions or concerns about the safe operation of this equipment.



DANGER

Intended Use

Do Not Use the portable power generator for any purpose other than for which it was designed. Any other use is unauthorized and may result in serious injury or death.

Personal Protective Equipment

Wear ANSI-approved safety goggles and heavy-duty work gloves during set up. While this portable power generator operates at a relatively low noise level, about 70dB, you may want to wear ear plugs or noise deafening headphones.



CAUTION

People with pacemakers should consult their physician(s) before use. Electromagnetic fields in close proximity to a heart pacemaker could cause pacemaker interference or pacemaker failure. Caution is necessary when near the engine's magneto or recoil starter.



CALIFORNIA PROPOSITION 65 WARNING

Engine exhaust, some of its constituents and certain product components contain or emit chemicals known to the state of California to cause cancer and birth defects or other reproductive harm.

Important Safety Information

General Safety

Failure to follow warnings, cautions, assembly and operation instructions in the Operation Manual may result in serious injury or death.



DANGER

READ THE OPERATION MANUAL BEFORE OPERATION.

- **Do not** permit children to operate this equipment at any time. Do not permit others that have not read and understood the complete Operation Manual to operate this equipment.
- **Do not** operate the portable power generator when under the influence of alcohol, drugs or medication.
- **Do not** allow a person who is tired or otherwise impaired or not completely alert to operate the portable power generator.



DANGER

NEVER place fingers, hands, or body near the generator when it is running. Do not lean or reach over the generator.

- Keep all safety guards in place and in proper working order.
- Keep all people (except the operator) a minimum of six feet from the generator during operation.
- Do not transport the generator with the engine running.
- Do not tilt the machine while the engine is running.
- Do not leave the generator unattended when it is running. Turn off the engine before leaving the area.
- Never run the engine in an enclosed area or without proper ventilation as the exhaust from the engine contains carbon monoxide, which is an odorless, tasteless, and deadly poisonous.
- Fill the gasoline tank outdoors with the engine off and allow the engine to cool completely.
- Do not operate the engine with the air cleaner or cover over the carburetor air-intake removed, except for adjustment. Removal of such parts could create a fire hazard.
- The muffler and engine become very hot with use and can cause a severe burn; do not touch. Allow the engine to cool before refueling, doing maintenance, or making adjustments.

Important Safety Information

Safety Decals

Safety labels on the portable power generator are to remind you of important information while you are operating the unit. Make sure all safety warning decals are attached and in readable condition. Replace missing or defaced decals. Contact Dirty Hand Tools at 1-877-487-8275 for replacement decals.

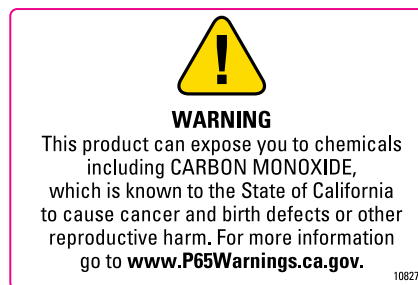
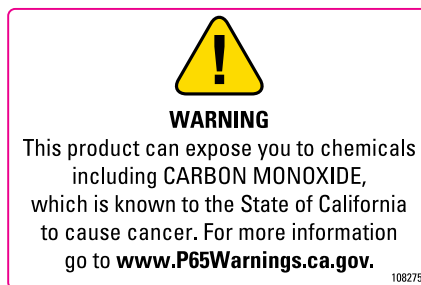
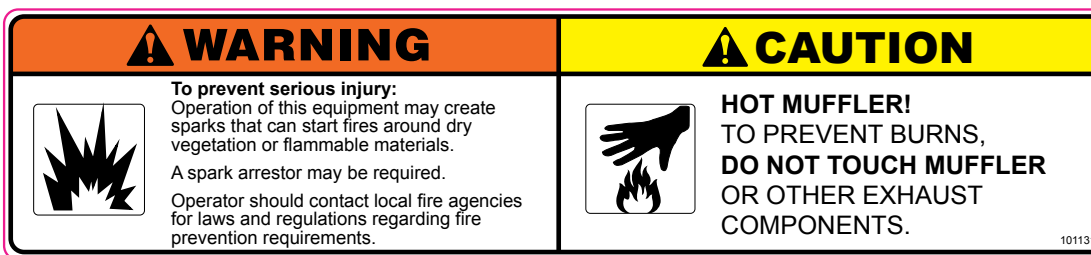
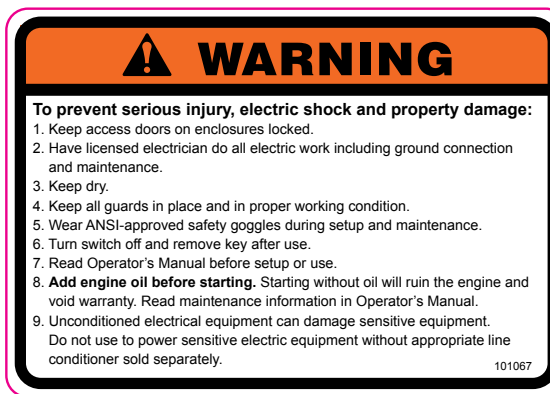
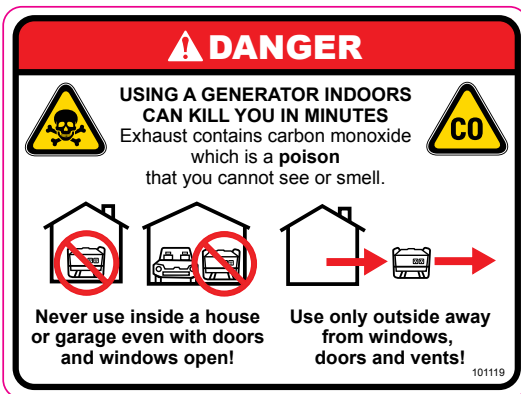
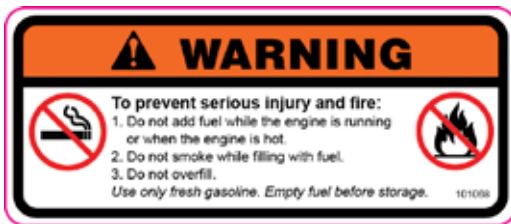

Unpacking and Setup

Your portable power generator is completely assembled at the factory. Save the packing materials and box for future use as a storage container. Setup for use outside in a well ventilated area on a level, stable surface away from doors, windows, vents, etc.

COMPLETELY READ AND UNDERSTAND THE OPERATOR'S MANUAL BEFORE ATTEMPTING TO OPERATE THE GENERATOR.

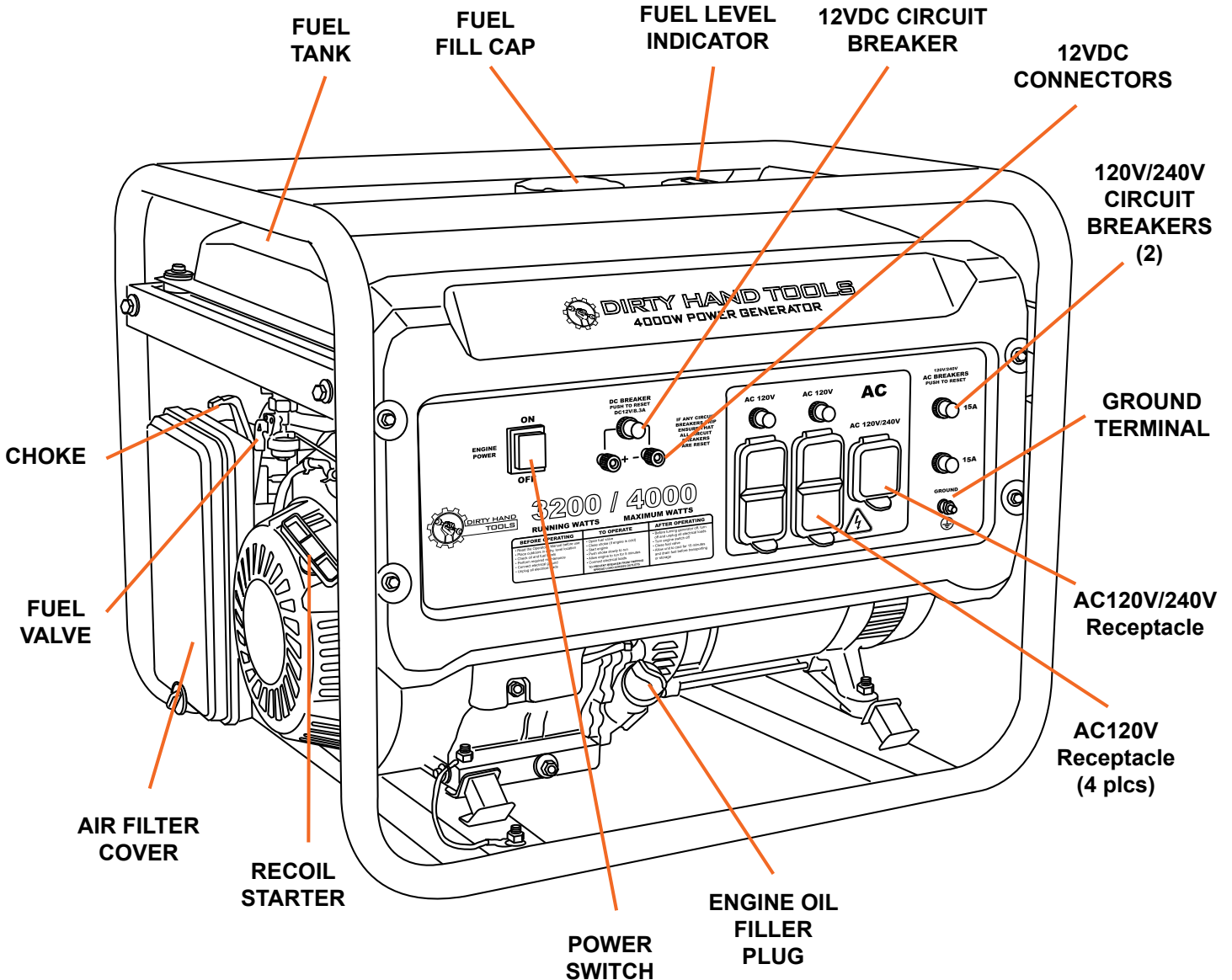

Filling with Gasoline and Oil



WARNING

FUEL IS HIGHLY FLAMMABLE AND POISONOUS

**ALWAYS FILL THE TANK WITH
ENGINE OFF AND COOL.**

**ALWAYS CHECK THE FUEL LEVEL
BEFORE OPERATING.**

Allow the engine to cool for at least two minutes before removing the fuel cap.

1. Place the portable power generator on a level surface. Set up the generator outdoors in a well-ventilated, dry area, away from building air intakes. The generator should be protected from direct exposure to rain and snow. Do not set up the generator on a conductive surface such as a metal deck.
2. The fuel tank holds approximately 4 gallons of fuel. 87+ octane unleaded gasoline is recommended. Do not fill above the top of the fuel filter. Replace the fuel cap securely and wipe any excess from the fuel tank before starting the generator.



WARNING

**DO NOT REFUEL INDOORS OR NEAR ANY SOURCE
OF POSSIBLE COMBUSTION.**

DO NOT SMOKE WHILE FUELING.

DO NOT OVERFILL.

**THE GENERATOR IS SHIPPED WITHOUT FLUIDS.
YOU MUST ADD OIL BEFORE STARTING THE
ENGINE.**

3. Add engine oil to the upper level of the oil filler hole. SAE 10/30 motor oil is recommended for most environmental conditions. The oil capacity is 0.63 quarts (0.6L).

Note: Do not thread the dipstick in when checking the oil level.

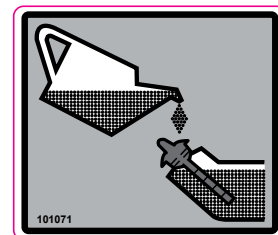
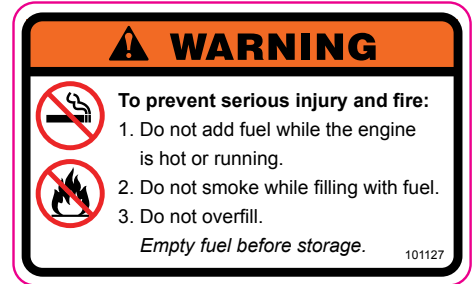

Operation Precautions



DANGER

CARBON MONOXIDE HAZARD USING A GENERATOR INDOORS CAN KILL YOU IN MINUTES.

Generator exhaust contains carbon monoxide.
This is a poison you cannot see or smell.

1. Keep all safety guards in place and in proper working order at all times.
2. NEVER place fingers, hands, or body near the generator when it is running. Do not lean or reach over the generator when the machine is running.
3. Keep all people (except the operator) a minimum of six feet from the generator during operation.
4. Do not transport the generator with the engine running.
5. Operate on level ground. Do not tilt the machine while the engine is running.
6. Do not leave the generator unattended when it is running. Turn off the engine before leaving the area.
7. Do not operate in explosive atmospheres, such as in the presence of flammable liquids, gases, or dust. Gasoline-powered engines may ignite the dust or fumes.
8. Do not use this piece of equipment while tired or under the influence of drugs, alcohol or medication.
9. Parts, especially exhaust system components, get very hot during use. Stay clear of hot parts.
10. Do not cover the generator during operation.

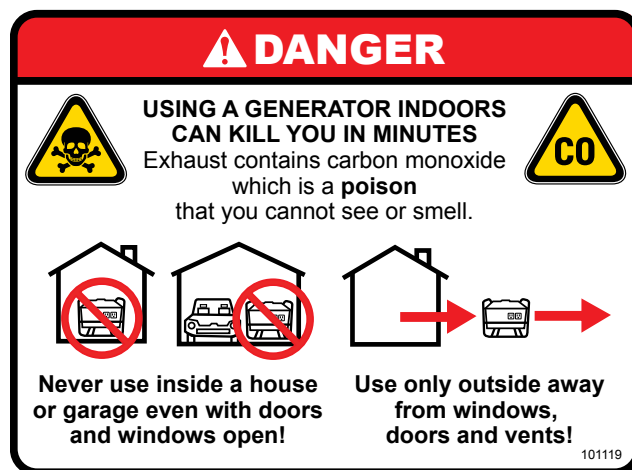

Operation Precautions



CAUTION

This generator is not intended to power sensitive electronic equipment* without the addition of an appropriate line conditioner and surge protector (both not included).

Sensitive electronic equipment, including but not limited to audio/video equipment, television sets, computers, and printers, should be operated on approved inverter type generators or pure sine wave generators. If the plugged in product operates abnormally or unusually slow, immediately stop using the generator as a power source.

1. Before connecting an appliance or power cord to the generator make sure that it is in good working order. Faulty appliances or power cords can create a potential for electrical shock.
2. If an appliance begins to operate abnormally, becomes sluggish or stops suddenly, turn it off immediately. Disconnect the appliance, and determine whether the problem is the appliance, or if the rated load capacity of the generator has been exceeded.
3. Make sure that the electrical rating of the tool or appliance does not exceed that of the generator. Never exceed the maximum power rating of the generator. Power levels between rated and maximum may be used for no more than 30 minutes.
4. Substantial overloading will open the circuit breaker. Exceeding the time limit for maximum power operation or slightly overloading the generator may not switch the circuit breaker OFF, but will shorten the service life of the generator.
5. Connect the generator only to an electrical system (120V~) that is compatible with the electrical characteristics and rated capacities of the generator.
6. Set up the generator outdoors in a well-ventilated, dry area, away from building air intakes. The generator should be protected from direct exposure to rain and snow. Do not set up the generator on a conductive surface such as a metal deck.

Calculating Total Wattage

Before using the generator, calculate the total wattage of all the devices that you want to power at the same time. The total must not exceed the Running Wattage of the generator (3200 watts).

1. Add up the Running Watts for all appliances/tools that you want to use at the same time.
2. Make sure that the total calculated wattage is less than the Rated Wattage of the generator (3200 watts).
3. Find the single highest starting rate wattage product and add that to the total.
4. Make sure that this total now is less than the Maximum Wattage of the generator (4000 watts maximum).
5. Plug in and turn on appliances/tools from the largest wattage first to the smallest wattage last.

Product Wattage Estimation Chart*

1. Add up the Running Watts for all appliances/tools that you want to use at the same time.
2. Make sure that the total calculated wattage is less than the Rated Wattage of the generator.
3. Find the single highest starting rate wattage product and add that to the total.
4. Make sure that this total now is less than the Maximum Wattage of the generator.
5. Plug in and turn on appliances/tools from the largest wattage first to the smallest wattage last.

HOUSEHOLD APPLIANCES		
DEVICE	RUNNING WATTS	ADDITIONAL START-UP WATTS
Battery Charger - 15 Amp	380	0
Clock Radio	100	0
Computer w/ Monitor	800	0
Electric Clothes Dryer	5500	500
Electric Range	2100	0
Electric Water Heater	2000	0
Light Bulb - 100W	100	0
Microwave Oven - 1000W	1000	200
Mini -Refrigerator	400	700
Refrigerator/Freezer	700	1500
Sump Pump - 1/2HP	1000	1100
Television - 27"	400	0
Ten 75W Light Bulbs	750	0
Washing Machine	1100	1100
Well Pump - 1/2HP	1000	1000

POWER TOOLS		
DEVICE	RUNNING WATTS	ADDITIONAL START-UP WATTS
Air Compressor - 1/2 HP	1000	1000
Belt Sander - 3"	1200	1200
Electric Drill - 1/2"	600	600
Reciprocating Saw	900	900
Table Saw - 10"	1700	1300
Work Light - Halogen	1000	0

YARD TOOLS		
DEVICE	RUNNING WATTS	ADDITIONAL START-UP WATTS
Edger	1000	1000
Hedge Trimmer	1400	1400
Lawn Mower	1200	1200
Pressure Washer	1200	1200

RECREATIONAL		
DEVICE	RUNNING WATTS	ADDITIONAL START-UP WATTS
AM/FM Radio	1000	0
Box Fan - 20"	200	200
CD/DVD Player	100	0
Coffee Maker	600	0
Electric Grill	1700	0
Tire Pump	50	100

HVAC HEATING/COOLING		
DEVICE	RUNNING WATTS	ADDITIONAL START-UP WATTS
Air Conditioner 10,000 BTU	1500	1500
Furnace Fan - 1/2HP	900	1400
Space Heater	1800	0
Window AC - 10,000 BTU	1200	600

*Appliances and tools listed are for example only and are typical wattage consumption for that type of device. Check the Owner's Manual or the specifications for each device used to determine actual wattage usage.

To Calculate Wattage

Volts and amps can be multiplied together to get watts.
(volts x amps = watts)

To Calculate Additional Start-Up Watts

For equipment with a motor use the rated watts amount as an estimate of additional start-up watts. For most lights or heaters there are no additional start-up watts.





CAUTION

ONLY AFTER THE GENERATOR IS RUNNING SMOOTHLY SHOULD AN APPLIANCE OR TOOL BE PLUGGED INTO THE AC OUTLET OF THE GENERATOR.

1. Prior to each use, connect a #6 AWG grounding wire (not included) from the ground terminal on the control panel to a grounding rod (not included) that has been driven at least 24 inches deep into the earth. The grounding rod must be an earth-driven copper or brass rod (electrode).
2. Turn the engine's fuel valve to the OPEN position (see Figure 1).
3. Turn the engine's choke lever to the START position (see Figure 2). Set the choke lever to the run position only when the engine has started or upon restarting a warm engine.
4. Turn the engine power switch to the ON position.
5. Pull the recoil starter handle slowly until you meet some resistance. Pull the recoil starter with a rapid full arm stroke allowing the starter rope to rewind slowly. Repeat as necessary until the engine starts running.
6. After the engine warms up and starts running normally, move the choke lever to the RUN position (see Figure 3).

Note: Allow the engine to warm up for about 3 minutes before moving the choke lever to the RUN position.

7. The first 25 hours of operation is the break-in period.

Breaking-in the engine will help ensure proper equipment and engine operation, and will extend the engine's lifespan. During this time frame, **DO NOT** exceed 75% of the generator's load limit. In other words, the maximum load during this break-in period should be no more than 3000 watts. After the first 25 hours of use drain and replace the engine oil.



CAUTION

The warranty is void if the engine is not broken in properly.

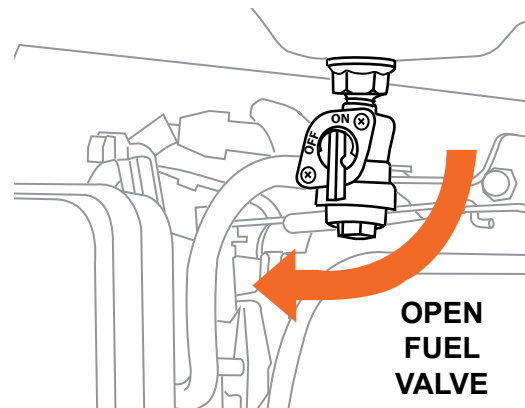

Figure 1

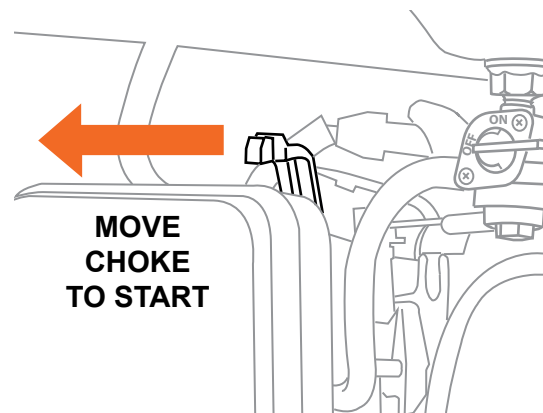

Figure 2

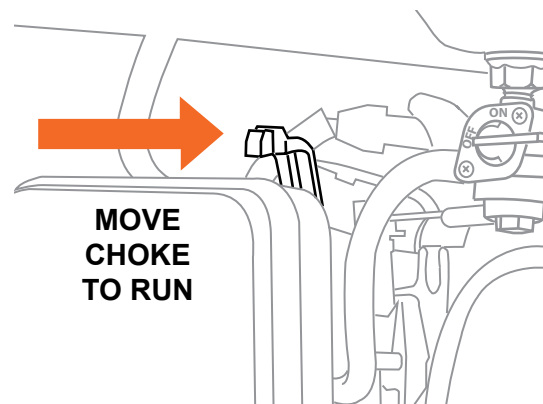
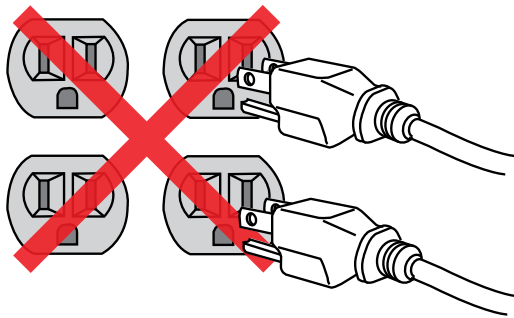
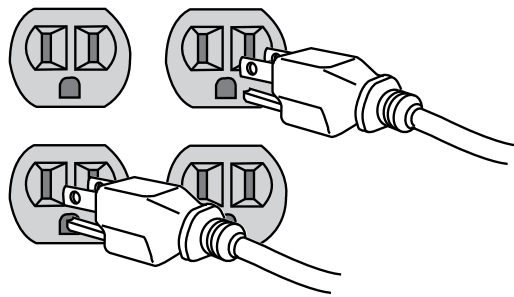

Figure 3

Operation



Incorrect Load



Correct load

Figure 4

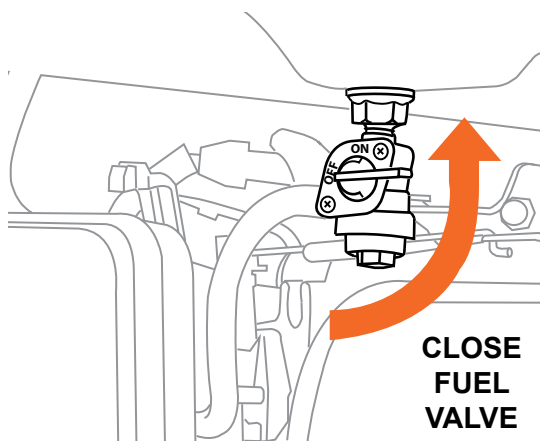

Figure 5

- Load And Circuit Breaker:** The total combined load through the outlet on the generator must not exceed the rated maximum power (4000 watts) of the unit. Always reduce the load if the AC circuit breaker turns off. Once the load is reduced, press the breaker to reset the generator and continue operation.
- Calculating Power Draw:** Power draw can be calculated by multiplying volts and amps. The resulting number is wattage. Never exceed the rated maximum wattage (4000 watts) for the generator. Refer to appliance/tool owner's manuals to determine the wattage of electrical load devices.

Note: Long power cords and extension cords draw additional power. Keep cord length at a minimum.

- AC Application:** Allow the engine to run at no load until warm (approx. 3 minutes) after each start-up to allow the engine to stabilize.
- Plug the power cords of the 120 volt appliance(s) into the 120 volt AC outlets on the generator. Use caution to distribute the load evenly over the outlets (see Figure 4). Add devices according to the largest wattage usage first.



CAUTION

Do not allow the generator to completely run out of fuel with devices attached. A generator's output may sharply spike as it runs out of fuel, causing damage to attached devices.

- When finished using the appliance(s) unplug power cords from the AC outlets on the generator before shutting the generator off.
- Generator Shut Off:** Remove all electrical load devices from the generator. Allow the engine to run for approximately 3 minutes with no electrical load.
- Turn the generator's power switch to OFF to stop the engine.
- Turn the fuel valve to the OFF position (see Figure 5).
- Allow the generator to completely cool down before storing, at least 20 minutes.
- For any lengthy time of storage, more than 20 days, completely empty the fuel from the generator's fuel tank and engine's fuel lines. Cover and store in a well ventilated area.

Maintenance



WARNING

BEFORE PERFORMING ANY MAINTENANCE PROCEDURE STOP THE ENGINE, WAIT FIVE (5) MINUTES TO ALLOW ALL PARTS TO COOL.

Disconnect the spark plug wire, keeping it away from the spark plug.

Regular maintenance is the way to ensure the best performance and long life of your machine. Please refer to this manual and the engine manufacturer's owner's manual for maintenance procedures.

Maintenance Checklist

Maintenance Procedure	Before Each Use	Monthly/ 20 Hours	Every 6 Mo./ 100 Hours	Annually/ 300 Hours
Check Engine Fuel Level	X	X	X	X
Check General Equipment Condition	X			
Check Air Cleaner	X		X	X
Check Fuel Strainer	X		X	X
Clean/Replace Air Filter*		X	X	X
Check/Clean Spark Plug			X	X
Check/Adjust Idle Speed			X	X
Check/Adjust Valve Clearance			X	X
Clean Fuel Tank, Strainer & Carburetor			X	X
Clean Combustion Chamber**				X
Replace Fuel Lines**				X

* Change/clean air filter more frequently if in dusty environment

** Service performed by qualified technician



WARNING

TO PREVENT SERIOUS INJURY FROM ACCIDENTAL STARTING TURN THE POWER SWITCH OF THE ENGINE TO ITS “OFF” POSITION.

Wait for the engine to cool, and remove the spark plug wire before performing any inspection, maintenance, or cleaning procedures.

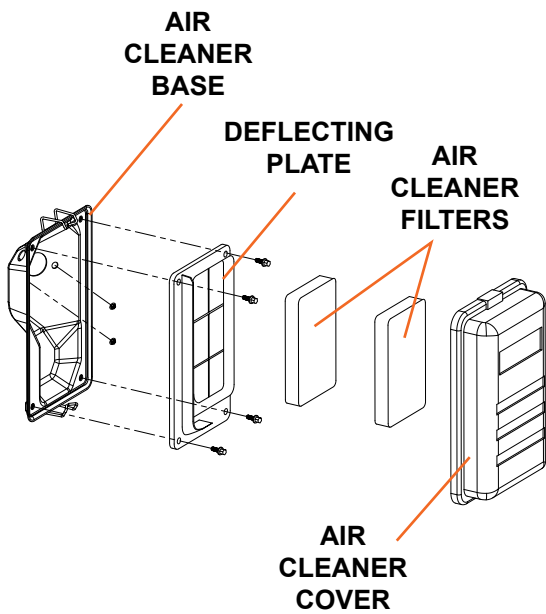

Figure 6

Changing /Cleaning the Air Filter

1. Wipe off the air cleaner cover. Loosen the clips that retain the air filter cover on the top and the bottom (see Figure 6).
2. Remove the air cleaner filters and deflecting plate.
3. Wash the air filters in warm water and mild detergent several times. Rinse. Squeeze out excess water and allow it to dry completely. Soak the filters in lightweight oil briefly, then squeeze out the excess oil.
4. Install new air filters or reinstall the cleaned air filters. Secure the air cleaner cover by before use.

Spark Plug Maintenance:

1. Disconnect spark plug wire from end of plug. Clean out debris from around the spark plug.
2. Using the spark plug wrench provided, remove the spark plug. Inspect the spark plug. If the electrode is oily, clean it using a clean, dry rag. If the electrode has deposits on it, polish it using emery paper. If the white insulator is cracked or chipped, replace the spark plug.
3. When installing a new spark plug, adjust the plug's gap to the specification on the technical specification chart. Do not pry against the electrode or the insulator, the spark plug can be damaged (see Figure 7).
4. Install the new spark plug or the cleaned spark plug into the engine. Gasket style spark plugs should be finger-tightened until the gasket contacts the cylinder head, then turned about 1/2 to 2/3 more rotation. Non-gasket-style spark plugs should be finger-tightened until the plug contacts the head, then about 1/16 turn more.

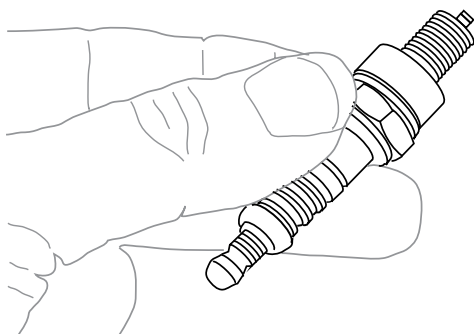

Figure 7



WARNING

OIL IS VERY HOT DURING OPERATION AND CAN CAUSE BURNS. WAIT FOR ENGINE TO COOL BEFORE CHANGING OIL.

Wait for the engine to cool, and remove the spark plug wire before performing any inspection, maintenance, or cleaning procedures.

Changing the engine oil

1. Make sure the engine is stopped and is level.
2. Close the fuel valve.
3. Place a drain pan underneath the crankcase's drain plug.
4. Remove the drain plug and, if possible, tilt the crankcase slightly to help drain the oil out.
5. Replace the drain plug and tighten it.
6. Clean the top of the dipstick and the area around it. Remove the dipstick by threading it counterclockwise, and wipe it off with a clean lint free rag.

Note: Do not thread the dipstick in when checking the oil level.

7. Add the appropriate type of oil until the oil level is at the full level. SAE 10W-30 oil is recommended for general use for temperatures above 32°F. Use SAE 5W-30 for temperatures consistently below 32°F.
8. Thread the dipstick back in clockwise.



WARNING

DO NOT RUN THE ENGINE WITH TOO LITTLE OIL. THE ENGINE WILL BE PERMANENTLY DAMAGED.

SAE VISCOSITY GRADES

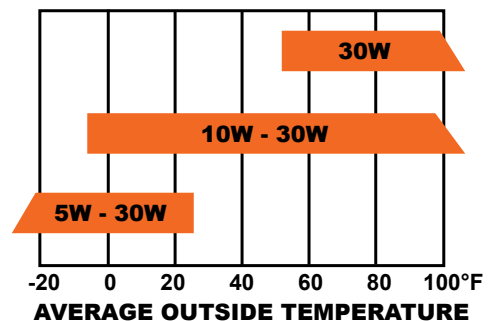

Engine Troubleshooting



WARNING

BEFORE PERFORMING ANY MAINTENANCE PROCEDURE STOP THE ENGINE, WAIT FIVE (5) MINUTES TO ALLOW ALL PARTS TO COOL.

Disconnect the spark plug wire, keeping it away from the spark plug.

PROBLEM	SOLUTION
<p>The engine will not start.</p> <ul style="list-style-type: none"> • No fuel in tank or fuel valve closed. • Choke not in start position. • Low quality or deteriorated, old gasoline. • Dirty fuel passageways blocking fuel flow. • Carburetor needle stuck. Smell of fuel in air. • Too much fuel in chamber. • Spark plug wire not connected securely. • Spark plug electrode wet or dirty. • Incorrect spark plug gap. • Spark plug wire or spark plug broken. • Cylinder not lubricated after long storage. • Clogged fuel filter. 	<ul style="list-style-type: none"> • Add fuel and open fuel valve. • Place choke in START position and pull recoil starter. • Drain fuel. Add fresh 87+ octane unleaded gasoline. • Clean out fuel passageways using fuel additive. • Gently tap side of carburetor with screwdriver handle. • Turn choke to RUN position. • Connect spark plug wire securely to spark plug. • Remove and clean spark plug. Reinstall spark plug and restart. • Reset spark plug gap according to specifications. • Replace spark plug and/or spark plug wire. • Remove spark plug. Pour tablespoon of oil into spark plug hole. Replace spark plug. Crank engine a few times and try to start. • Replace fuel filter. • If the engine still will not start, visit our web site at www.dirtyhandtools.com or call 1-877-487-8275 for assistance.
<p>Engine misfires, backfires or knocks.</p> <ul style="list-style-type: none"> • Spark plug wire loose. • Incorrect spark plug gap. • Spark plug wire or spark plug broken. • Low quality or deteriorated, old gasoline. • Engine too cold. • Engine knocks. 	<ul style="list-style-type: none"> • Tighten spark plug wire. • Reset spark plug gap according to specifications. • Replace spark plug and/or spark plug wire. • Drain fuel. Add new fresh 87+ octane unleaded gasoline. • Use cold weather fuel and oil additives. • Engine overloaded, do not exceed recommended load rating.
<p>Engine stops suddenly.</p> <ul style="list-style-type: none"> • Low quality or deteriorated, old gasoline. • Defective fuel cap creates vacuum. • Improper idle speed. • Incorrect timing, deposit buildup, worn engine or other mechanical problem. 	<ul style="list-style-type: none"> • Drain fuel. Add fresh 87+ octane unleaded gasoline. • Test and replace fuel cap. • Move choke to RUN position. • Requires qualified technician.

Generator Troubleshooting

PROBLEM	SOLUTION
<p>No output from generator's AC receptacle.</p> <ul style="list-style-type: none"> • Engine speed too slow. • Open or shorted wiring. • Faulty capacitor. • Open/shorted rotor or stator windings. • Open rectifier. 	<ul style="list-style-type: none"> • Adjust engine speed. Requires qualified technician. • Clean and reconnect all wiring. • Replace capacitor. • Replace stator windings. • Test rectifier and replace if required.
<p>Low output voltage with no load.</p> <ul style="list-style-type: none"> • Engine speed is too slow. • Open rectifier. • Faulty capacitor. • Open/shorted rotor or stator windings. • Alternator not magnetized. 	<ul style="list-style-type: none"> • Adjust engine speed. Requires qualified technician. • Test rectifier and replace if required. • Replace capacitor. • Replace stator windings. • Re-magnetize the alternator.
<p>High output voltage with no load.</p> <ul style="list-style-type: none"> • Faulty capacitor. • Engine speed is too fast 	<ul style="list-style-type: none"> • Replace capacitor. • Adjust engine speed. Requires qualified technician.
<p>Low output voltage under load.</p> <ul style="list-style-type: none"> • Open rectifier. • Engine speed is too low at full load. • Excessive load applied. • Engine speed is too fast 	<ul style="list-style-type: none"> • Test rectifier and replace if required. • Adjust engine speed. Requires qualified technician. • Reduce the applied load. • Adjust engine speed. Requires qualified technician.
<p>Erratic output voltage.</p> <ul style="list-style-type: none"> • Dirty, corroded, or loose wiring. • Unbalanced load applied. 	<ul style="list-style-type: none"> • Clean and reconnect all wiring. • Remove all loads, then apply each individually to determine which load is causing the erratic output. Do not reconnect the faulty tool or appliance.
<p>Noisy operation.</p> <ul style="list-style-type: none"> • Loose generator or engine bolt. • Short circuit in generator field or load. • Faulty bearing. 	<ul style="list-style-type: none"> • Tighten all mountings. • Test winding resistance, replace field winding if required, test load devices for shorts, replace defective load device(s). • Replace bearing.

Storage

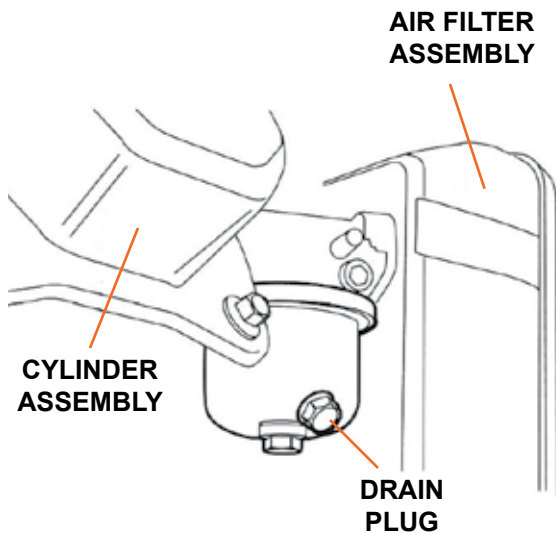

Figure 8

1. Wait for the engine to cool, then clean the engine with a clean cloth.
2. When the generator is to be stored for longer than 20 days, prepare the engine for storage by emptying the fuel tank and draining all fuel lines (see Figure 8). Clean out area around spark plug and remove. Pour one tablespoon of engine oil into the cylinder through the spark plug hole. Reinstall the spark plug, but leave the spark plug wire disconnected. Pull recoil starter handle to distribute oil in the cylinder. Stop after one or two revolutions when you feel the piston start the compression stroke (when you start to feel resistance).
3. Apply a thin coat of rust preventive oil to all uncoated metal parts.
4. Cover and store in a dry, well-ventilated area out of reach of children.

Warranty & Specifications

IMPORTANT NOTICE

We, the manufacturer, reserve the right to change the product and/or specifications in this manual without notification. The manual is for information usage only and the pictures and drawings depicted herein are for reference only.

Warranty Repair and Service

Do not return this product to the store for warranty issues or repair. Call our customer service department at **720-287-5182**, **1-877-487-8275**, or visit www.dirtyhandtools.com for the location of the nearest service center.

Record the information below for future reference.

Model No. _____

Serial No. _____

Date of Purchase _____

Place of Purchase _____

Specifications

SKU/Part No.	101091
Description	4000W Portable Power Generator
Peak Wattage	4000 Watts Maximum
Continuous Wattage	3200 Watts
Circuit Breaker	15 Amps
Power Receptacles	4 - 120V AC, 1 - 120V/240V AC, 1 - 12V DC
Engine	7 HP 212cc* EPA/CARB Approved
Fuel Type	Unleaded Gasoline, 89+ Octane
Spark Plug Gap	0.028"~ 0.031"
Run Time @ 50% Load	10 Hours
Sound Rating	75 dB
Dimensions	23"L x 19"W x 18"H
Weight	119 Lbs.
Accessories	Spark Plug Wrench Included

*As rated by engine manufacturer

Dirty Hand Tools® is a brand of
 **FrictionlessWorld**
1100 W 120th Ave., Suite 600
Westminster, CO 80234 • 720-287-5182

For Service or Questions
Call 1-877-487-8275
720-287-5182
www.dirtyhandtools.com