









# THE HOME DEPOT

## Inspection Requirement

2455 PACES FERRY ROAD  
ATLANTA, GEORGIA 30339-4024

REPORT NO.: 85122610713V11

SKU #:	684661 / USA 684716 / USA 691351 / USA 697384 / USA 699266 / USA 712203 / USA 754761 / USA	MODEL #:	33-BS-1 33-BS-2 33-BS-4 33-BD-1 33-BD-2 33-BD-4 46-BD-3	DEPT. #:	59	COE #:	1
SUPPLIER:	YERSH		SUPPLIER #:		12325		
FACTORY:	XIAMEN UPTRADE FURNISHING INDUSTRIAL CO., LTD.		FACTORY #:		2004423		
FACTORY ADDRESS:	NO.5-11, HUATAI ROAD, HULI, DISTRICT XIAMEN FUJIAN, CHINA						
PRODUCT DESCRIPTION:	MSL 2PC 1-3/8 SBRK WH MSL 2PC 1-3/8 SBRK OAK MSL 2PC 1-3/8 SBRK MAH MSL 2PC 1-3/8 DBRK WH MSL 2PC 1-3/8 DBRK OAK MSL 2PC 1-3/8 DBRK MAH MSL 2PC 1-13/16" SDBRK MAH						

			
33-BS-1	33-BS-2	33-BS-4	33-BD-1
			
33-BD-2	33-BD-4	46-BD-3	
<b>IMPORTANT:</b> The product photos are not intended as the color reference.			

**This product requirement contains the following documents:**

1. Product Requirements
2. Packaging Requirements
3. Product Documentation
4. Product Photos
5. Inspection Plan

Form Owner: THD QA - Issue Date: 6/23/08 - Version #: 4

Proprietary & Confidential  
The Home Depot Company Information

6. Defect classification
7. Revision history

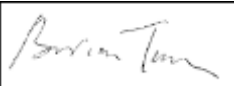
	Prepared by:	Ada Liang	Reviewed by:	Nancy Du	Approved by:	 <b>(Brian Tam)</b>
	Date:	Dec 20, 2012	Date:	Dec 20, 2012	Date:	Dec 20, 2012
	<b>Control-Subcontrol Number:</b>			8034.3442.4107.51721 8034.3442.4107.51722 8034.3442.4107.51724 8034.3442.4107.51725 8034.3442.4107.51727 8034.3442.4107.51729 8034.3442.4107.51768		

# 1. Product Requirements

1.1 GENERAL REQUIREMENT						
Item#	Item	Qty	Style / Feature / Finish / Color	Dimension / Measurement	Tolerance	Material
33-BS-1	MSL 2PC 1-3/8 SBRK Wh	2	WHITE	Dimension: 4.37LinX1.10WinX2.76Hin  Weight: 0.22lbs	For dimension: +/-5%  For weight: +/-10%;	WOOD
33-BS-2	MSL 2PC 1-3/8 SBRK Oak		OAK	Dimension: 4.37LinX1.10WinX2.76Hin  Weight: 0.22lbs		
33-BS-4	MSL 2PC 1-3/8 SBRK Mah		ANT. MAHOGANY	Dimension: 4.37LinX1.10WinX2.76Hin  Weight : 0.22lbs		
33-BD-1	MSL 2PC 1-3/8 DBRK Wh		WHITE	Dimension : 7.20LinX1.10WinX2.76Hin  Weight: 0.34lbs		
33-BD-2	MSL 2PC 1-3/8 DBRK Oak		Oak	Dimension: 7.20LinX1.10WinX2.76Hin  Weight: 0.34lbs		
33-BD-4	MSL 2PC 1-3/8 DBRK Mah		Ant. Mahogany	Dimension: 7.20LinX1.10WinX2.76Hin  Weight: 0.34lbs		
46-BD-3	MSL 2PC 1-13/16" SDBRK Mah		Ant. Mahogany	Dimension: 6.38LinX1.34WinX2.76Hin  Weight: 0.31lbs		
1.2 PRE-PURCHASE TESTING RESULT						
This product must achieve a rating of "Good" under The Home Depot's Pre-Purchase Testing Program or "unsatisfactory" but with THD'S PPT Waiver.		PPT REPORT NO: 85122610713		RATING: GOOD		REMARK: N/A
1.3 PERFORMANCE TESTS						
Test Property	Test Requirement				Comments	
Moisture Content Test of natural wood material only	The moisture content of wood product intended for indoor use shall be within 8%-12%.				Nil	

<p>Coating Adhesion Test on Coating / Painting Component</p>	<p><b>1. Cross Hatching Test:</b> Coated metal items shall be rated per the scale specified in the standard when tested as appropriate. Cut coating as specified, apply tape to cuts, then remove tape after 2 min and examine for removal of coating from substrate. Photograph if any plating / finish is removed. Select cutting method as follows:                  Use the cutter to make parallel cut so that space the cuts 2mm apart and make six cuts: 6 lines (columns) x 6 lines (row) lead to 2mm x 2mm x 25 grids.</p> <p><b>2. Tape Test:</b> Coated nonmetallic component: press the adhesive tape on coating / painting surface apply tape to cuts, remove tape after 2 min and examine for removal of coating from substrate.</p>	<p>Nil</p>
--	--	------------

----- End of This Section -----

## 2. Packaging Requirements

<b>Label Location</b>	Refer to Section 3
<b>Sensormatic Tags</b>	Reference code 1.4.3.1 & 1.4.3.2 in BV IR 600000
<b>UPC/UCC on unit package I 2 of 5 number on master carton (if available)</b>	Reference code 1.4.1.6 & 1.4.1.10 in BV IR 600000, the number should is:
	UPC/UCC number: 33-BS-1:4713105460179 33-BS-2:4713105460186 33-BS-4:4713105460209 33-BD-1:4713105460216 33-BD-2:4713105460223 33-BD-4:4713105460247 46-BD-3:4713105460568
	I 2 of 5 number: 33-BS-1: 14713105460176 33-BS-2: 14713105460183 33-BS-4: 14713105460206 33-BD-1: 14713105460213 33-BD-2: 14713105460220 33-BD-4: 14713105460244 46-BD-3: 14713105460565
<b>CARB label</b>	No.
<b>CARB certificate</b>	No.
<b>Country of Origin</b>	Reference code 1.4.1.2 in IR 600000
	Country of Origin:CHINA
<b>Importer name and address</b>	Reference code 1.4.1.5 in IR 600000
	Importer name and address: Refer to IR600000 - USA
<b>Bilingual requirement for caution and warning statements and any inserts or instruction manual</b>	Reference code 1.4.1.7 in IR 600000
<b>Safety listing Label</b>	Reference code 1.4.1.6 in IR 600000 or Refer to section 3.1
<b>Instruction Sheet</b>	Clear assembly / operating instructions (as applicable) should be identical to those shown in Sec 3
<b>Warranty Card</b>	NO
<b>Unit package</b>	Reference code 1.4.in IR 600000
<b>Unit package Size</b>	(L) x (W) x (H)(in) 33-BS-1/33-BS-2/33-BS-4: 2.64inL x 2.95inW x 6.81inH 33-BD-1/33-BD-2/33-BD-4: 2.64inL x 2.95inW x 8.07inH 46-BD-3: 3.15inL x 2.95inW x 7.60inH
<b>Method</b>	ALL: 1 pair per box, 4 boxes per master carton
<b>SWPM (Solid wooden packing material) is used for product packing</b>	No

Per ECN 15756 & 15751 & 15752, Add hang tab function.



NOTE: These items use same packaging way:  
8034.3442.4107.51721; 8034.3442.4107.51722; 8034.3442.4107.51724; 8034.3442.4107.51725; 8034.3442.4107.51727;  
8034.3442.4107.51729; 8034.3442.4107.51768

ECN 16895, Add one more sticker inside packaging.



Packaging Specification			
SKU No.	684661 684716 691351 697384 699266 712203 754761	Model No.	33-BS-1 33-BS-2 33-BS-4 33-BD-1 33-BD-2 33-BD-4 46-BD-3
Piece count	2	Case count	4
Package component description:	Master Carton Single-Wall corrugated	Unit Packaging Single-Wall corrugated	
Component Material:	Corrugated	Corrugated	
Packaging component per SKU	2/4	2/4	
Component dimension: (in, L x W x D)	33-BS-1/33-BS-2/33-BS-4: 5.91inLx6.50inWx7.95inH 33-BD-1/33-BD-2/33-BD-4: 5.91inLx6.50inWx9.25inH 46-BD-3: 6.69inLx6.69inWx8.74inH	33-BS-1/33-BS-2/33-BS-4: 2.64inLx2.95inWx6.81inH 33-BD-1/33-BD-2/33-BD-4: 2.64inLx2.95inWx8.07inH 46-BD-3: 3.15inLx2.95inWx7.60inH	
Outer Shipping Case (Tick one per SKU)	<input checked="" type="checkbox"/> [ X ]	<input type="checkbox"/> [ ]	<input type="checkbox"/> [ ]
Outbound Load Configuration: (select one)	[ X ] Floor stack [ ] Pallet [ ] Slip sheet [ ] Crate [ ] others, _____		
Gross weight of shipping carton: (lb, includes product)	33-BS-1/33-BS-2/33-BS-4: 2.44 lb. 33-BD-1/33-BD-2/33-BD-4: 3.46 lb. 46-BD-3: 3.72 lb.	Pallet or crate size: (inch, Length X Width, if applicable)	N/A

**NOTES:**

- Other than the specific Packaging Requirement above, for General Packaging Requirement please refer to **IR600000**).
- For any changes of marking, printing, parts and /or components, the vendor should inform The Home Depot. The changes of parts or components may require re-submitting for evaluation.
- Any changes of marking, printing, parts and /or components without informing The Home Depot would be counted as a violation of this Product Requirement.

----- End of This Section -----



### 3. Product Documentation

#### 3.1 (CARB label, CARB certificate, manuals, instruction sheets, parts list, labels, artwork, etc.)

ARTWORK		
For 33-BS-1		
 <p><b>MARATHA LIVING</b>™</p> <hr/> <p><b>1-3/8 IN WOOD BRACKET FOR SINGLE ROD</b></p> <p>SOPORTE DE MADERA DE 3,4 cm PARA VARA SIMPLE</p>	<p>684 661</p> <p><b>WHITE FINISH</b> ACABADO EN BLANCO</p> <p><b>FOR USE WITH 1-3/8 IN POLES</b> PARA USAR CON POSTES DE 3,4 cm</p>	<p>MADE IN CHINA HECHO EN CHINA</p> <p>DISTRIBUTED BY: DISTRIBUIDO POR: HOME DEPOT 2455 PACES FERRY RD., N.W. ATLANTA, GA 30339</p> <p>FOR ASSISTANCE, CALL: SI NECESITA AYUDA, LLAME AL: 1-877-527-0313 HOMEDEPOT.COM</p> <p>MARATHA STEWART LIVING™ and the MARATHA STEWART Circle Logo™ are trademarks of Martha Stewart Living Omnimedia, Inc. Copyright © Martha Stewart Living Omnimedia, Inc. All rights reserved.</p>  
For 33-BS-2		
 <p><b>MARATHA LIVING</b>™</p> <hr/> <p><b>1-3/8 IN WOOD BRACKET FOR SINGLE ROD</b></p> <p>SOPORTE DE MADERA DE 3,4 cm PARA VARA SIMPLE</p>	<p>684 716</p> <p><b>HERITAGE OAK FINISH</b> ACABADO EN ROBLE HERITAGE</p> <p><b>FOR USE WITH 1-3/8 IN POLES</b> PARA USAR CON POSTES DE 3,4 cm</p>	<p>MADE IN CHINA HECHO EN CHINA</p> <p>DISTRIBUTED BY: DISTRIBUIDO POR: HOME DEPOT 2455 PACES FERRY RD., N.W. ATLANTA, GA 30339</p> <p>FOR ASSISTANCE, CALL: SI NECESITA AYUDA, LLAME AL: 1-877-527-0313 HOMEDEPOT.COM</p> <p>MARATHA STEWART LIVING™ and the MARATHA STEWART Circle Logo™ are trademarks of Martha Stewart Living Omnimedia, Inc. Copyright © Martha Stewart Living Omnimedia, Inc. All rights reserved.</p>  
For 33-BS-4		
 <p><b>MARATHA LIVING</b>™</p> <hr/> <p><b>1-3/8 IN WOOD BRACKET FOR SINGLE ROD</b></p> <p>SOPORTE DE MADERA DE 3,4 cm PARA VARA SIMPLE</p>	<p>691 351</p> <p><b>ANTIQUE MAHOGANY FINISH</b> ACABADO EN CAOBA ANTIGUO</p> <p><b>FOR USE WITH 1-3/8 IN POLES</b> PARA USAR CON POSTES DE 3,4 cm</p>	<p>MADE IN CHINA HECHO EN CHINA</p> <p>DISTRIBUTED BY: DISTRIBUIDO POR: HOME DEPOT 2455 PACES FERRY RD., N.W. ATLANTA, GA 30339</p> <p>FOR ASSISTANCE, CALL: SI NECESITA AYUDA, LLAME AL: 1-877-527-0313 HOMEDEPOT.COM</p> <p>MARATHA STEWART LIVING™ and the MARATHA STEWART Circle Logo™ are trademarks of Martha Stewart Living Omnimedia, Inc. Copyright © Martha Stewart Living Omnimedia, Inc. All rights reserved.</p>  
For 33-BD-1		

	<p>697 384</p>	<p>MADE IN CHINA HECHO EN CHINA</p>  <p>Recycle Recicla</p> <p>DISTRIBUTED BY: DISTRIBUIDO POR: HOME DEPOT 2455 PACES FERRY RD., N.W. ATLANTA, GA 30339</p> <p>FOR ASSISTANCE, CALL: SI NECESITA AYUDA, LLAME AL: 1-877-527-0313 HOMEDEPOT.COM</p> <p>MARTHA STEWART LIVING™ and the MARTHA STEWART Circle Logo™ are trademarks of Martha Stewart Living Omnimedia, Inc. Copyright © Martha Stewart Living Omnimedia, Inc. All rights reserved.</p>
<p><b>1-3/8 IN WOOD BRACKET FOR DOUBLE ROD</b></p> <p>SOPORTE DE MADERA DE 3,4 CM PARA VARA DOBLE</p>	<p><b>WHITE FINISH ACABADO EN BLANCO</b></p> <p><b>FOR USE WITH 1-3/8 IN POLES PARA USAR CON POSTES DE 3,4 CM</b></p>	 <p>4 1713105 460216</p>

For 33-BD-2

	<p>699 266</p>	<p>MADE IN CHINA HECHO EN CHINA</p>  <p>Recycle Recicla</p> <p>DISTRIBUTED BY: DISTRIBUIDO POR: HOME DEPOT 2455 PACES FERRY RD., N.W. ATLANTA, GA 30339</p> <p>FOR ASSISTANCE, CALL: SI NECESITA AYUDA, LLAME AL: 1-877-527-0313 HOMEDEPOT.COM</p> <p>MARTHA STEWART LIVING™ and the MARTHA STEWART Circle Logo™ are trademarks of Martha Stewart Living Omnimedia, Inc. Copyright © Martha Stewart Living Omnimedia, Inc. All rights reserved.</p>
<p><b>1-3/8 IN WOOD BRACKET FOR DOUBLE ROD</b></p> <p>SOPORTE DE MADERA DE 3,4 CM PARA VARA DOBLE</p>	<p><b>HERITAGE OAK FINISH ACABADO EN ROBLE HERITAGE</b></p> <p><b>FOR USE WITH 1-3/8 IN POLES PARA USAR CON POSTES DE 3,4 CM</b></p>	 <p>4 1713105 460223</p>

For 33-BD-4

	<p>712 203</p>	<p>MADE IN CHINA HECHO EN CHINA</p>  <p>Recycle Recicla</p> <p>DISTRIBUTED BY: DISTRIBUIDO POR: HOME DEPOT 2455 PACES FERRY RD., N.W. ATLANTA, GA 30339</p> <p>FOR ASSISTANCE, CALL: SI NECESITA AYUDA, LLAME AL: 1-877-527-0313 HOMEDEPOT.COM</p> <p>MARTHA STEWART LIVING™ and the MARTHA STEWART Circle Logo™ are trademarks of Martha Stewart Living Omnimedia, Inc. Copyright © Martha Stewart Living Omnimedia, Inc. All rights reserved.</p>
<p><b>1-3/8 IN WOOD BRACKET FOR DOUBLE ROD</b></p> <p>SOPORTE DE MADERA DE 3,4 CM PARA VARA DOBLE</p>	<p><b>ANTIQUE MAHOGANY FINISH ACABADO EN CAOBA ANTIGUO</b></p> <p><b>FOR USE WITH 1-3/8 IN POLES PARA USAR CON POSTES DE 3,4 CM</b></p>	 <p>4 1713105 460247</p>



For 46-BD-3

	<p>754 761</p>	<p>MADE IN CHINA HECHO EN CHINA</p>	
<p>1-13/16 IN BRACKET FOR DOUBLE ROD SOPORTE DE MADERA DE 4,6 CM PARA VARA DOBLE</p>	<p>ANTIQUE MAHOGANY FINISH ACABADO EN CAOBA ANTIGUO FOR USE WITH 1-13/16 IN POLES PARA USAR CON POSTES DE 4,6 CM</p>	<p>DISTRIBUTED BY: DISTRIBUIDO POR: HOME DEPOT 2455 PACES FERRY RD., N.W. ATLANTA, GA 30339</p>	<p>Recycle Recicla</p>
		<p>FOR ASSISTANCE, CALL: SI NECESITA AYUDA, LLAME AL: 1-877-527-0313 HOMEDEPOT.COM</p>	
		<p>MARTHA STEWART LIVING™ and the MARTHA STEWART Circle Logo™ are trademarks of Martha Stewart Living Omnimedia, Inc. Copyright © Martha Stewart Living Omnimedia, Inc. All rights reserved.</p>	

Original Illustration:

Per ECN 21914, change metal plate, wall anchor, screw and instruction manual.

<p><b>Step 1</b></p> <p>Step 1: Loosen screws SLIGHTLY, just enough to pull or slide the metal plate sideways. Remove metal plate from the bracket. *DO NOT REMOVE SCREWS!</p> <p>Paso 1: Afloje un poco el tornillo, lo suficiente para tirar o deslizar la placa de metal hacia un lado. Saque la placa de metal del soporte. *NO SAQUE EL TORNILLO.</p>	<p>2B: For mounting metal plate to drywall: Insert anchors into wall and insert screws into wall anchors.</p> <p>2B: Para montar la placa de metal en un panel de yeso: Inserte las anclas a los agujeros y luego inserte los tornillos a las anclas.</p>
<p><b>Step 2</b></p> <p>2A: For mounting metal plate to wood or studs: Pre-drill two pilot holes on the wall (3/16" drill bit) for each bracket. Mounting metal plate to wall with provided screws.</p> <p>2A: Para montar la placa de metal en madera o corchete: Taladre previamente dos agujeros piloto en la pared (3/16" broca) para cada soporte, despues monte la placa metal a la pared con tornillos</p>	<p><b>Step 3</b></p> <p>Step 3: Slip brackets over mounted metal plate. Make sure both screws on the brackets are firmly clipped onto the mounted metal plate. *If you feel the brackets are not tightly fixed on the wall, remove brackets and tighten the screws slightly and repeat Step 3.</p> <p>Paso 3: Deslice los soportes sobre la placa de metal montada. Asegurese de que los tornillos de los soportes estén firmemente unidos a la placa metal montada. *Si siente que los soportes no están firmemente sujetados en la pared, quite los soportes, aprete un poco más los tornillos y repita el Paso 3.</p>
	<p><b>Step 4</b></p> <p>Fix wood pole by inserting screws into bracket. Screw finials onto wood pole.</p> <p>Adjunte el palo de madera insertando los tornillos al soporte. Atornille los extremos a la pieza.</p>

Per ECR-2483, 1. Revise step 2A change the pilot hole from 3/16 inch to 1/8 inch; 2. Revise step 2B specify how the drywall anchors are to be installed. The requested implementation date is 04/01/2016.

New Illustration:

## Step1

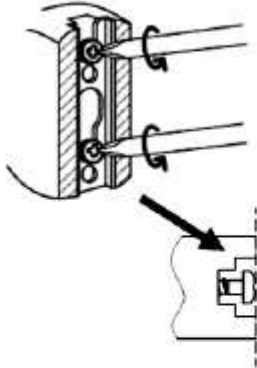

Step 1: Loosen screws **SLIGHTLY**, just enough to pull or slide the metal plate sideway. Remove metal plate from the bracket.

**\*DO NOT REMOVE SCREWS!**

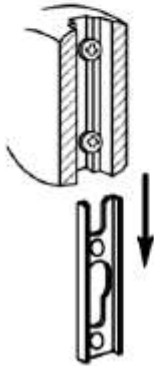

Paso 1: Afloje un poco el tornillo, lo suficiente para tirar o deslizar la placa de metal hacia un lado. Saque la placa de metal del soporte.

**\*NO SAQUE EL TORNILLO.**

Step2

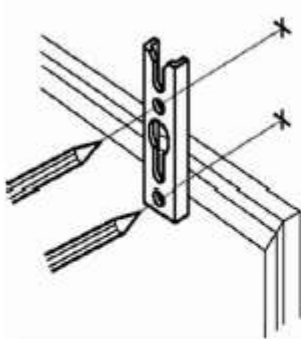

2A: For mounting metal plate to wood or studs:

Pre-drill two pilot holes on the wall (1/8" drill bit) for each bracket. Mounting metal plate to wall with provided screws.

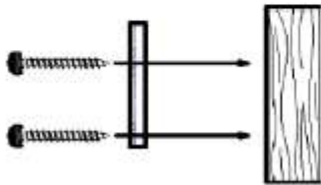

2A: Para montar la placa de metal en madera o corchete:

Taladre previamente dos agujeros pilotos en la pared (1/8" broca) para cada soporte, despues monte la placa metal a la pared con tornillos

-1-

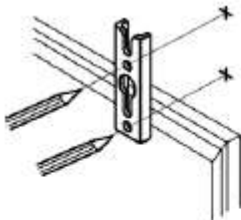

2B: For mounting metal plate to drywall:

Use a screwdriver to screw self-drilling drywall anchors into wall and insert screws into anchors.

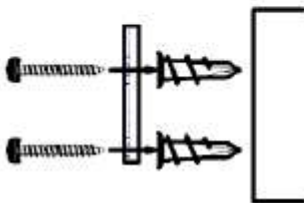

2B: Para montar la placa de metal en un panel de yeso:

Use un desármador para atornillar los tacos de anclaje a la pared e inserte los tornillos en los tacos.

Step 3

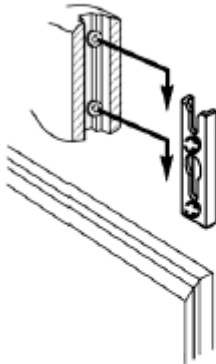

Step 3: Slip brackets over mounted metal plate. Make sure both screws on the brackets are firmly clipped onto the mounted metal plate. \*If you feel the brackets are not tightly fixed on the wall, remove brackets and tighten the screws slightly and repeat Step 3.

Paso 3: Deslize los soportes sobre la placa de metal montada. Asegurese de que los tornillos de los soportes estén firmemente unidos a la placa metal montada. \*Si siente que los soportes no están firmemente sujetos en la pared, quite los soportes, aprete un poco más los tornillos y repita el Paso 3.

Step 4

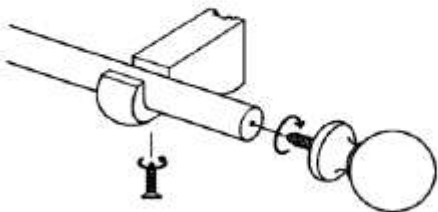

Fix wood pole by inserting screws into bracket.  
Screw finials onto wood pole.

Adjunte el palo de madera insertando los tornillos al soporte.  
Atornille los extremos a la pieza.

-2-



Components' Net Weight:

Product Description	PQOB INDEX#	SKU#	REPORT#	1 of 5 (外箱箱碼)	PCB per sale unit	Component's net weight (g)		
						銀片	螺絲 1	螺絲包
MSL 2PC 1-3/8" SBRK WH	8034 3442 4107 51721	684661	(8512)261-0713	14713105460176	1 pair	13.00	8.80	6.50
MSL 2PC 1-3/8" SBRK OAK	8034 3442 4107 51722	684716	(8512)261-0713	14713105460183	1 pair	13.00	8.80	6.50
MSL 2PC 1-3/8" SBRK MAH	8034 3442 4107 51724	691351	(8512)261-0713	14713105460206	1 pair	13.00	8.80	6.50
MSL 2PC 1-3/8" DBRK WH	8034 3442 4107 51725	697384	(8512)261-0713	14713105460213	1 pair	13.00	8.80	7.80
MSL 2PC 1-3/8" DBRK OAK	8034 3442 4107 51727	699266	(8512)261-0713	14713105460220	1 pair	13.00	8.80	7.80
MSL 2PC 1-3/8" DBRK MAH	8034 3442 4107 51729	712203	(8512)261-0713	14713105460244	1 pair	13.00	8.80	7.80
MSL 2PC 1-13/16" SDBRK MAH	8034 3442 4107 51768	754761	(8512)261-0713	14713105460565	1 pair	13.00	8.80	8.50

Per ECN 16012, Updated the smaller hole to the groove.

# The original bracket

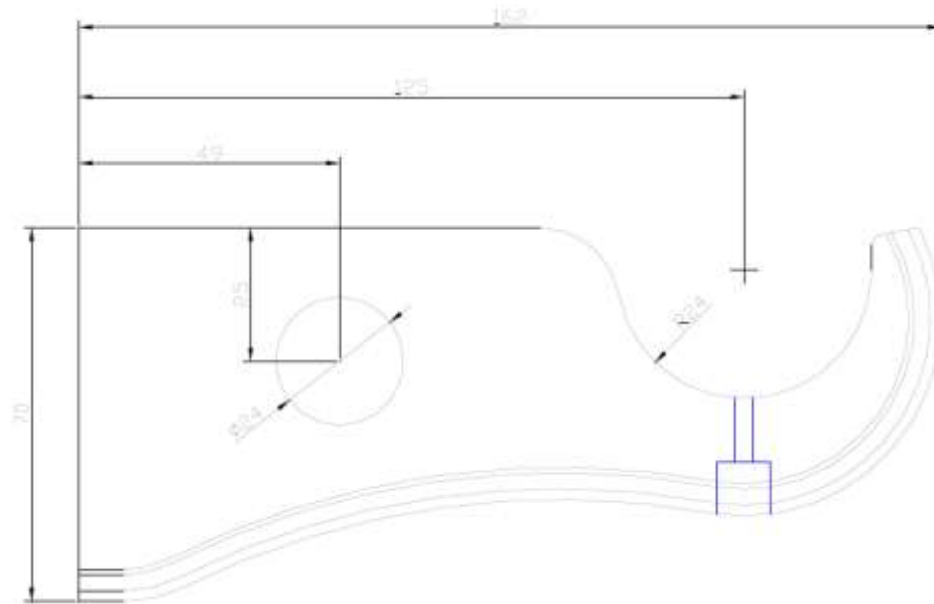

# The revised bracket

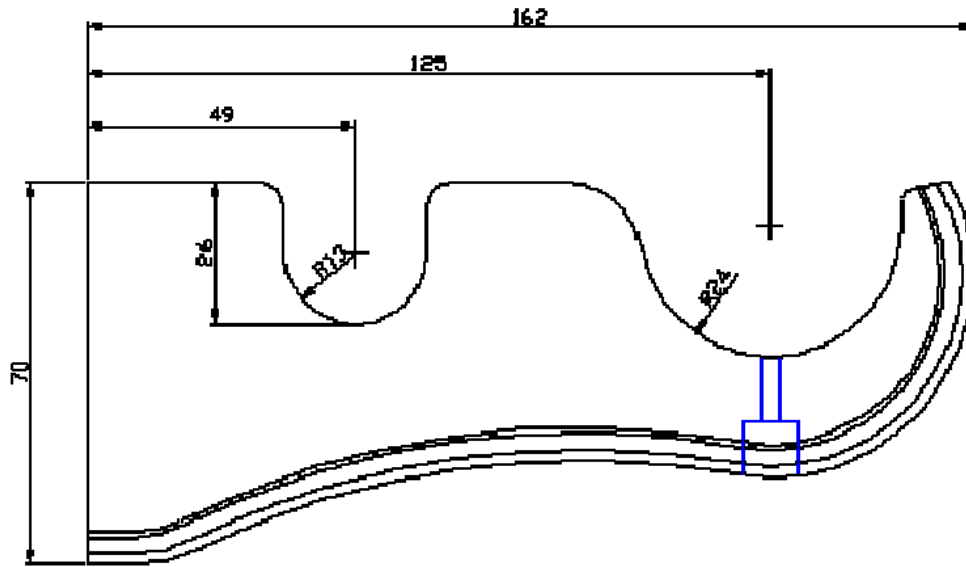

----- End of This Section -----



4. Product Photos

1	Overall view For 33-BS-1	2	Overall view For 33-BS-2
			
3	Overall view For 33-BS-4	4	Overall view For 33-BD-1
			
5	Overall view For 33-BD-2	6	Overall view For 33-BD-4
			

7	Overall view For 46-BD-3	8	Product detail view
			
9	Product detail view	10	Product detail view
			
11	Product detail view	12	Product detail view
			

13	Product detail view	14	Product detail view
			
15	Product detail view	16	Product detail view
			
17	Product detail view	18	Per ECN 16593, Electroplating layer color change from trivalent blue zinc to trivalent black zinc.
			

Per ECN 21914, change metal plate, wall anchor, screw and instruction manual.

**Change the gap from 4.8mm to 5.4mm**



We found that sometime screws is too close to the metal plate gap after fixing the screws into the bottom of bracket. Sometimes this will cause it too tight to remove it.

We will change metal plate gap from the lower limit 4.8mm to upper limit 5.4mm. This will provide more room between screws and metal plate, let customer more easily to take apart metal plate.

Current

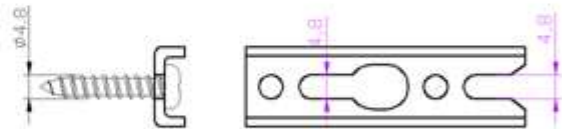

Improved

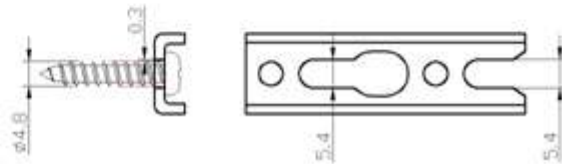

- We'll change current anchor to drywall anchor to avoid similar problem happened again.

Current anchor

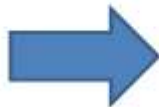

Drywall anchor



- We'll change the screw head to Philips Slotted head. Customer can use both types of screw driver.



Current

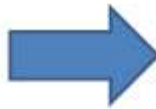

Improved



Philips  
Slotted >

**IMPORTANT:** The product photos are not intended as the color reference

----- End of This Section -----

## 5. Inspection Plan

### 5.1 General Inspection Requirement

➤ **Product:**

- ✧ Must be without any unsafe defect;
- ✧ Should be free of Cosmetic/Aesthetic defects such as: damaged/broken parts/pieces, scratches, cracks, etc.;
- ✧ Must conform to the country of destination's legal regulations;
- ✧ The unit should comply with client's requirement / approved sample (appearance and function);
- ✧ Marking(s) / label(s) on unit should be clear and should comply with legal requirements.

➤ **Packaging:**

- ✧ All units will be adequately packaged, and constructed from suitably robust materials, such that it arrives to stores in a sellable condition;
- ✧ The packaging material can protect the goods from damage during transportation;
- ✧ The shipping mark, bar code, label (such as price label), should conform to client's spec and/or approved samples;
- ✧ The packaging should comply to client's requirement / approved sample;
- ✧ Text of illustration, instruction, label and warning statement etc. must be clearly printed in user's language;
- ✧ The illustration, instruction and claim on the packaging artwork / labels must conform to the product appearance and its actual performance;
- ✧ The method and material of pallet / crate etc. should be approved by client.

➤ **Inspection Standard Adopted:**

- ✧ Refer to “THD Inspection Sampling Tool”

➤ **Sample Size determination:**

- ✧ The Inspection Level Shall refer to Most Updated Switching Rules of The Home Depot.
- ✧ Please Refer to table 5.3 to determine sample size for each audit area
- ✧ Please use “THD Inspection Sampling Tool” to generate the appropriate each SKU sample size for every PSI, which includes multiple SKUs combined in one PSI lot.
- ✧ For the inspection plan is Fix sample size, each SKU shall be drawn according to the required fix sample quantity which cannot be combined.

➤ **Acceptable Quality Level:**

- ✧ Critical Non-conformity is not allowed
- ✧ **AQL 1.0** (or special approved by THD) For Major Non-Conformity
- ✧ **AQL 4.0** (or special approved by THD) For Minor Non-Conformity

➤ **For checking item that adopt “Fix sample size”, nonconformity is not allowed.**

➤ **General defect classification:**

- ✧ **Critical Defect**
  - ◆ Defects that could result in hazardous or unsafe conditions for individuals using or maintaining the product as well as defects contravening legal regulations.
- ✧ **Major Defect**
  - ◆ Functional defects reducing the usability or solidity of the product as well as obvious visual defects reducing the sales value of the product.
- ✧ **Minor Defect**
  - ◆ Defects that are unlikely to reduce the use of the product, but nevertheless may influence the sale.

➤ **For random inspection, the following rules are applied:**

- ✧ If the same sample has several defects, only the most serious defect is counted.
- ✧ Samples with defect have to be replaced or repaired; In the case of critical defects, the entire shipment must be rejected.



## 5.2 Equipment List

<b>SP Equipment</b>	<b>Factory Equipment</b>
<ol style="list-style-type: none"><li>1. Metal tape</li><li>2. Bar code reader</li><li>3. 3M tape/ruler/cutter</li><li>4. Moisture content meter</li></ol>	<ol style="list-style-type: none"><li>1. Weight scale</li></ol>



### 5.3 Inspection Checklist

Item code	Details	Sampling size
1	<b>Packaging Check</b>	
A	Appearance of master carton	At least the square root of the total number of shipping package units, or otherwise defined by client, And check all cartons/ pallets/crates that were selected for sampling.
B	Shipping mark	
C	Strapping method of master carton	
D	Pack size	
2	<b>Aesthetics / Appearance Check</b>	
A	Instruction (sheet)/warning/warranty	Inspection Level ###
B	Appearance of unit	
C	Accessories	
D	Unit packaging	
3	<b>Bar Code Verification</b>	Inspection Level ###
4	<b>Data Measurement and Test</b>	
A	Size and weight of unit	S-1 per shipment lot, but at least 2 pcs per SKU if quantity of related SKU exceeds sample size according to S-1.
B	Moisture Content Test of natural wood material only	
C	Coating Adhesion Test on Coating / Painting Component (if available)	2 Samples per SKU

Note: ### - Shall Refer to Most Updated Switching Rules of The Home Depot.

----- End of This Section -----

## 6. Defect Classification

Item code	Details	Defective Classification		
		Critical	Major	Minor
1	<b>Packaging Check</b>			
A	Appearance of master carton			
	• Damaged / deteriorative/wet		✓	
	• Open end is not sealed securely		✓	
	• Wrong flute direction of carton		✓	
B	Shipping mark			
	• For carton, shipping label and/or pallet/crate, shipping label less than requirement		✓	
	• Wrongly in content and format		✓	
C	Strapping method of master carton			
	• Wrong strapping method was used		✓	
D	Pack size			
	• The actual quantity does not match requirement of package		✓	
2	<b>Aesthetics / Appearance Check</b>			
A	Instruction (sheet)/warning/warranty			
	• Dirt / scratch / unclear / illegible / wrong / damaged / wrinkled/peeled/detached/smeared/displaced, will cause unsaleable, misunderstanding of reader, information missing etc.)		✓	
	• Dirt / scratch / unclear / illegible / wrong / damaged / wrinkled/peeled/detached/smeared/displaced, will not affect sales, although illegible but will not cause information incompleteness etc.)			✓
	• Misleading/incorrect descriptions/claims		✓	
	• Wrong label / Instruction used		✓	
	• Missing instruction/warning/warranty/label/marketing sheet (will cause safety issue)	✓		
	• Missing instruction/warning/warranty sheet/label/marketing (will not cause safety issue)		✓	
B	Appearance of unit			
	• Non functional sharp point and sharp edge (May injure customer)	✓		
	• Live insect/infestation	✓		
	• Knives, blades, needles and similar sharp foreign object contamination	✓		
	• Excessive/unpleasant odour		✓	
	• Wrong color or style or type		✓	
	• Poor coating obviously		✓	
	• Poor coating slightly			✓
	• Loose/poor connection between hook and frame		✓	

Item code	Details	Defective Classification		
		Critical	Major	Minor
	<ul style="list-style-type: none"> <li>Deformed, damaged, broken, cracked, rusty mark, dead knot</li> </ul>		✓	
	<ul style="list-style-type: none"> <li>Obvious scratched, dirty mark, chipped, glue mark</li> </ul>		✓	
	<ul style="list-style-type: none"> <li>Slight scratched, dirty mark, chipped, glue mark</li> </ul>			✓
	<ul style="list-style-type: none"> <li>Rough on surface</li> </ul>		✓	
	<ul style="list-style-type: none"> <li>Missing piece per set</li> </ul>		✓	
	<ul style="list-style-type: none"> <li>Rusted / Oxidation / corrosion on metal parts</li> </ul>		✓	
	<ul style="list-style-type: none"> <li>Screw / hooks loosen and causing some parts loosed</li> </ul>		✓	
	<ul style="list-style-type: none"> <li>Incorrect plating on metal part</li> </ul>		✓	
	<ul style="list-style-type: none"> <li>Any missing parts or wrong type parts</li> </ul>		✓	
	<ul style="list-style-type: none"> <li>Detached/ missing components</li> </ul>		✓	
	<ul style="list-style-type: none"> <li>Detached/ missing components</li> </ul>		✓	
	<ul style="list-style-type: none"> <li>Hard to adjust length</li> </ul>		✓	
C	Accessories			
	<ul style="list-style-type: none"> <li>Missing or incorrect accessories</li> </ul>		✓	
	<ul style="list-style-type: none"> <li>Mismatched accessory</li> </ul>		✓	
D	Unit packaging			
	<ul style="list-style-type: none"> <li>Dirt / dust /scratches / damage / deformation on labeling or packaging material that will affect selling</li> </ul>		✓	
	<ul style="list-style-type: none"> <li>Dirt / dust /scratches / damage / deformation on labeling or packaging material that will not affect selling</li> </ul>			✓
	<ul style="list-style-type: none"> <li>Insufficient protection to product that will cause product damage.</li> </ul>		✓	
	<ul style="list-style-type: none"> <li>Missing “Country of origin” or “Distributor or importer’s name and post address” marking or label (single unit)</li> </ul>		✓	
	<ul style="list-style-type: none"> <li>Missing “Country of origin” or “Distributor or importer’s name and post address” marking or label (whole lot of certain SKU)</li> </ul>	Fail the shipment		
	<ul style="list-style-type: none"> <li>Wrong size/style/color assortment within one retail unit</li> </ul>		✓	
3	<b>Bar Code Verification</b>			
	<ul style="list-style-type: none"> <li>Bar code can not be scanned</li> </ul>		✓	
	<ul style="list-style-type: none"> <li>Bar code label is damaged but still can be scanned</li> </ul>			✓
	<ul style="list-style-type: none"> <li>Two bar code labels at same panel of selling package and may lead to wrong payment by double scanning.</li> </ul>		✓	
	<ul style="list-style-type: none"> <li>Wrong bar code label is used (single unit)</li> </ul>		✓	
	<ul style="list-style-type: none"> <li>Wrong bar code label is used (whole lot of certain SKU)</li> </ul>	Fail the shipment		
	<ul style="list-style-type: none"> <li>Bar code No. on unit does not match PO list</li> </ul>		✓	
4	<b>Data Measurement and Test</b>			
A	Size and weight of unit			
	<ul style="list-style-type: none"> <li>Measured data is out of tolerance</li> </ul>		✓	
B	Moisture Content Test of natural wood material only			

Item code	Details	Defective Classification		
		Critical	Major	Minor
	<ul style="list-style-type: none"> <li>Moisture content exceeds the standard</li> </ul>		✓	
C	Coating Adhesion Test on Coating / Painting Component (if available)			
	<ul style="list-style-type: none"> <li>Removal of coating is equal or more than 15% after Cross Hatching Test or / and</li> <li>Specimen falls down after Tape test.</li> </ul>	Reject the shipment		

**Note 1: The above described defects are those most commonly found, but not necessarily cover all possible defects. And the defective classification is for reference only. The final decision of the defective classification would be decided by the inspector.**

**Note 2: The checking and defect finding evaluation should be conducted at a distance around 76 cm (when an adult extends his hand forward, normally it is distance from eye to tip of middle finger), the time duration for one position is around 3-5 seconds.**

----- End of This Section -----

## 7. Revision History

DATE	REVISION	REVISED BY	APPROVED BY
Dec 20, 2012	Draft IR	Ada Liang	Nancy Du
Dec 20, 2012	V00, Initial Released	Ada Liang	Nancy Du
Dec 24, 2012	V01, 1)Updated the qty to 2 on page 3; 2) Updated the unit package size on page 5; 3) Updated the package specification on page 7 as per customer comments.	Sally Fan	Nancy Du
Dec 24, 2012	V02, 1) Updated the tolerance on page 3; 2) Added all related information for the moisture content test; 3) Added the Finger joints & Pole curvature degree control test on page 23; 4) Added the components' net weight on page 12.	Sally Fan	Nancy Du
Dec 25, 2012	V03, Per ECN 15756, Add hang tab function.	Sally Fan	Nancy Du
Dec 25, 2012	V04, Per ECN 15751 & 15752, Add hang tab function.	Sally Fan	Nancy Du
Dec 27, 2012	V05, Updated the product weight for model#33-BS-1/33-BS-2/33-BS-4/33-BD-1/33-BD-2/33-BD-4 as per customer comments.	Sally Fan	Nancy Du
Feb 28, 2013	V06, Per ECN 16012, Updated the smaller hole to the groove.	Sally Fan	Nancy Du
Mar 29, 2013	V07, Per ECN 16593, Electroplating layer color change from trivalent blue zinc to trivalent black zinc.	Sally Fan	Nancy Du
May 09, 2013	V08, Add one more sticker inside packaging per ECN 16895.	Aleena Feng	Nancy Du
Jun 05, 2013	V09, Updated the product photos per vendor's request.	Aleena Feng	Nancy Du
Aug 21, 2014	V10, Per ECN 21914, changed metal plate, wall anchor, screw and instruction manual.	Sally Liu	Nancy Du
Jan 14,2016	V11, Per ECR-1483, 1. Revise step 2A change the pilot hole from 3/16 inch to 1/8 inch; 2. Revise step 2B specify how the drywall anchors are to be installed. The requested implementation date is 04/01/2016.	Cathy Chen	Dylan Zhao

### Additional tests

- 1. Finger joints: for 6' poles within 2 finger joints; for 8' poles within 3 finger points. No obvious joint mark and color aberration.**
- 2. Pole curvature degree control: 6' poles within 5mm, 8' poles within 7mm.**