

## PRESSURE WASHER LIMITED WARRANTY

This product is under warranty to the original retail consumer against defects in material and workmanship for a period of 1 (one) year on machine, 90 days on gun and hose assembly, from the date of retail purchase and is not transferable. Warranty covers replacement parts. This limited one year warranty applies only to products used in consumer applications and does not apply to rental or commercial applications. Use reasonable care in the operation and maintenance of the pressure washer as described in the owner's manual.

### WARRANTY RETURNS

Items returned for warranty consideration must have a Returned Merchandise Authorization (RMA) number and proof of purchase. All unauthorized returns will be refused and shipped back to sender. Freight costs, if any, must be paid by the purchaser. Call 1-866-235-5112 Monday through Friday 8:00 a.m. - 5:00 p.m. (Central Standard Time). Or E-Mail to: info@arnorthamerica.com 24 hours a day.

### A.R. North America, Inc.

Attn: Pressure Washer Warranty Department  
140 - 81st Avenue NE, Fridley, MN 55432

www.arnorthamerica.com

*Please read and save these instructions. Read carefully before attempting to assemble, install, operate or maintain the product described. Protect yourself and others by observing all safety information. Failure to comply with instructions could result in personal injury and/or property damage! Retain instructions for future reference.*

## Electric Pressure Washer

### Specifications:

MODEL	MAX PSI	MAX GPM	MAX TEMP	VOLTAGE	AMPS	UNIT WEIGHT
AR112	1600	1.58	122°F	120V	11	18 lbs



### SAFETY GUIDELINES:

This manual contains information that is very important to know and understand. This information is provided for SAFETY and to PREVENT EQUIPMENT PROBLEMS. To help recognize this information, observe the following symbols.

#### ▲WARNING

*Warning indicates a potentially hazardous situation which, if not avoided, COULD result in death or serious injury.*

#### ▲CAUTION

*Caution indicates a potentially hazardous situation which, if not avoided, MAY result in minor or moderate injury.*

**NOTE or NOTICE:** Information that requires special attention.

### IMPORTANT

This pressure washer is equipped with a microswitch sensitive to water flow. This Total Stop System (TSS) senses water flow in the pump. When the trigger is released, water stops flowing through the pump. The TSS then automatically turns the motor off to protect the pump from overheating.





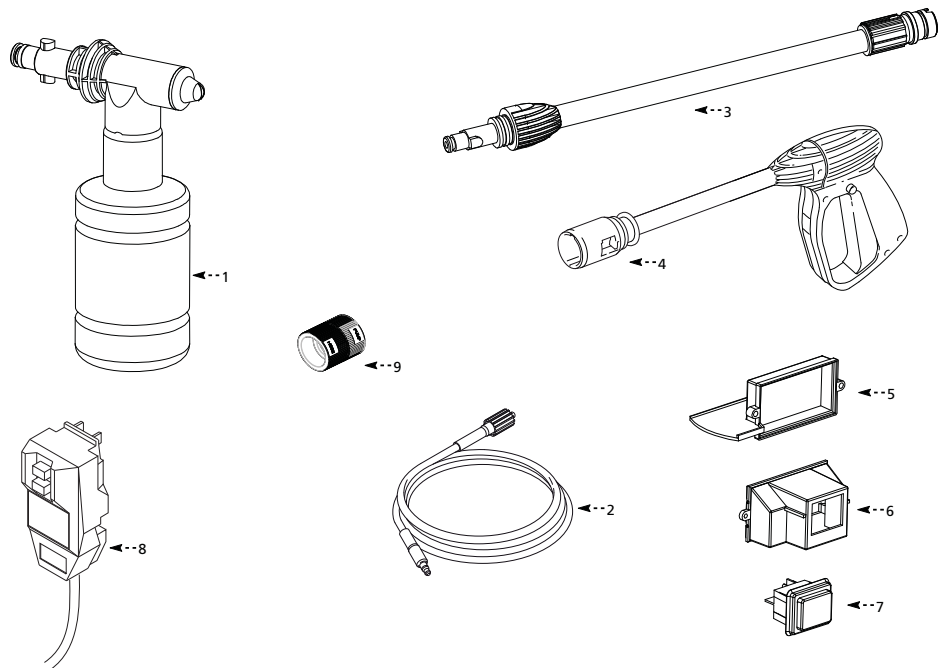

Pos.	Description	Part Number	Qty.
1	Detergent Tank	AR50954	1
2	High Pressure Hose	AR3082290	1
3	Adjustable Lance/Nozzle	AR50955	1
4	Gun	AR3082280	1
5	Waterproof Cover	AR50949	1
6	Switch Box	AR50946	1
7	Switch	AR50945	1
8	Electric Cord w/GFCI	DX2731301100	1
9	Garden Hose Fitting (with filter)	BQ09010305	1

Pump Spare Part Kits

Water Seals & Valves	AR3081290
Pre-Assembly TSS	AR3082350

**OPERATION**

1. Pull trigger on gun.
2. Turn the "ON/OFF" switch to "ON".
3. Release trigger. The pressure washer motor will stop running.
4. To spray again, pull trigger and motor and pump will restart.

Note: Occasionally the motor may run for a short time to bring fresh, cool water into the pump even if the trigger is released. This is part of normal operation and will not damage the unit.

**CAUTION** Always turn the "ON/OFF" switch to "OFF" then trigger gun to release hose pressure before unplugging the power cord.

**CAUTION** Risk of equipment damage. Always make sure the "ON/OFF" switch on the unit is "OFF" and unit is unplugged prior to storage.

**WARNING** Risk of Injection. Unit will start spraying when trigger is squeezed if "ON/OFF" switch is in "ON" position. Always point gun in a safe direction.

**IMPORTANT SAFETY INSTRUCTIONS**

*Save These Instructions*

**WARNING**  
When using this product, basic precautions should always be followed, including the following:

1. Read all instructions before

using the product.

2. Always disconnect power before disassembling or repairing the unit.
3. Follow all safety codes as well as the Occupational Safety and Health Act (OSHA).
4. Ensure safety devices are operating properly before each use. DO NOT remove or modify any part of the gun or unit.
5. Know how to stop this product and bleed pressure quickly. Be thoroughly familiar with the controls.
6. Stay alert - watch what you are doing.
7. Do not operate the product when fatigued or under the influence of alcohol or drugs.
8. Keep operation area clear of all persons.
9. Do not overreach or stand on unstable support. Keep good footing and balance at all times.
10. Follow the maintenance instructions specified in the manual.
11. This product is provided with a ground fault circuit interrupter, GFCI, be sure to inspect cord and GFCI prior to use. Any repair or replacement of the power cord must be performed by a qualified (licensed or certified) electrical technician.
12. Never use an extension cord with this product.
13. The power cord on this product contains chemicals, including lead, known to the State of California to cause [cancer and] birth defects or other reproductive harm. Wash hands after handling.

**IMPORTANT SAFETY INSTRUCTIONS (CONT)**

14. To reduce the risk of injury, close supervision is necessary when a product is used near children.

**▲WARNING****Risk of Electrocutation**

- Inspect cord before using - Do not use if cord is damaged.
- Keep all electrical connections dry and off the ground.
- Do not touch plug with wet hands.
- This product is provided with a ground fault circuit interrupter built into the power cord plug. If replacement of the plug or cord is needed, use only identical replacement parts.
- Do not spray electrical apparatus and wiring.

**▲WARNING****Risk of Injection or Severe Injury**

- High pressure. Keep clear of nozzle. Do not discharge streams at persons or animals.
- Never put hand or fingers over spray tip while operating the unit.
- Never try to stop or deflect leaks with any body part.
- Always engage the trigger safety latch in the safe position when spraying is stopped even if only for a few moments.
- Point gun in safe direction. Unit will start spraying when trigger is squeezed if 'on/off' switch is in "ON" position.
- Discharge pressure - When 'on/off' switch is in "OFF" position,

pressure may still exist in unit. To discharge pressure, point gun in safe direction and squeeze trigger.

**▲WARNING****Risk of Explosion**

- Do not spray flammable liquids.
- Never use in areas containing combustible dust, liquids, or vapors.

**▲CAUTION**

- High pressure - Gun kicks back - Hold gun with both hands.
- Keep hose away from sharp objects. Bursting hoses may cause injury. Examine hose regularly and replace if damaged. Do not attempt to mend a damaged hose.

**NOTE**

- Use only detergents specifically formulated for pressure washers. Always follow detergent manufacturer's label recommendations for proper use of detergents. Always protect eyes, skin, and respiratory system from detergent.
- For either indoor or outdoor use. Store indoors and where temperature stays above freezing.
- Unplug unit when not in use.
- Pressure washer is not meant to pump hot water. Do not connect to hot water supply.
- Never leave the unit unattended while it is plugged in.
- Always turn water supply "ON" before turning pressure washer

**END OF OPERATION**

1. Press the ON/OFF switch to "OFF" on the pressure washer.
2. Disconnect the plug from the power source.
3. Shut off the water supply.
4. Activate the spray handle to relieve the machine of pressure.
5. Lock the trigger into the "OFF" position.

**OPERATION**

High pressure rinsing should also progress from the bottom to top. On particularly tough stains, it may be necessary to use a brush in combination with detergents and high pressure rinsing.

1. The lance is affected by pressure during operation; therefore hold it firmly with both hands and point the nozzle toward the ground.
2. Activate by pulling the trigger of the gun/spray handle.
3. Adjust the distance to the cleaning surface, which will also adjust your pressure of the nozzle.
4. Spray pattern shape and intensity can be changed by twisting the spray adjuster at the end of the lance. Keep hands clear of the front of the lance to prevent injury.

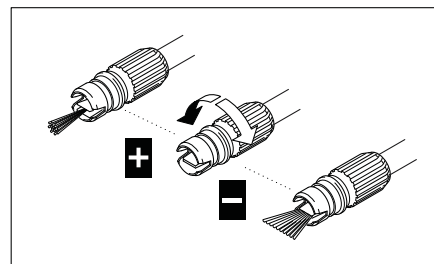

**CLEANING  
INSTRUCTIONS (CONT)**

- Vary the fan pattern spray angle and the distance to the cleaning surface until optimum cleaning efficiency is achieved without damaging the surface.

A clogged or partially clogged nozzle can cause a significant reduction of water coming out of the nozzle and cause the unit to pulsate while spraying.

**NOZZLE CLEANING INSTRUCTIONS**

To clean out the nozzle:

- Turn off the unit.
- Turn off the water supply. Relieve any pressure trapped in the hose by squeezing the trigger 2 - 3 times.
- Separate lance from gun.
- Rotate nozzle to the narrow stream setting. This opens up the fan blades.
- Using the included tip cleaner, or an un-folded paper clip, insert wire into the nozzle hole and move back and forth until debris is dislodged.

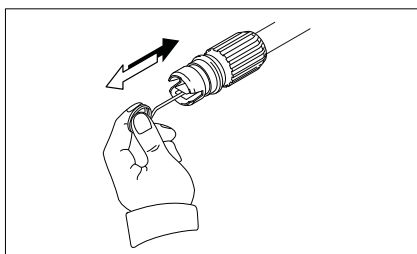

- Remove additional debris by back-flushing water through the nozzle. To do this, remove the lance from the gun, place

end of a garden hose (with water running) to tip of nozzle pushing water and debris out the back opening of the lance.

**DETERGENTS**

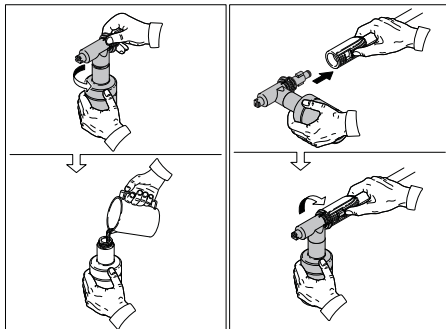

The use of detergents can dramatically reduce cleaning time and assist in the removal of difficult stains. Some detergents have been customized for pressure washer use on specific cleaning tasks. These detergents are approximately as thick as water. The use of thicker detergents, such as dish soap, will clog the chemical injection system and prevent the application of the detergent.

The cleaning power of detergents comes from applying them to a surface and giving the chemicals time to break down the dirt and grime. Detergents work best when applied at low pressure.

The combination of chemical action and high pressure rinsing is very effective. On vertical surfaces, apply the detergent starting at the bottom and working your way upward. This will prevent the detergent from sliding down and causing streaks.

“ON”. Running pump dry causes damage.

**SERVICING OF A DOUBLE-INSULATED APPLIANCE**

In a double-insulated product, two systems of insulation are provided instead of grounding. No grounding means are provided for a double-insulated product, nor should grounding means be added to the product.

Servicing a double-insulated product requires extreme care and knowledge of the system, and should be done only by qualified service personnel.

Replacement parts for a double-insulated product must be identical to the original parts. A double-insulated product is marked with the words “Double Insulation” or “Double Insulated”. Product may also be marked with symbol shown below.

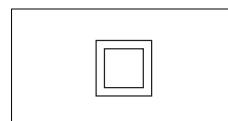

**⚠ WARNING** *Do not use pressure that exceeds the operating pressure of any of the parts (hoses, fittings, etc.) in the pressurized system. Ensure all equipment and accessories are rated to withstand the maximum working pressure of the unit.*

**⚠ WARNING** *Do not spray electrical apparatus and wiring.*

- Never disconnect the high pressure discharge hose from the machine while the system is pressurized. To depressurize machine, turn power and water supply off, then press gun trigger 2 - 3 times.
- Never permanently engage the trigger mechanism on the gun.
- Never operate the machine without all components properly connected to the machine (handle, gun/wand assembly, nozzle, etc.).

**⚠ WARNING** *Equipment damage.*

- ALWAYS turn water supply “ON” before turning pressure washer “ON”. Running pump dry causes serious damage.
- Do not operate the pressure washer with the inlet water screen removed. Keep screen clear of debris and sediment.
- NEVER operate pressure washer with broken or missing parts. Check equipment regularly and repair or replace worn or damaged parts immediately.
- Use only the nozzle supplied with this machine.
- Never leave the wand unattended while the machine is running.
- Never attempt to alter factory settings. Altering factory settings could damage the unit and will void the warranty.
- Always hold gun and wand firmly when starting and operating the machine.

**SERVICING OF A DOUBLE-INSULATED APPLIANCE (CONT)**

- NEVER allow the unit to run with the trigger release (off) for more than one (1) minute. Resulting heat buildup will damage pump.
- Pressure washer is not meant to pump hot water. NEVER connect it to a hot water supply as it will significantly reduce the life of the pump.
- NEVER store the pressure washer outdoors or where it could freeze. The pump will be seriously damaged.
- Release trigger when changing from high to low pressure modes. Failure to do so could result in damage.

2. Attach garden hose to swivel adapter side marked hose.

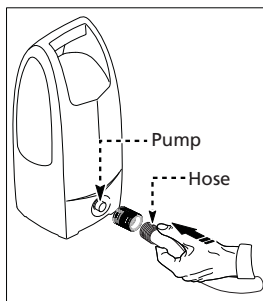

3. The spray gun should be locked into the "OFF" position by locating the safety trigger lock just above the trigger of the gun. Activate the lock by holding the gun and push the lock from left to right. Squeeze trigger to make sure the trigger does not move. The safety trigger lock should be locked at all times when pressure washer is not in use.

**POWER CORD**

1. Plug the power cord into a grounded 120V outlet and press the reset button as shown below.
2. THIS MUST BE DONE EACH TIME THE UNIT IS PLUGGED IN AN OUTLET.

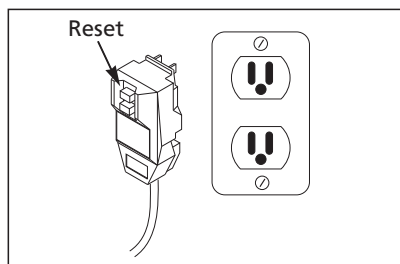

**CAUTION** Keep hose away from sharp objects. Bursting hoses may cause injury. Examine hoses regularly and replace if damaged. Do not attempt to mend a damaged hose.

**GARDEN HOSE CONNECTION INSTRUCTIONS**

1. Attach swivel adapter to pump water inlet, if not already attached. Notice the swivel adapter is marked with the words pump and hose. Make sure to connect pump side of the adapter to the pump water inlet to prevent damage to the threads.

**SYSTEM CONNECTION**

1. Insert lance adapter into the gun and turn clockwise to positive stop as shown below.

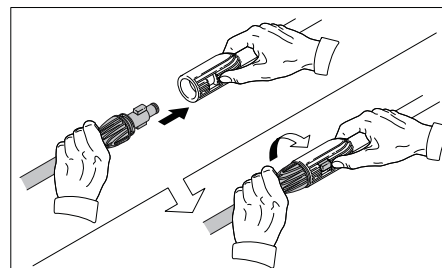

2. Insert detergent bottle assembly into lance, push down and turn clockwise to a positive stop.
3. Be sure that the power switch is in the "OFF" position.
4. Attach the high pressure hose onto the pump water outlet by turning clockwise and hand tightening.
5. Connect garden hose as explained under Garden Hose Connection Instructions.

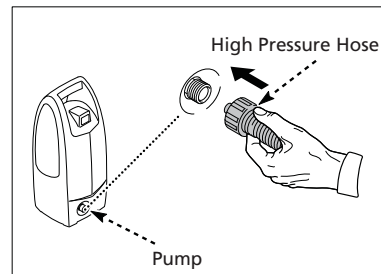

6. Plug the power cord into a grounded 120V outlet.
7. Turn water on.
8. Unlock trigger lock by moving lock right to left.

9. Depress and hold the trigger on the gun for one minute to release pressure and remove any air trapped in the system.
10. Turn the "ON/OFF" switch to the "ON" position.

**HOW TO AVOID DAMAGING SURFACES**

**DIRECTIONS FOR USE**

Damage to cleaning surfaces occurs because the impact force of the water exceeds the durability of the surface. You can vary the impact force by controlling the nozzle's fan pattern, the nozzle's angle to the cleaning surface, and the nozzle's distance from the cleaning surface. Never use a narrow high impact stream or a turbo nozzle on a surface that is susceptible to damage. Avoid spraying windows with a narrow high impact stream or turbo nozzle. Doing so may break the window. The surest way to avoid damaging surfaces is to follow these steps.

**CLEANING INSTRUCTIONS**

1. Before triggering the gun, adjust the nozzle to a wide fan pattern.
2. Place the nozzle approximately 4 - 5 feet away from the cleaning surface. Then hold the nozzle at a 45° angle to the cleaning surface. Trigger the gun.