

# Home Decorators

— Collection —

BF-22727 OXFORD COLLECTION 6 DOORS CABINET





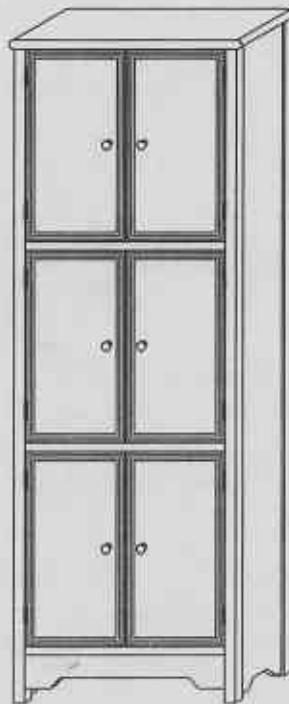

## ASSEMBLY INSTRUCTIONS

Made In China

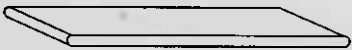
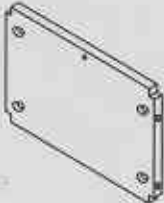
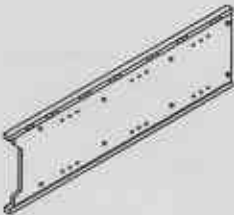
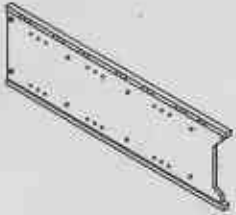
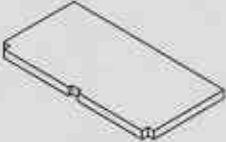
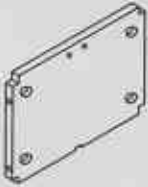

Thank you for purchasing this quality product. Be sure to check all packaging material carefully for small parts, which may have loose inside the carton during shipment. Once unpacked, compare all parts and hardware to the provided list to be sure all parts are present. If any parts or hardware are missing or damaged, please phone, e-mail or fax our Customer service Department. For speedy service, please provide your order number, item number and part number/letter of the part needed.

IMPORTANT NOTE: Follow instructions listed below in proper sequence as numbered to assure fast, easy and correct assembly.

PARTS LIST		
<p>A</p>  <p>TOP PANEL-1PC</p>	<p>B</p>  <p>BOTTOM PANEL-1PC</p>	<p>C</p>  <p>LEFT SIDE PANEL-1PC</p>
<p>D</p>  <p>RIGHT SIDE PANEL-1PC</p>	<p>E</p>  <p>SHELF-3PCS</p>	<p>F</p>  <p>ACROSS PANEL-2PCS</p>
<p>G</p>  <p>RIGHT DOORS-3PCS</p>	<p>H</p>  <p>LEFT DOORS-3PCS</p>	<p>I</p>  <p>BACK PANEL-2PCS</p>
<p>J</p>  <p>REAR PANEL GUIDE-1PC</p>	<p>K</p>  <p>LOW PANEL-1PC</p>	<p>L</p>  <p>DOWELS-4PCS</p>

M

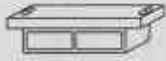

LARGE MAGNETS-3PCS

N

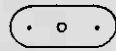

FEMALE MAGNETS-6PCS

O



SCREW-1PC

P



SCREWS-78PCS

Q



HINGES-12PCS

R



SCREWS-44PCS

S



SCREWS-4PCS

T



CAM-TOOL-1PC

U



SHELF SUPPORTS-12PCS

V



CAM-LOCKS-16PCS

W



CAM-BOLTS-16PCS

X



SCREWS-6PCS

Y



KNOB-6PCS

NOTE: • UPON OPENING THOROUGHLY CLEAN ALL WOODS SURFACES TO REMOVE DUST AND DIRT THAT MAY HAVE SETTLED ONTO FINISH DURING SHIPMENT. IN ORDER TO PREVENT DAMAGE DURING ASSEMBLY, PLEASE ASSEMBLE THIS ITEM WITH AT LEAST TWO PEOPLE.

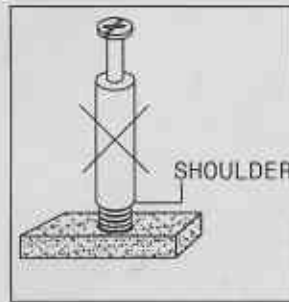
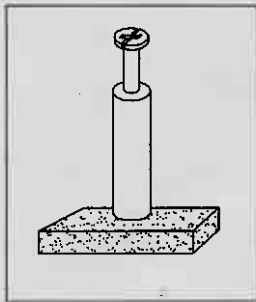

NOTE: TURN THE CAM-BOLT SCREWS UNTIL THEY ARE TIGHT, THE SHOULDER SHOULD BE AGAINST THE SURFACE OF THE PART.

## HOW TO USE THE CAM-TOOL

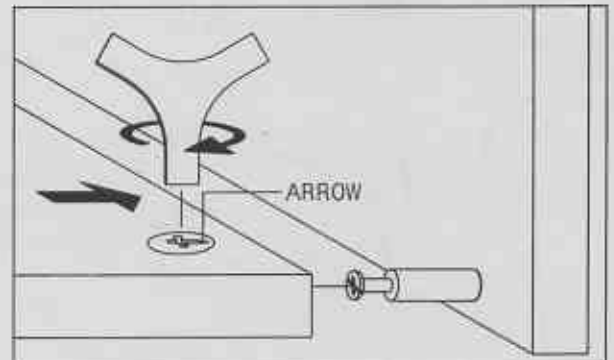
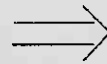
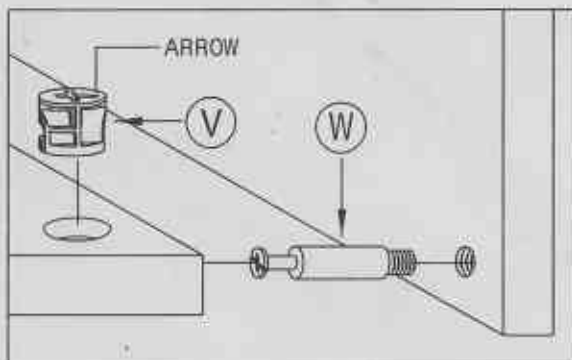

NOTE: • THE ARROWS ON THE HIDDEN CAM-LOCKS SHOULD POINT TO THE CAM-BOLTS

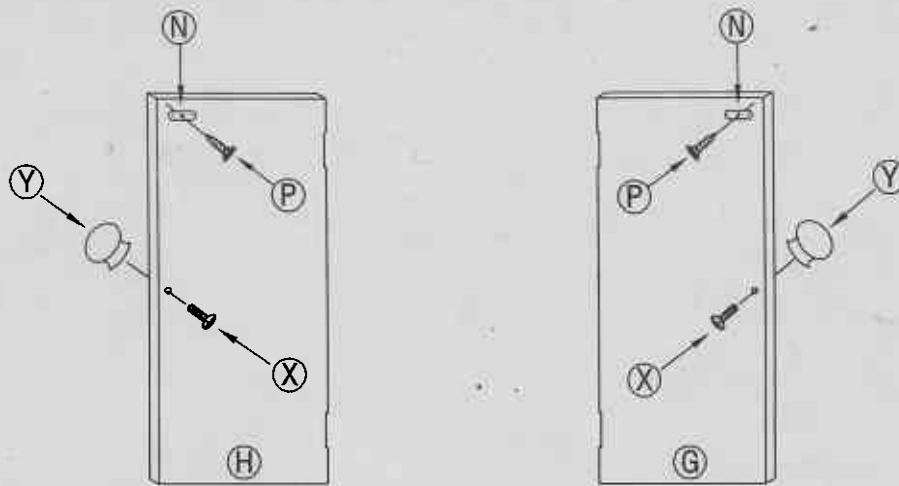

### 1) .ASSEMBLE THE DOORS(G/H) .

- ATTACH THE FEMALE MAGNET(N)TO DOORS(G/H)USING SCREWS(P) .
- ATTACH THE KNOB(Y)TO DOORS(G/H)USING SCREWS(X) .

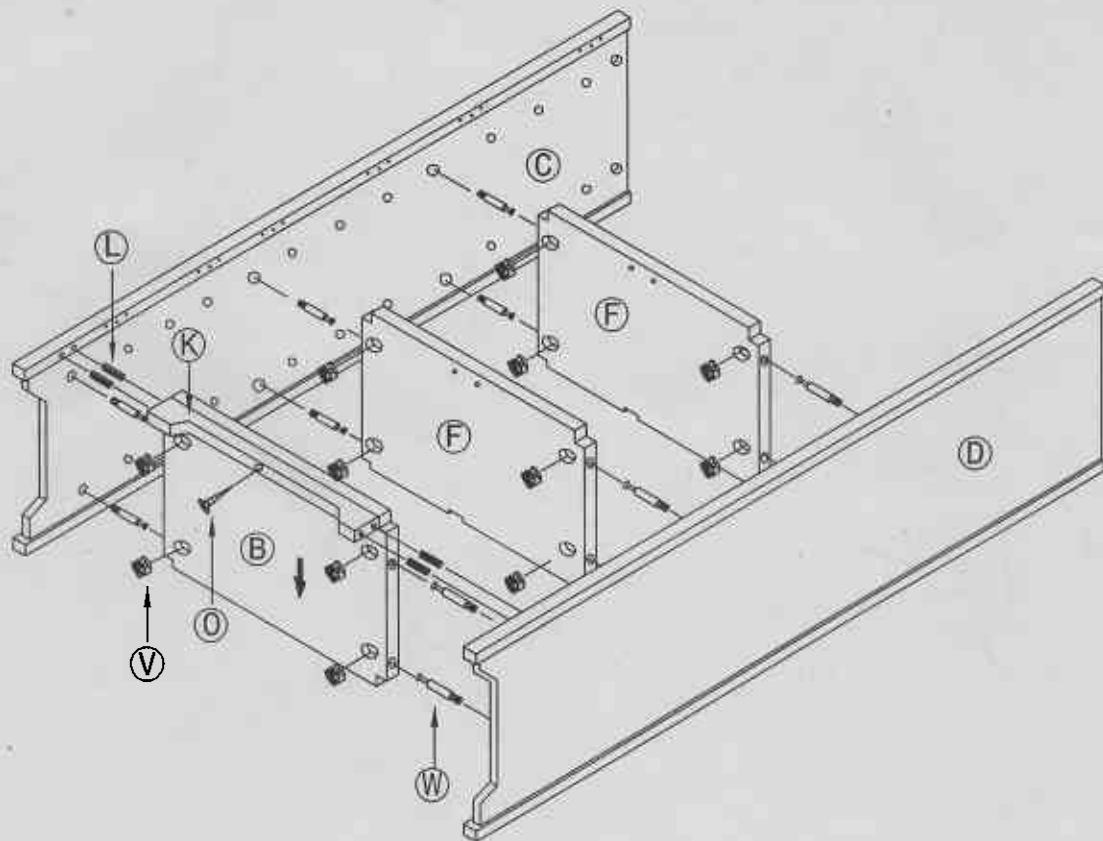

### 2) .ASSEMBLE THE SIDE PANEL(C/D) .

- ATTACH LOW PANEL(K)TO BOTTOM PANEL(B)USING SCREW(O) .
- INSERT THE 4 DOWELS(L)INTO HOLES IN LOW PANEL(K) .
- ROTATE THE CAM-BOLTS(W)INTO HOLES IN SIDE PANEL(C/D) .
- PLACE CAM-BOLTS(W)INTO HOLES IN PANEL(B/F)AND ATTACH USING 12 CAM-LOCKS(V) .

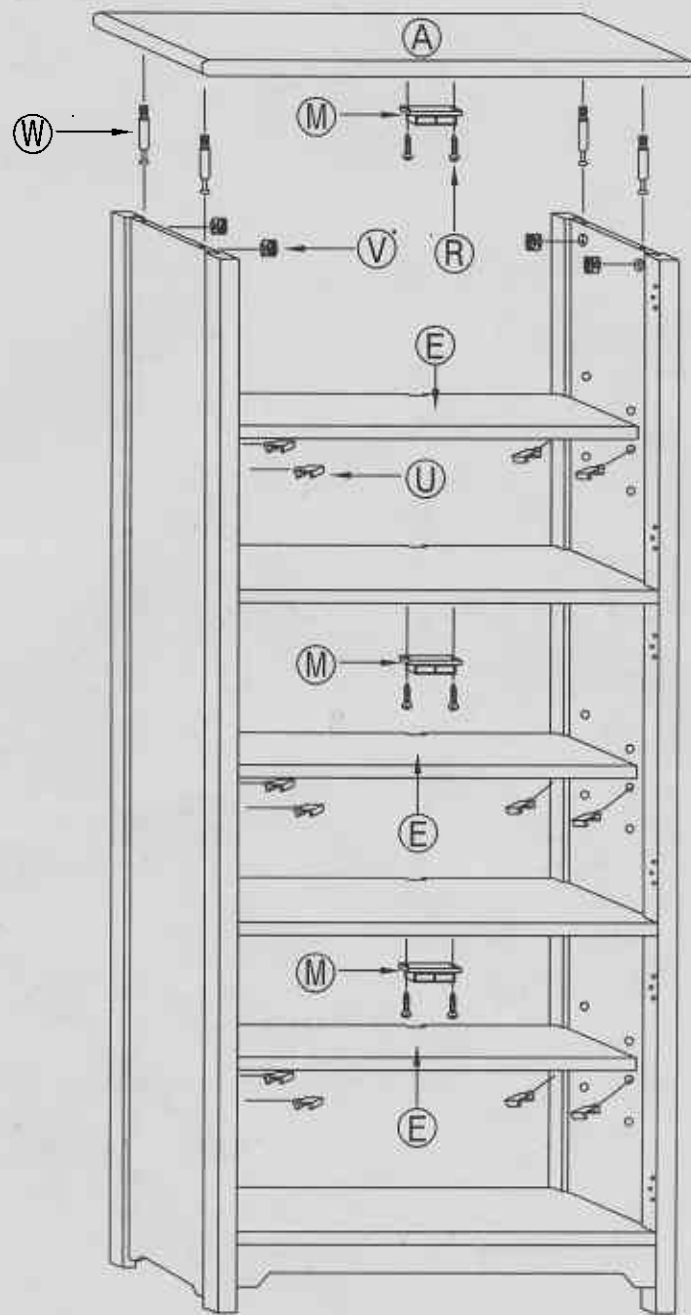

### 3) .ASSEMBLE THE TOP PANEL (A) .

- ATTACH LARGE MAGNETS(M) TO TOP/ACROSS PANEL (A/F) USING 6 SCREWS (R) .
- ROTATE THE CAM-BOLTS (W) INTO HOLES IN TOP PANEL (A) .
- PLACE CAM-BOLTS (W) INTO HOLES IN SIDE PANEL (C/D) AND ATTACH USING 4 CAM-LOCKS (V) .
- INSERT 12 SHELF SUPPORTS (U) INTO HOLES IN PANEL (C/D) AND PUT 3 SHELF (E) ONTO THEM .

NOTE: Attach the left door(H) by the same method as the right door(G) with screws and hinges.

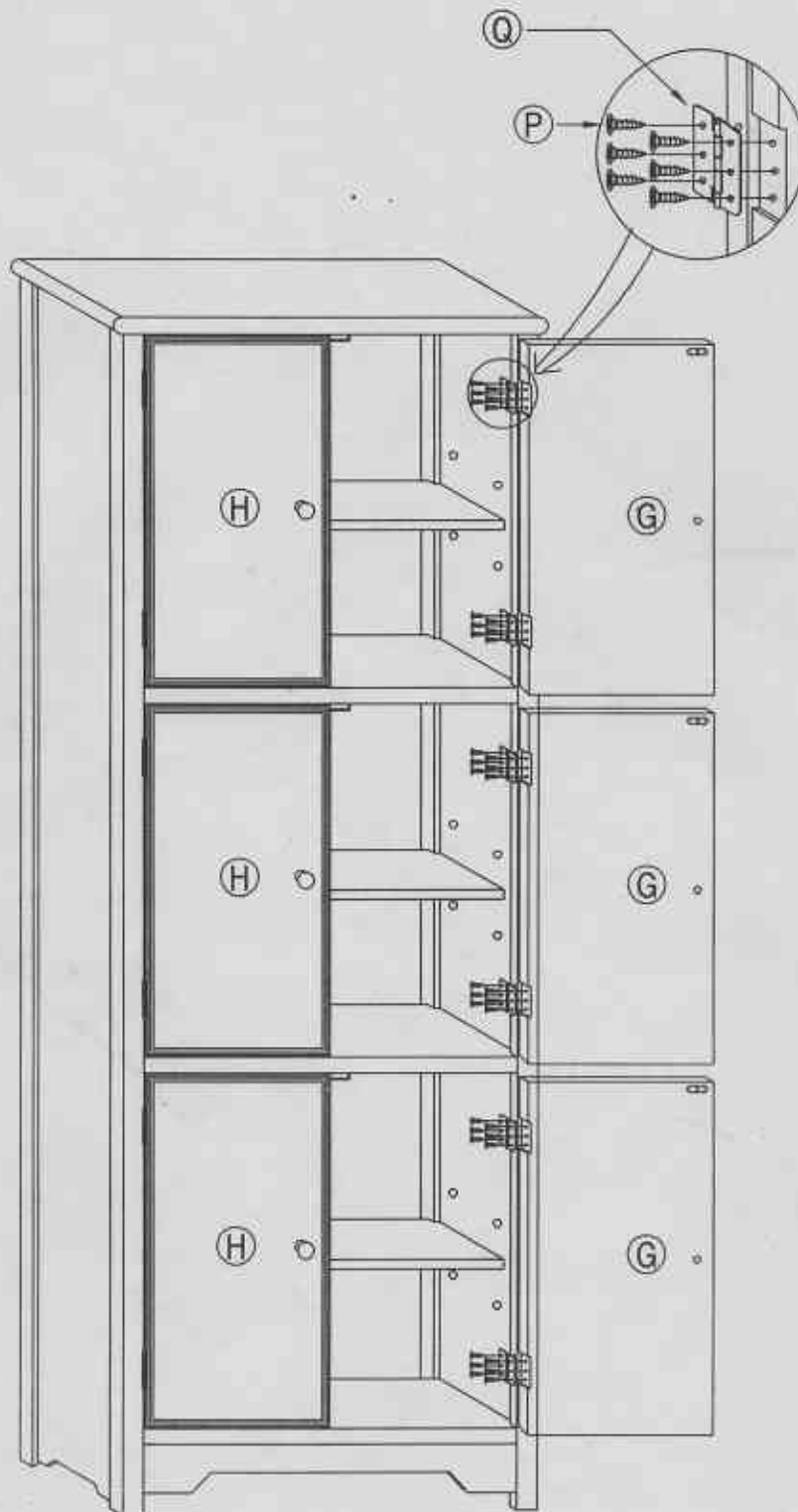

4) ASSEMBLE THE DOORS(G/H) .

- ATTACH 6 HINGES(Q) TO RIGHT DOORS(G) AND RIGHT SIDE PANEL(D) USING 36 SCREWS(P) .

Note: Before you assemble the back panel, please make sure the doors have an even gap around them. If uneven, shift the unit LEFT OR RIGHT UNTIL the doors are evenly spaced, then attach back panel.

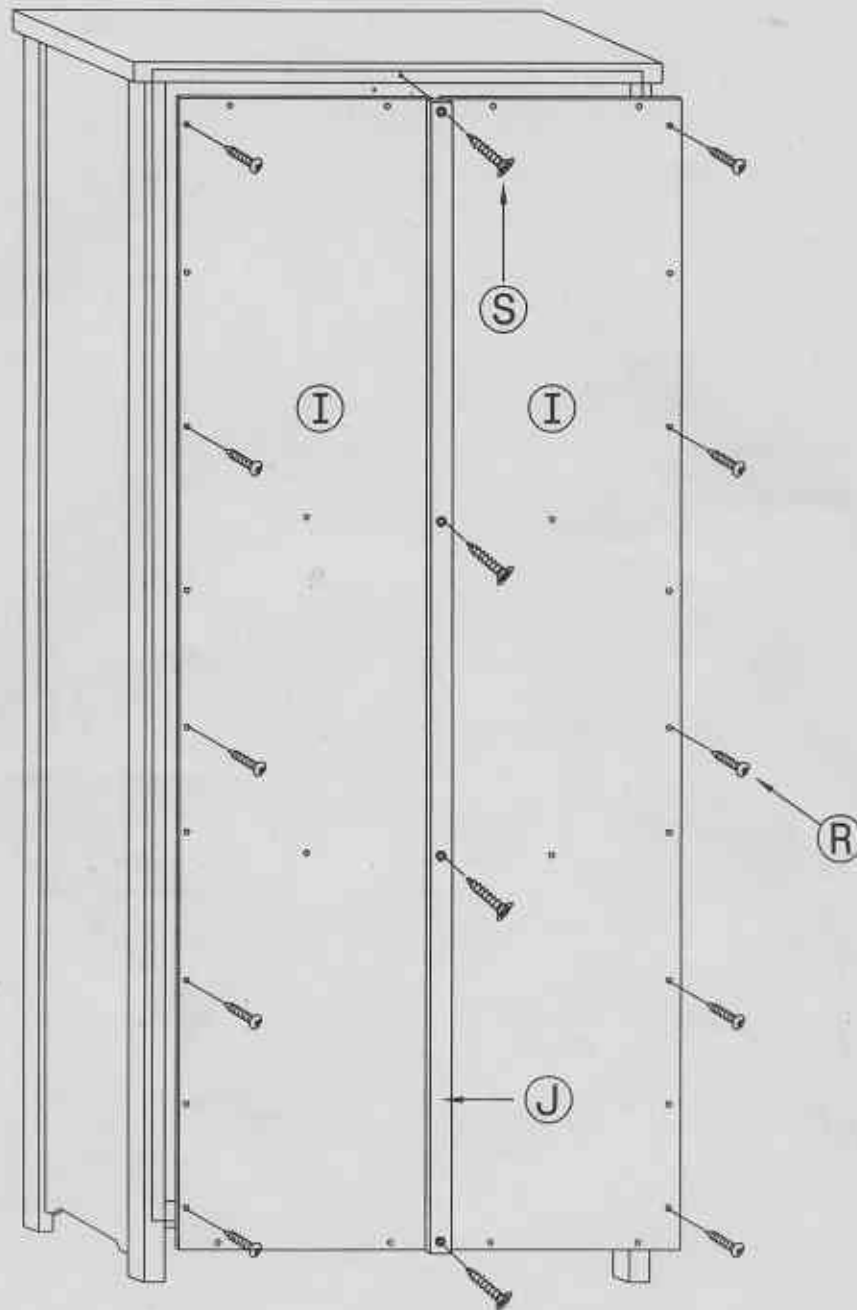

**5) .ASSEMBLE THE BACK PANEL (I) .**

- INSERT THE BACK PANEL (I) INTO SLOT IN REAR PANEL GUIDE (J) .
- ATTACH THE BACK PANEL (I) AND REAR PANEL GUIDE (J) USING SCREWS (R/S) .