

Necessaries Assembly Instructions ***Pub / Bistro Table***

Leave these instructions with property owner.

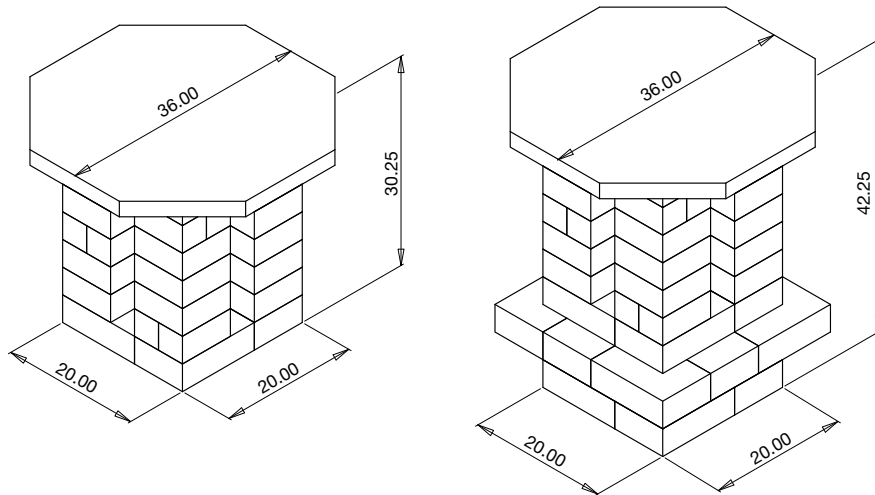

Buils either Pub Table or Bistro Table.

No cutting, no guessing, no hassles – no problem®

necessaries[™]
kits for outdoor living

ROCKWOOD[®]
RETAINING WALLS
A better way.™

Congratulations on choosing a "Necessories Kit." These superior-quality outdoor living kits have been designed to give you years of enjoyment and comfort.

IMPORTANT NOTICE: Read this entire Rockwood Retaining Walls, Inc. ("Rockwood") Limited Warranty and Limitation of Liability ("Limited Warranty"). While your Necessories Kit has been designed for ease of installation, it is important that it be properly installed and maintained in order for it to function successfully throughout the duration of this Limited Warranty. Your Necessories Kit comes packaged with assembly instructions. If you cannot locate the installation instructions, please contact us for another copy. It is also important for you or your installer to carefully review all pertinent technical information, as it is your responsibility or that of your installer or designer to provide any appropriate soil testing or soil preparation to insure a safe and functional application. Please visit www.rockwoodwalls.com for pertinent product information and installation guides.

LIMITED WARRANTY FOR NECESSORIES KITS

If you purchased a Necessories Kit and installed it in the United States, Rockwood warrants your Necessories Kit is free from defects in materials for a period of one year from the date we shipped the kit to the original purchaser. If Rockwood is given Prompt Notice, as defined in this Limited Warranty, it will replace the defective component at no cost to you. Replacement will consist of shipping the replacement component to your home or business. You are responsible for installing the replacement component. Kit components specifically addressed in the following paragraph also are subject to this limited one-year warranty against defects in materials. In some cases we may not be able to offer an identical replacement component. In these cases, we will supply a component of similar design and function. Natural components such as stone, block or brick may vary in color and texture and we cannot guarantee the replacement will match the color and texture of your original component.

COMPONENTS OF YOUR NECESSORIES KIT THAT ARE SUBJECT TO SEPARATE MANUFACTURER WARRANTIES

Your Necessories Kit consists of a number of superior-quality components from a number of our trusted partners and other quality manufacturers. Depending upon your particular Necessories Kit, these separately warranted components may include: (1) pre-cut block, (2) pavers, bricks and edgers, (3) mantles, tops and caps, (4) steel wood-burning inserts, chimneys and access doors, (5) grills, (6) water pumps, (7) steel spillways, (8) steel rings, cooking grates, spark screens and ring caps, (9) light kits, gas log sets, grill covers, cooking grates, and (10) glass kits and glass block. To the extent these fine components are covered by separate manufacturer warranties and we are able to transfer the applicable warranties to you, we do so by way of this Limited Warranty. However, some of the warranties applicable to the components of

your Kit may not be transferable, and, in which case, if we can make the claim on your behalf, we will do so if you follow the claim procedures set forth in this Limited Warranty. The extent of our obligation under this paragraph, however, is to make the warranty claim on your behalf to the extent that we can. It is up to the component manufacturer to respond under its warranty.

LIMITATION OF LIABILITY

This limited warranty sets forth the maximum liability for sale, distribution or use of your Necessories Kit. IN NO EVENT (INCLUDING WHERE THIS LIMITED WARRANTY IS DEEMED NOT TO APPLY TO THE SALE OF PRODUCT IN QUESTION) SHALL ROCKWOOD OR ANY OF ITS DISTRIBUTORS BE LIABLE FOR ANY INCIDENTAL, CONSEQUENTIAL, OR SPECIAL DAMAGES RESULTING FROM THE SALE, INSTALLATION OR USE OF YOUR NECESSORIES KIT. Some states do not allow the exclusion or limitation of incidental or consequential damages for consumers, so the above limitation or exclusion may not apply to you.

LIMITATION OF WARRANTY

ROCKWOOD MAKES NO OTHER WARRANTIES, EXPRESS OR IMPLIED, INCLUDING ANY IMPLIED WARRANTIES FOR MERCHANTABILITY, FITNESS FOR A PARTICULAR PURPOSE, OR OTHERWISE.

DISCLAIMER – WHAT THIS LIMITED WARRANTY DOES NOT COVER

Rockwood is not responsible for or makes no warranty as to:

1. Product failure, loss or damage due to:
 - Normal wear and tear;
 - Damage due to improper handling and repeated or extended contact with chemicals, such as deicers;
 - Products improperly installed or maintained;
 - Acts of God;
 - Structural settlement, movement or vibration;
 - Products that have not been paid for in full.
2. Minor imperfections
 - Minor imperfections that do not affect the product's structural integrity;
 - Variations in product texture or color.
 - Efflorescence;
 - Minor imperfections in shape, appearance, or dimensions covered by ASTM C1372.

CONDITIONS OF WARRANTY – WHAT YOU MUST DO TO RECOVER UNDER THIS LIMITED WARRANTY

Prompt Notice of Defect:

Within the warranty period, you must promptly, and in no case more than sixty (60) days after any

defect of other basis of a claim covered by this Limited Warranty is discovered or should have been discovered, notify Rockwood of the defect.

LIMITED WARRANTY CLAIM PROCEDURE

Claims under this Limited Warranty may be made in writing to Rockwood at 325 Alliance Place N.E., Rochester, MN, 55906. Claims should include the following information:

1. Claimant's name, address, and phone number and the installation address (if different);
2. A description of the product, purchase price, date and location of purchase, and copies of invoices, if available;
3. A description of the defect(s) (photos are required); and
4. A brief summary of attempts made to address the concerns.

NO STATEMENT OF USEFUL LIFE

This Limited Warranty is not a statement of the useful life of any Rockwood products.

COPYRIGHT NOTICE: The plans and instructions contained in this kit and the three-dimensional Pub/Bistro Table design constructed from the use of this kit are protected under the U.S. Copyright Act. Reproduction of the plans, instructions or the Pub/Bistro Table design, either in whole or in part, and whether in two-dimensional or three-dimensional form, and the creation of new works based upon such plans, instructions or Pub/Bistro Table design, without the prior written permission of Rockwood Retaining Walls, Inc. is strictly prohibited. The purchase of a genuine kit from Rockwood Retaining Walls, Inc. or an authorized Rockwood dealer provides the purchaser with a limited license to construct a single Pub/Bistro Table. Any reproduction of the plans and/or instructions, or the construction of more than a single Pub/Bistro Table is a violation of Rockwood's copyrights and can result in severe penalties.

U.S. Copyright Law allows for the recovery of statutory damages as well as attorneys fees. Damages for willful infringement can be as high as \$150,000. Further, it is not uncommon for attorneys fees to exceed the amount of damages awarded.

Manufactured under license by:



325 Alliance Place NE, Rochester, MN 55906
phone: 507.529.2871 • toll free: 888.288.4045
fax: 507.529.2879 • www.outdoorlivingkits.com



©2016 Rockwood Retaining Walls, Inc. All Rights Reserved. Made worldwide under license from Rockwood Retaining Walls, Inc. US and international patents issued and pending. This information has been prepared for the benefit of customers interested in Rockwood Retaining Wall products. It was reviewed carefully prior to publication. Rockwood assumes no liability for its accuracy or completeness. Final determination of the suitability of any information or material for the use contemplated, or for its manner of use, is the sole responsibility of the user. 816



WARNING: Failure to follow all steps of the installation instructions may result in property damage or bodily injury. Rockwood Retaining Walls, Inc. is not liable for any property damage or bodily injury caused by failure to follow the installation instructions or improper use of the product.

Pub/Bistro Table Kit Contents:

Item	Description	Quantity
Large Block	4" H x 8" W x 12" D (L)	23
Medium Block	4" H x 8" W x 8" D (M)	18
Small Block	4" H x 8" W x 4" D (S)	18
Cap - Top	36" W x 36" D	1
Adhesive	29 oz. Tubes	1

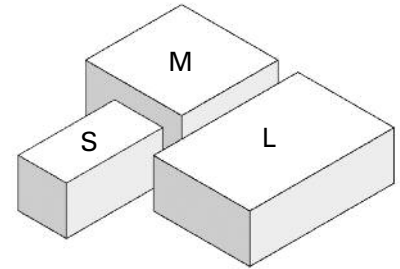

Preparation:

Base can be constructed of either poured slab or compacted gravel.

Concrete Base Foundation:

- 4" deep
- 4" outside perimeter of base
- Reinforce with 6" x 6" no. 10 WWM
- Compact sub-base soils to 95% of standard proctor (ASTM D698)

Aggregate Base Foundation:

- 6" deep
- 8" outside perimeter of base
- Compact sub-base soils to 95% of standard proctor
- Compact aggregate base to 95% of standard proctor (ASTM D698)

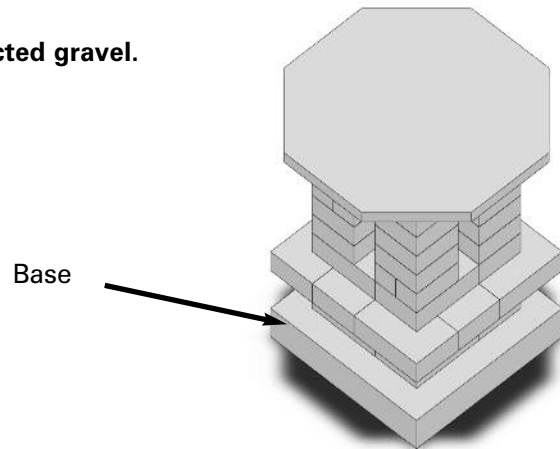

Zoning and Permits: Before you plan your project, learn about the necessary zoning requirements and rules for excavating and building in your area. No matter how small your project, be sure you obtain the necessary permits before you start construction.

Know What's Below: Whether you are planning to do it yourself or hire a professional, smart digging means calling 811 before each job. Homeowners often make risky assumptions about whether or not they should get their utility lines marked, but every digging job requires a call – even small projects like planting trees and shrubs.



Course 1 (Pub Table)

To build Bistro Table, see page 11.

Be sure your properly prepared base is level. Begin building by laying your base course as shown.

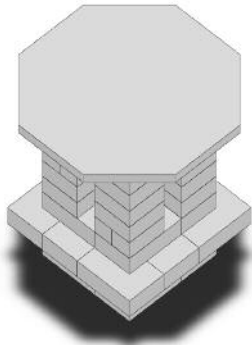

IMPORTANT: Lay glue bead away from outside perimeter to prevent glue from squeezing out between courses

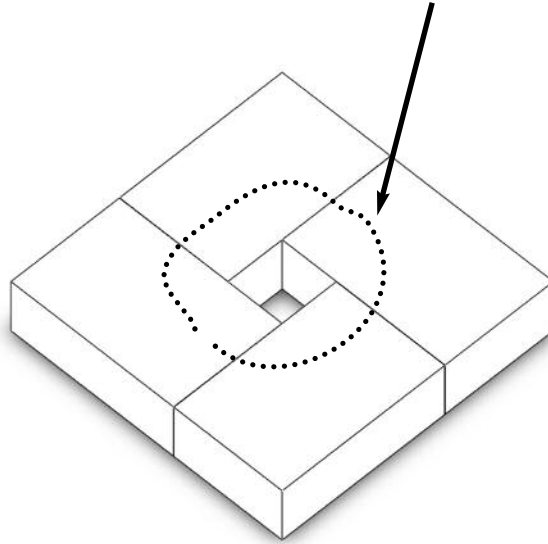

Course 2 (Pub Table)

Continue to build each course as shown. Use adhesive on each block.

IMPORTANT: Use adhesive on each course. Brush excessive dust from blocks to be glued.

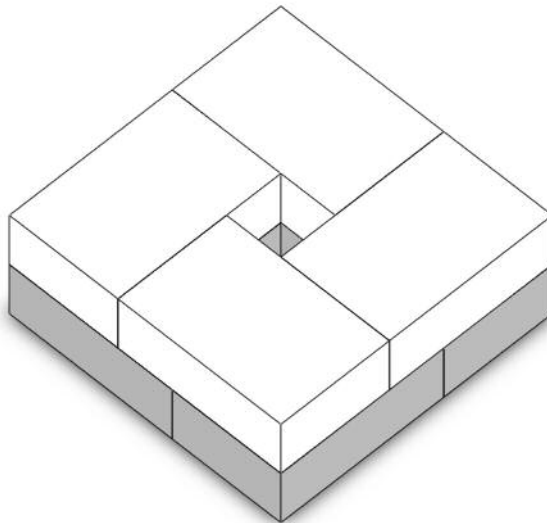

Course 3 (*Pub Table*)

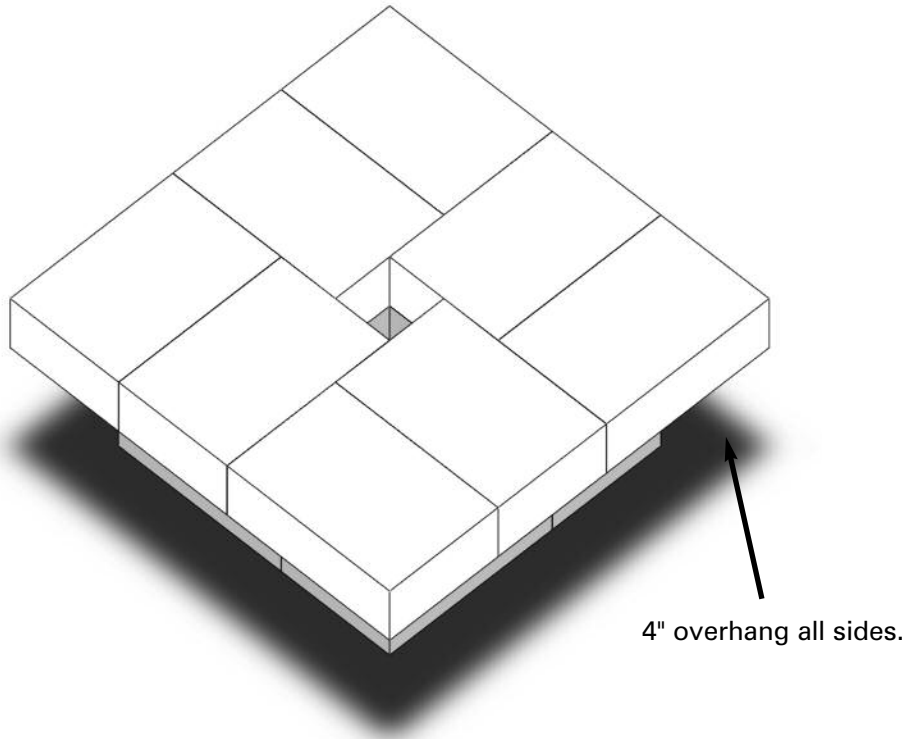

Course 4 (*Pub Table*)

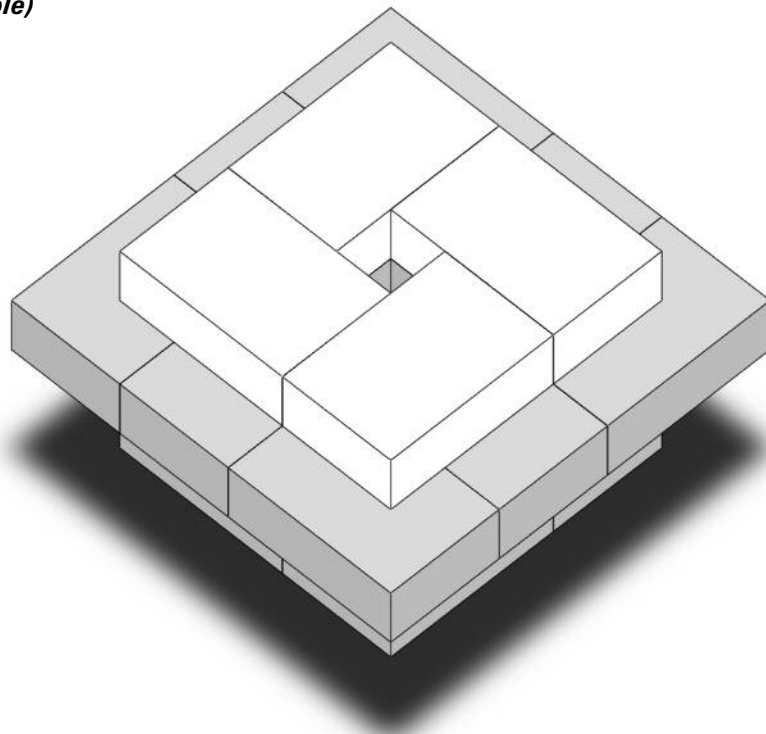

Course 5 (Pub Table)

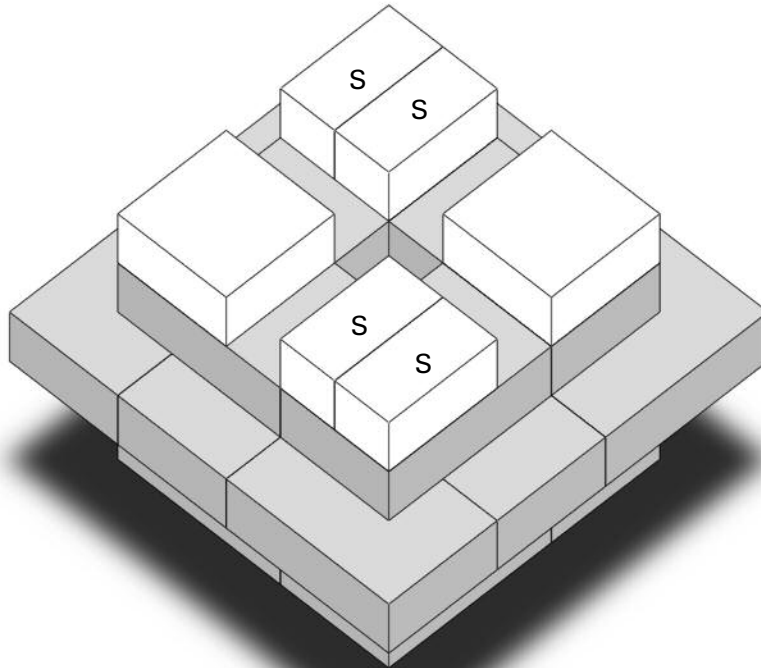

Course 6 (Pub Table)

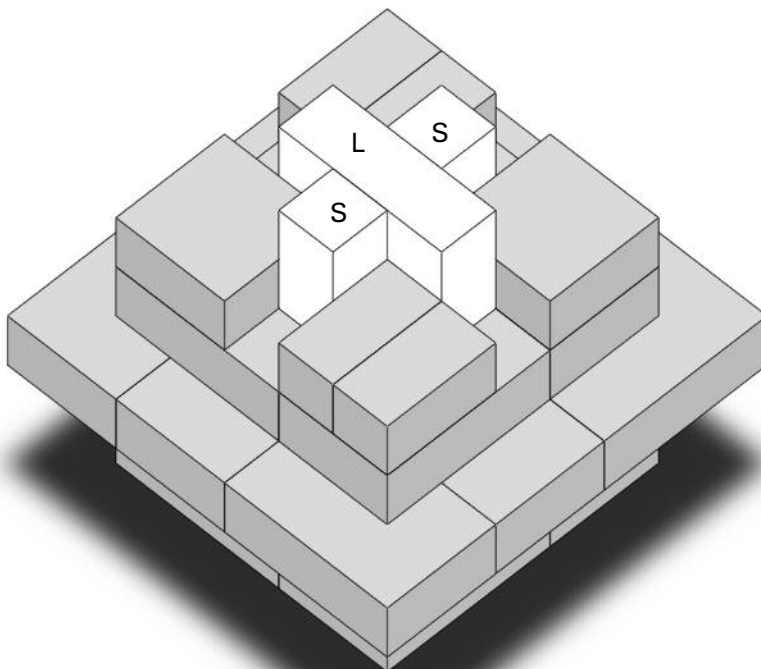

Course 7 (Pub Table)

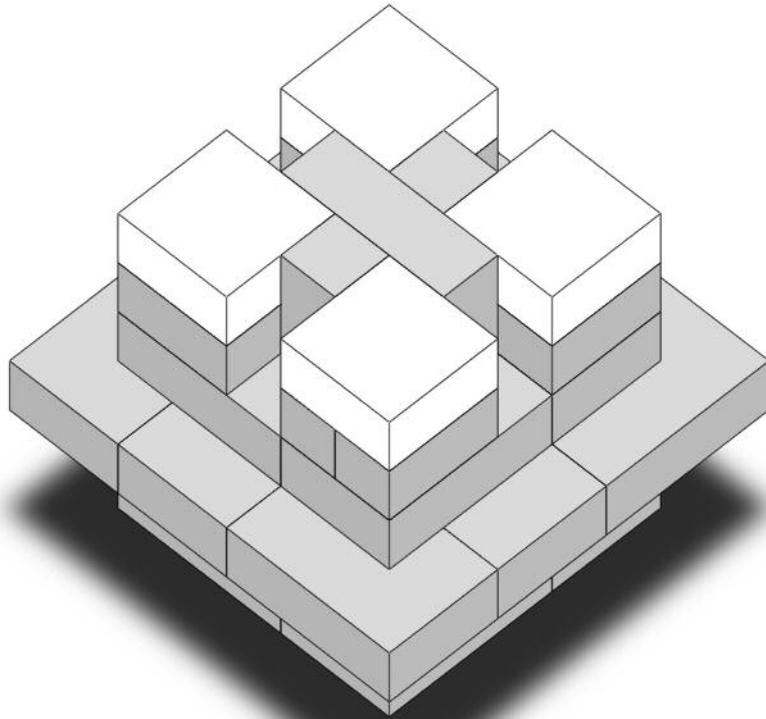

Course 8 (Pub Table)

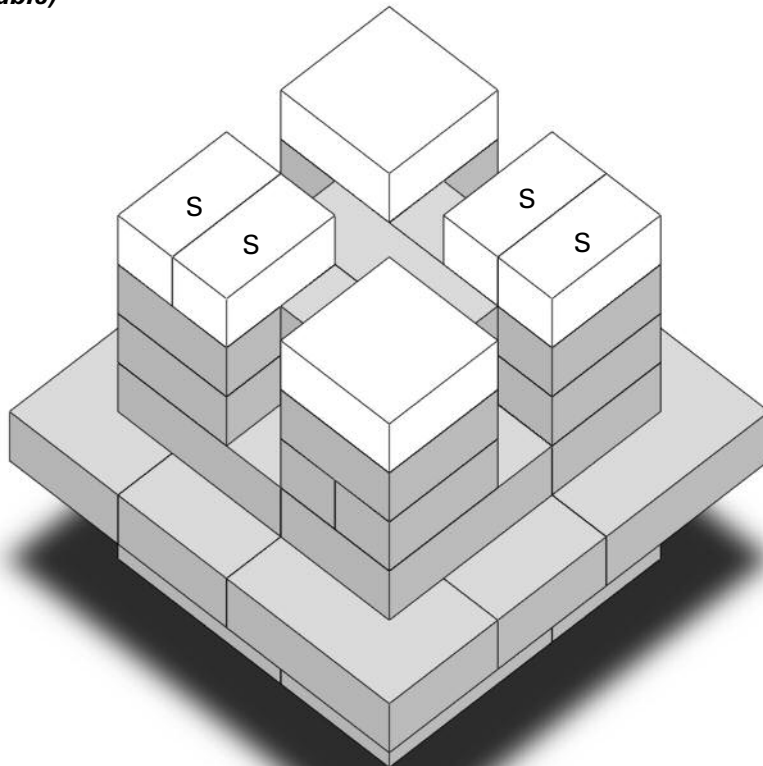

Course 9 (Pub Table)

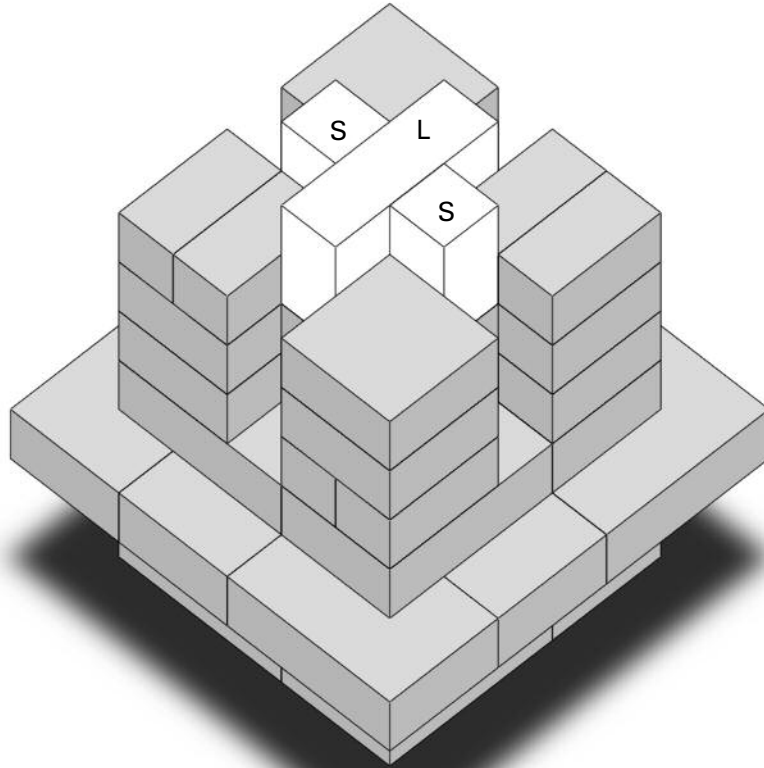

Course 10 (Pub Table)

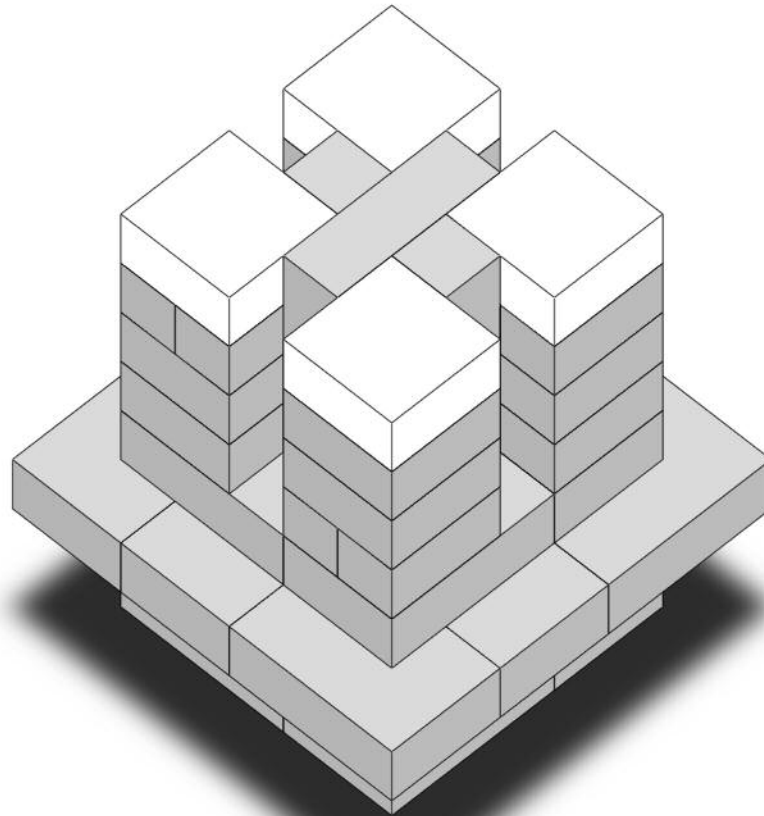

Course 11 (Pub Table)

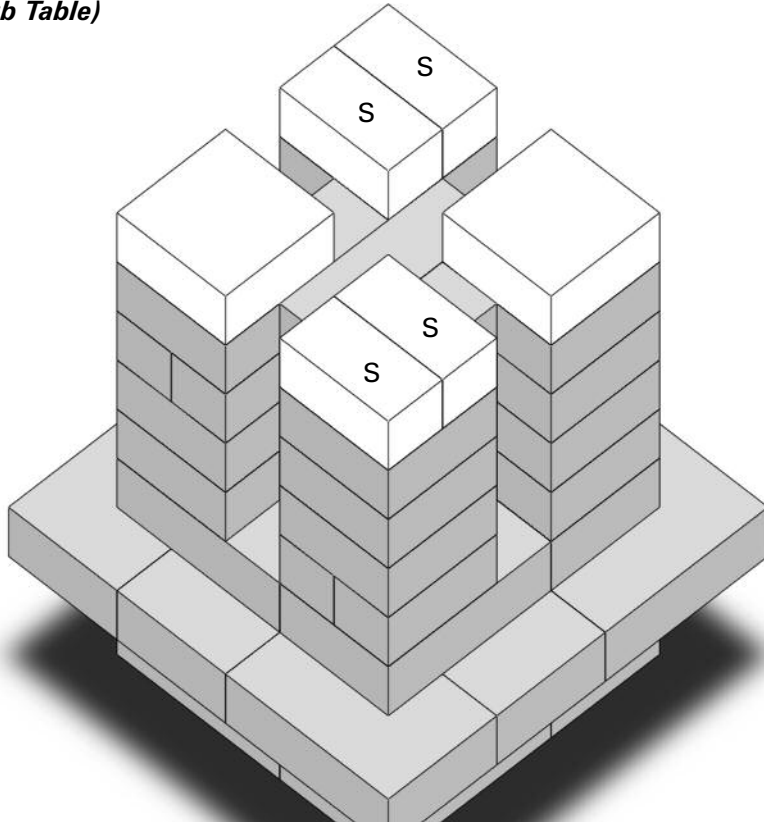

Course 12 (Pub Table)

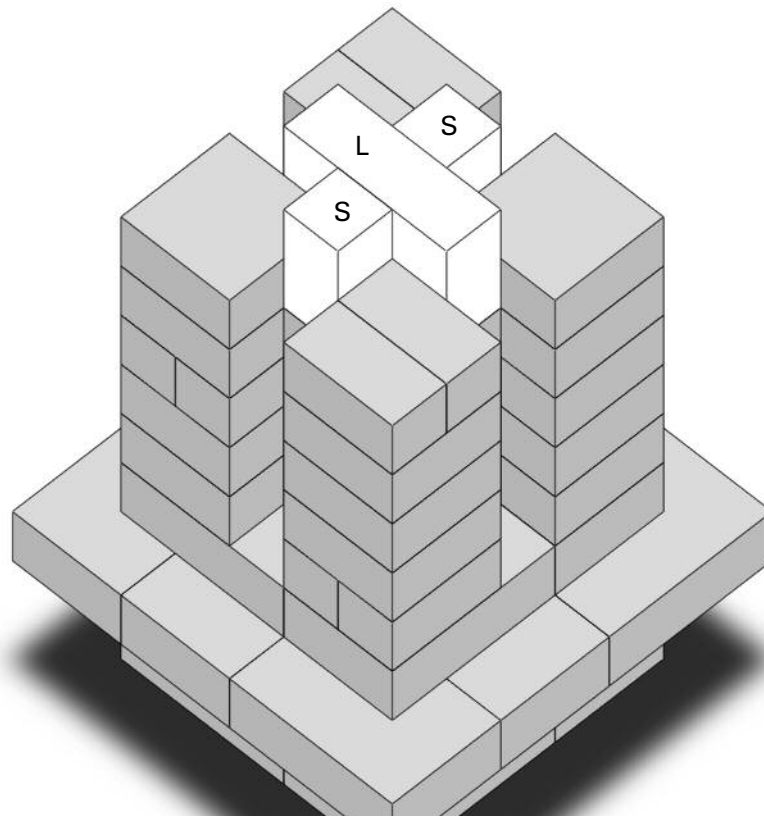

Course 13 (Pub Table)

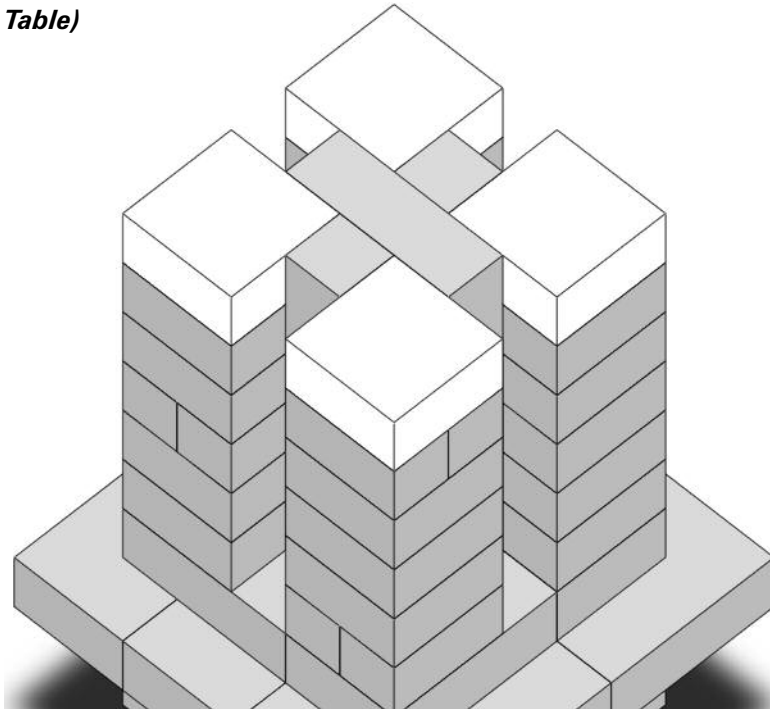

Final Step (Pub Table)



IMPORTANT: Allow 72 hrs. for adhesive to set before use.

PLEASE NOTE: As with any concrete product, the age of the products can cause variations in color. Lighter colored Silver Creek tops are older and have cured more than newer, darker tops. Don't be alarmed. As tops age, their color will lighten and blend together.

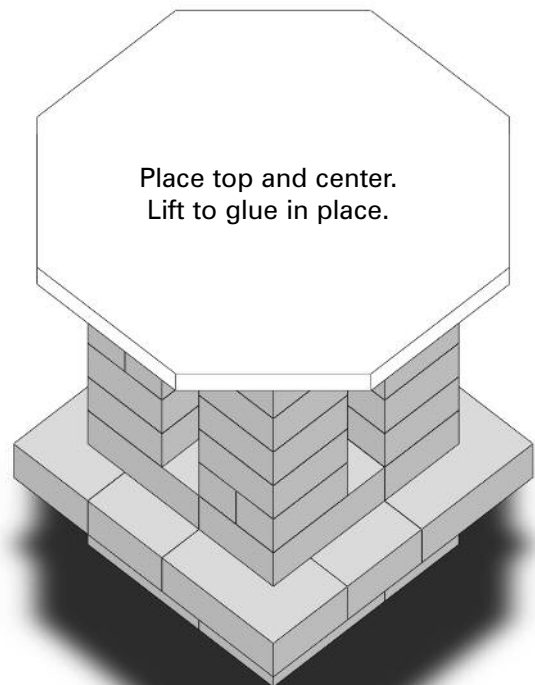

Note: All warranty claims must be made online at: www.outdoorlivingkits.com/warranty.htm

Claims submissions must include the following information:

1. Claimant's name, address, and phone number and the installation address (if different).
2. A description of the product, purchase price, date and location of purchase, and copies of invoices, if available.
3. A description of the defect(s), photos are required.
4. A brief summary of attempts made to address the concerns.

Course 1 (Bistro Table)

Be sure your properly prepared base is level. Begin building by laying your base course as shown.

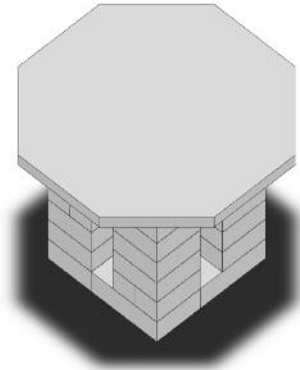

IMPORTANT: Lay glue bead away from outside perimeter to prevent glue from squeezing out between courses

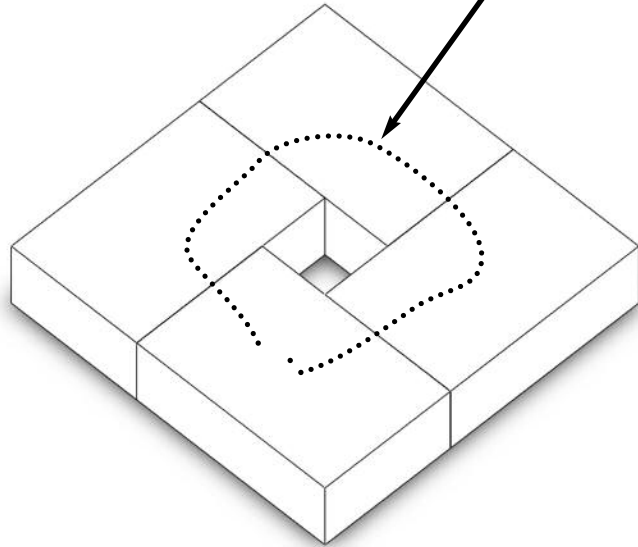

Course 2 (Bistro Table)

Continue to build each course as shown. Use adhesive on each block.

IMPORTANT: Use Super-Stik adhesive on each course. Brush excessive dust from blocks to be glued.

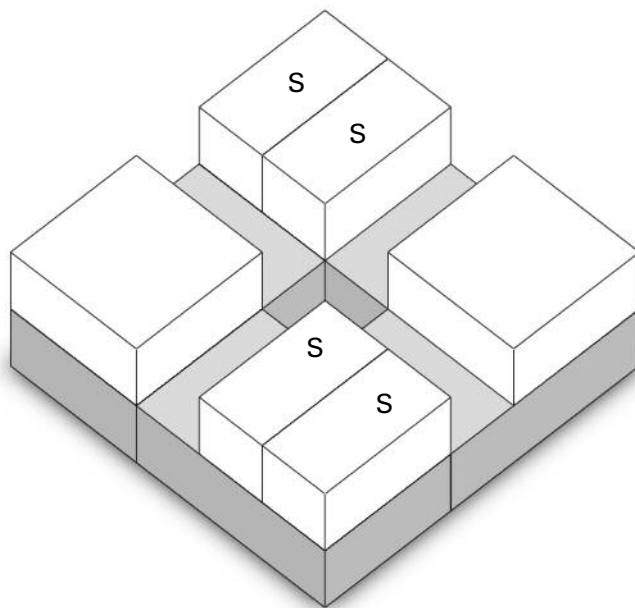

Course 3 *(Bistro Table)*

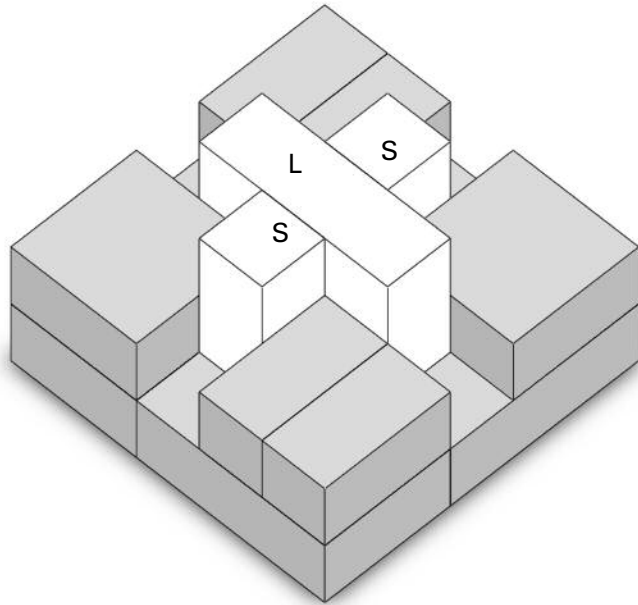

Course 4 *(Bistro Table)*

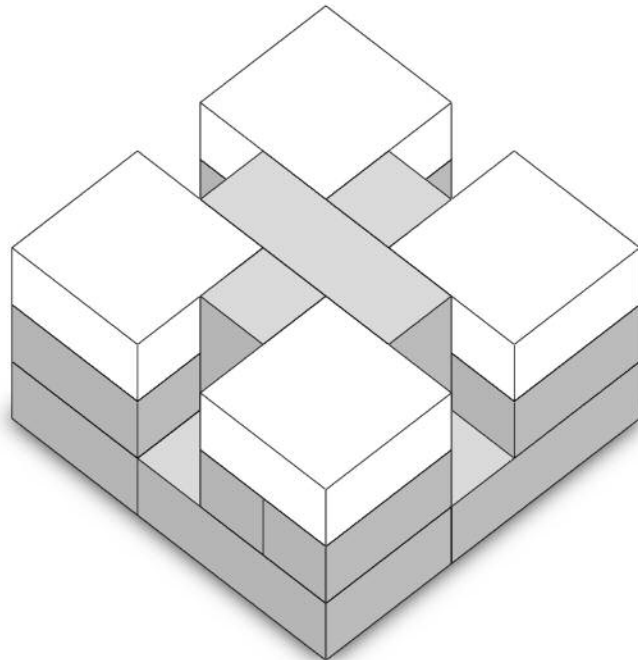

Course 5 *(Bistro Table)*

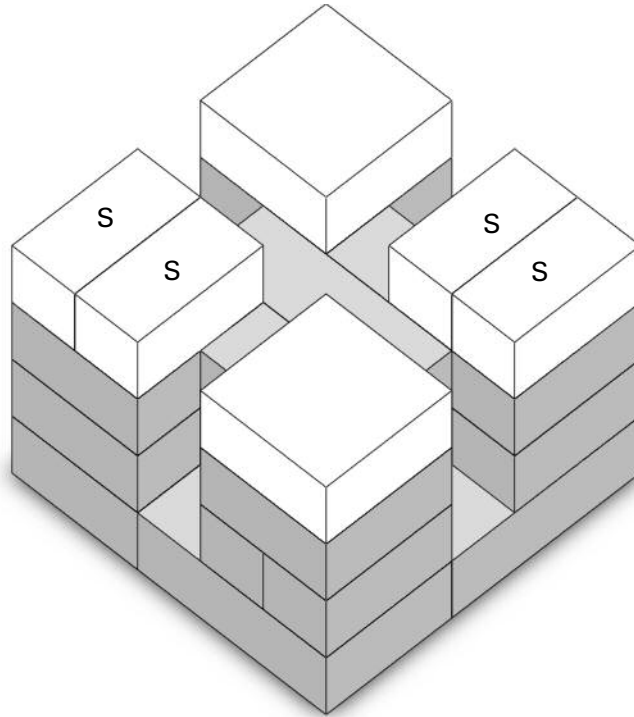

Course 6 *(Bistro Table)*

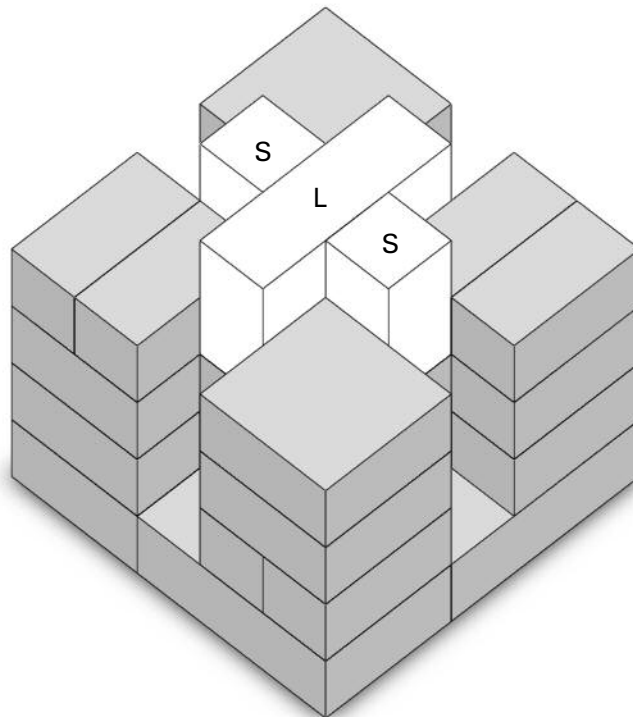

Course 7 (*Bistro Table*)

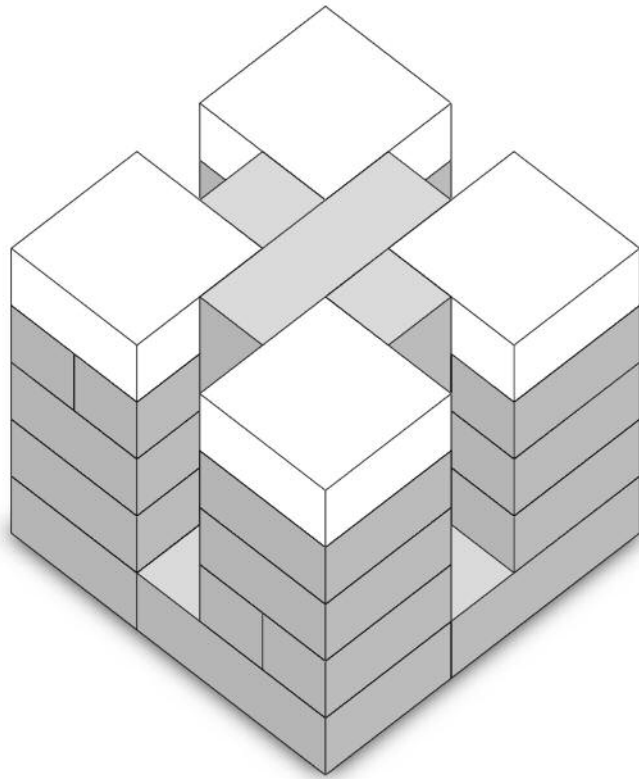

Course 8 (*Bistro Table*)

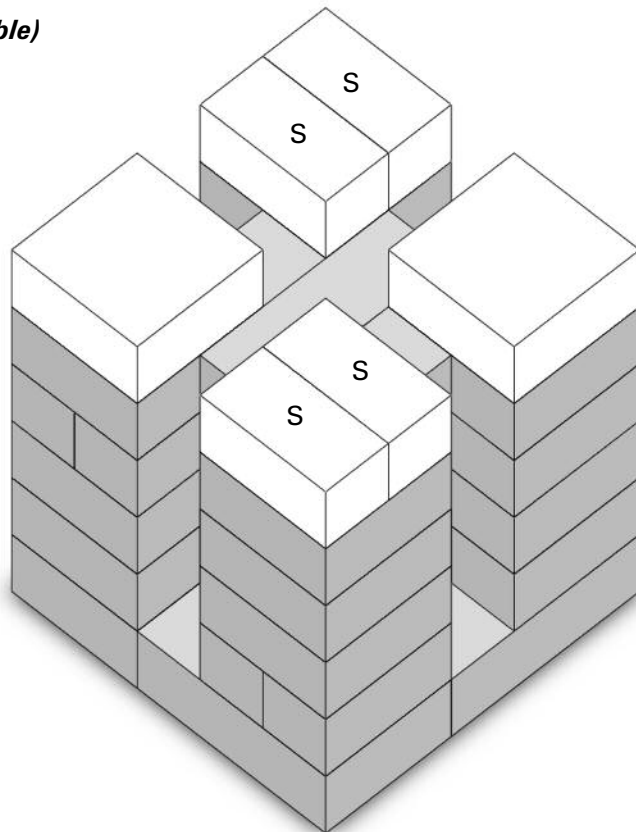

Course 9 *(Bistro Table)*

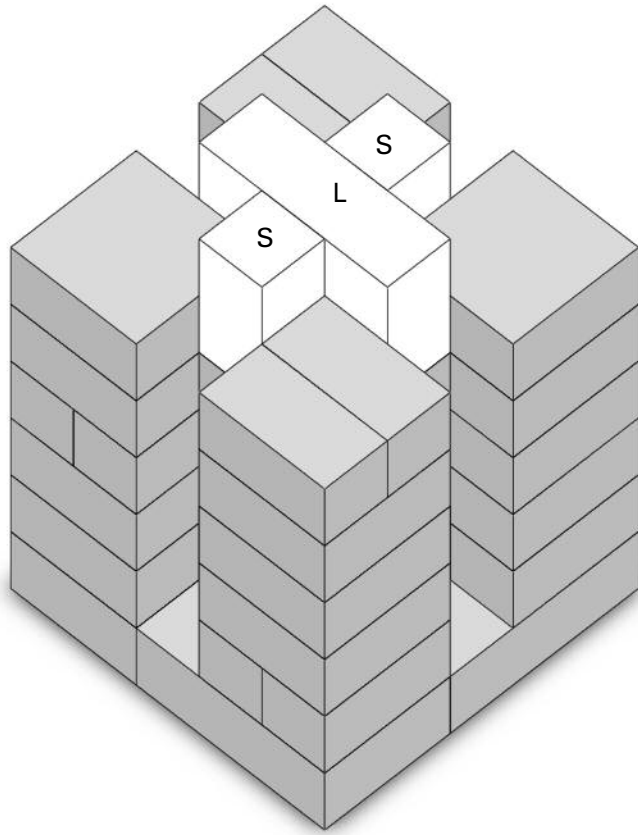

Course 10 *(Bistro Table)*

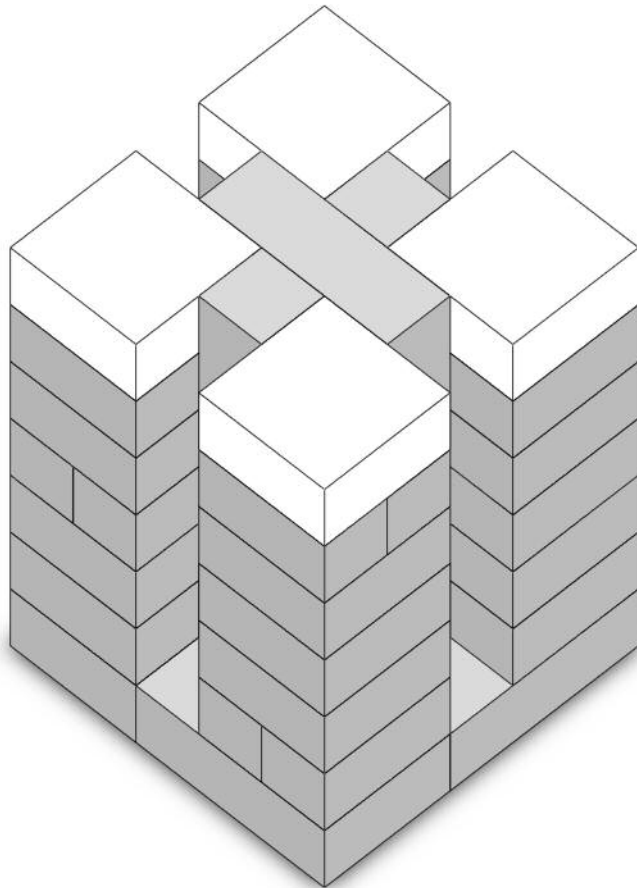

Final Step (Bistro Table)

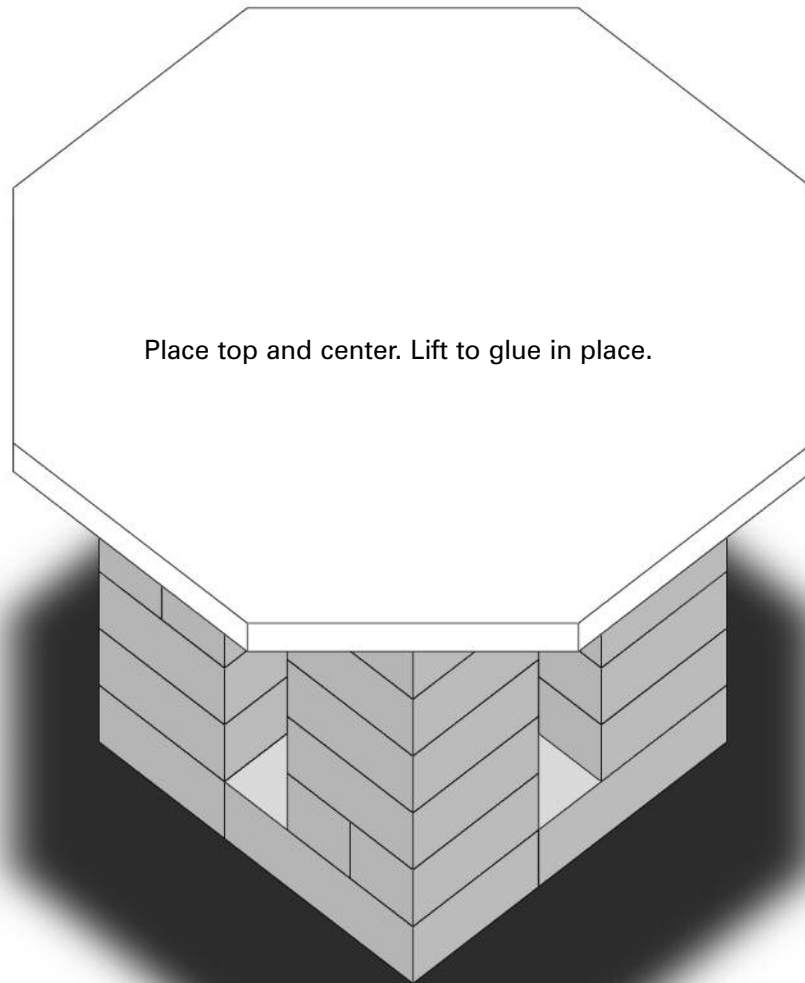

IMPORTANT: Allow 72 hrs. for adhesive to set before use.

PLEASE NOTE: As with any concrete product, the age of the products can cause variations in color. Lighter colored Silver Creek tops are older and have cured more than newer, darker tops. Don't be alarmed. As tops age, their color will lighten and blend together.

Note: All warranty claims must be made online at: www.outdoorlivingkits.com/warranty.htm

Claims submissions must include the following information:

1. Claimant's name, address, and phone number and the installation address (if different).
2. A description of the product, purchase price, date and location of purchase, and copies of invoices, if available.
3. A description of the defect(s), photos are required.
4. A brief summary of attempts made to address the concerns.