

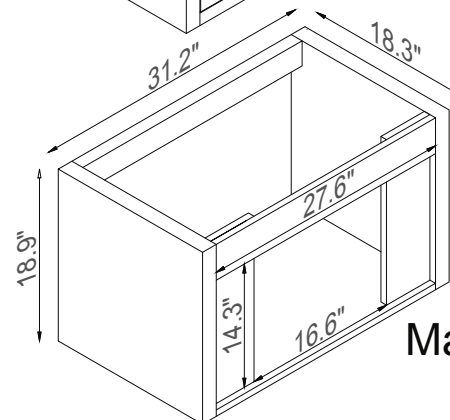

Streamline

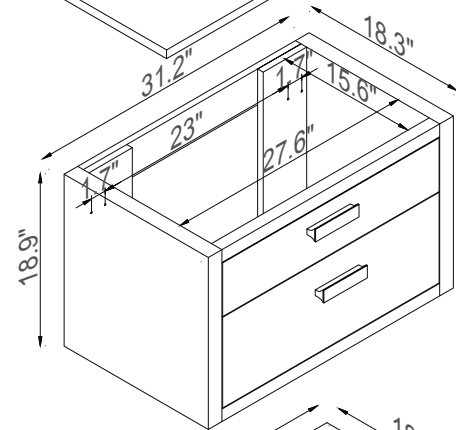
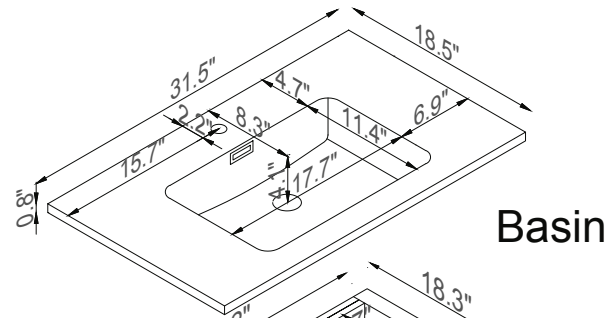

K1820-161-32-55