

Assembly Instructions

Caution : You must read this before you proceed

Table



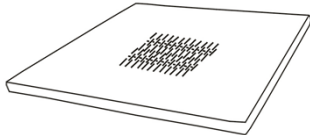
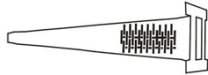

CAUTION : This Table is NOT a TOY.
Keep your child / children at bay during the assembly process.

Parts List

Label	Picture	Description	QTY
A		Woven Table Top	1
B		Table Leg	4

Hardware

Label	Picture	Description	QTY
C		Allen Key	1
D		Screw with Flat Washer Ring	16

Assembly Preparation

Before Beginning Assembly:

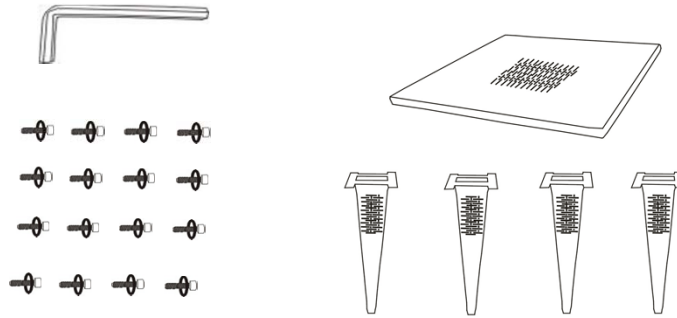

• Read instructions, cover to cover-



• Have 2 adults on hand for assembly-



• Do not assemble on flooring or carpet-



• Assemble on a clean non-marring surface (packing foam)-



• Save all packaging until finished-

Assembly Steps

Step 1

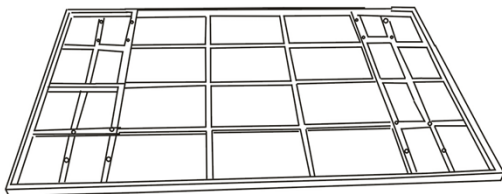

← Table Top being placed upside down

Place the Woven Table Top(A) with top facing downwards on a sofa, clean surface

Step 2

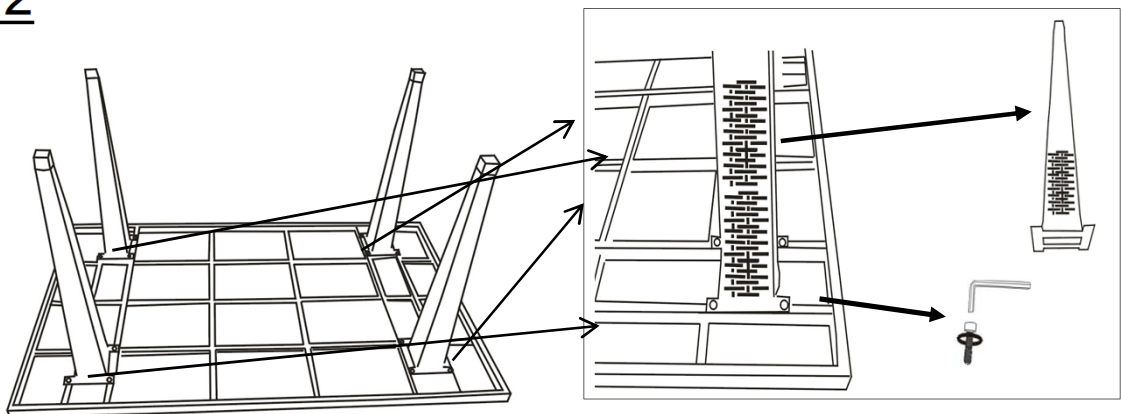





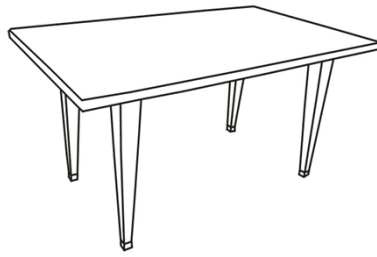



Then, place the table leg(B) over screw points
Attach the screw with Flat Washer Ring(D) onto the contact point as shown in picture.
Tighten screw with the Allen Key(C).

Step 4



Turn the table **RIGHT** Side Up. Your Table is ready for use.

Care & Maintenance

-  ● Do not put **HOT** items directly on furniture surface.
 -  ● Do not clean furniture with **HARSH** cleansers or polish.
 -  ● To prolong product lifetime, **AVOID** placing furniture under direct sunlight.
 -  ● Do not place furniture near **heating or cooling** vents.
 -  ● Do not write on furniture without a padded barrier to protect the surface.
 -  ● To prolong the product lifetime, avoid extended and lengthy exposure to rain and sunshine. Where possible, place under covers and or patio and or awnings.
 -  ● For residential use only. Not for commercial use.
 -  ● Stains may be removed with mild soap solution and damp cloth.
-
-  ● Dust and pick-up spills using a clean, non-colored, lint-free cloth.