



TearDrop



Egg Chair



MoonDrop



UFO



Flying Saucer

FlowerHouse

www.flowerhouses.com (810) 686-8252

FlowerHouse
TearDrop

TearDrop Features:

- Teardrop Hanging Chair by FlowerHouse
- Overall 60" diameter/152cm x 60" tall/152 cm
- 450 lb/204 kg Maximum weight limit
- Relaxing and Fun Indoor/Outdoor Multi-Use Hanging Chair
- Colorful, Durable, Breathable, Washable UV Protected Mesh Fabric

Includes:

- Tear Drop Chair
- 2 Viewing Windows
- Durable Multi-use Carry Bag
- 26 feet/8 meters of Heavy Duty Rope
- Strong Steel Ring Support
- Stainless Steel Screw Closure Locking Carabineer



PRODUCT NAME	MODEL#	PART SIZE HxD (INCHES)	WEIGHT LBS
TEARDROP	Model # and colors shown in photos below	60" x 60"	16
BUG NET	FHTD/FS-NET	60" x 60"	1
WEATHER COVER	FHTD/FS-CVR	60" x 60"	1
STAND	FHHFS	95" x 95"	60



FHTDCL-Cloud



LIMIT 2 PEOPLE
DO NOT JUMP

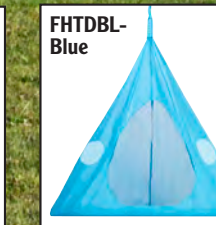

FlowerHouse
Flying Saucer

84"/213 cm Diameter
 x 72"/182cm High



Flying Saucer Features:

- Flying Saucer Hanging Bed/Chair by FlowerHouse
- Relaxing and Fun Indoor/Outdoor Multi-Use Hanging Bed
- Durable, Breathable, Washable UV Protected Mesh Fabric
- 450 lb/204 kg maximum weight limit
- Includes:
 - Flying Saucer Hanging Bed/Chair
 - Durable Multi-use Carry Bag
 - Stainless steel screw closure locking carabineer
 - Strong Steel Ring Support
 - 26 feet/8 meters of heavy duty rope
 - Free Bug Net

Flying Saucer Bug Net FHMD/FS-NET Included



Flying Saucer Weather Cover also available Sold Separately FHMD/FS-CVR



Flying Saucer Stand also available Sold Separately FHHFS



PRODUCT NAME	MODEL#	PART SIZE HxD (INCHES)	WEIGHT LBS
FLYING SAUCER	FHFSSVR	84" x 72"	22
BUG NET INCLUDED	FHMD/FS-NET	84" x 72"	1
WEATHER COVER	FHMD/FS-CVR	84" x 72"	1
STAND	FHHFS	95" x 95"	60



LIMIT 2 PEOPLE
 DO NOT JUMP



MoonDrop
Green
FHMD-G

MoonDrop Features:

- Moon Drop Hanging Bed/Chair by FlowerHouse available in dark green and bark. Other colors on customer request.
- Relaxing and Fun Indoor/Outdoor Multi-Use Hanging Bed/Chair
- Durable, Breathable, Washable UV Protected Mesh Fabric
- 450 lb/204 kg maximum weight limit
- Includes:
 - Moon Drop Hanging Bed/Chair
 - Durable Multi-use Carry Bag
 - Stainless steel screw closure locking carabineer
 - Strong Steel Ring Support
 - Multiple Viewing Windows
 - 26 feet/8 meters of heavy duty rope



MoonDrop Bug Net
also available
Sold Separately
FHMD/FS-NET



MoonDrop Weather Cover
also available
Sold Separately
FHMD/FS-CVR

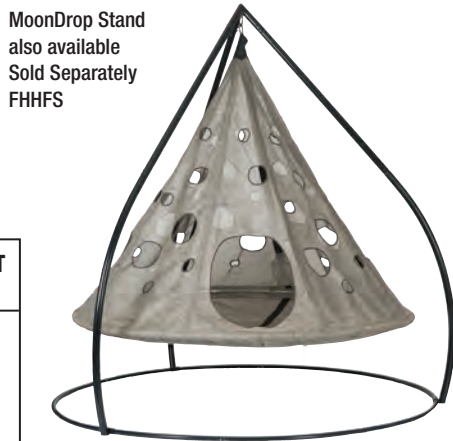

MoonDrop Stand
also available
Sold Separately
FHHFS

PRODUCT NAME	MODEL#	PART SIZE	WEIGHT
		HxD (INCHES)	LBS
MOONDROP-Bark	FHMDBRK	84" x 72"	25
MOONDROP-Green	FHMD-G	84" x 72"	25
BUG NET	FHMD/FS-NET	84" x 72"	1
WEATHER COVER	FHMD/FS-CVR	84" x 72"	1
STAND	FHHFS	95" x 95"	60

www.flowerhouses.com (810) 686-8252



FlowerHouse
Moon Drop

84"/213 cm Diameter
x 72"/182cm High

MoonDrop Bark
FHMD-BRK

LIMIT 2 PEOPLE
DO NOT JUMP

FlowerHouse
UFO

84"/213 cm Diameter
x 42"/106 cm High



UFO Features:

- UFO Hanging Bed/Chair by FlowerHouse
- Relaxing and Fun Indoor/Outdoor Multi-Use Hanging Bed/Chair
- Durable, Breathable, Washable UV Protected Mesh Fabric
- 450 lb/204 kg maximum weight limit
- Includes:
UFO Hanging Bed/Chair
Durable Multi-use Carry Bag
Stainless steel screw closure locking carabineer
Strong Steel Ring Support
Multiple Viewing Windows
26 feet/8 meters of heavy duty rope

LIMIT 2 PEOPLE
DO NOT JUMP

PRODUCT NAME	MODEL#	PART SIZE HxD (INCHES)	WEIGHT LBS
UFO	FHFUFOSVR	72" x 84"	25
UFO BUG NET	FHUFO-NET	72" x 84"	.75
UFO WEATHER COVER	FHUFO-CVR	72" x 84"	1
STAND	FHHFS	95" x 95"	60

FlowerHouse

www.flowerhouses.com (810) 686-8252



UFO Stand also available Sold Separately FHHFS



UFO Bug Net also available Sold Separately FHUFO-NET



UFO Weather Cover also available Sold Separately FHUFO-CVR



Egg Chair . . . Time to Enjoy Your Garden!

This Stylish Hanging Chair adds a eye catching design and comfortable place to stop and enjoy all your beautiful garden labors! Arrives in one manageable box with both chair and stand included.

Lots of fun colors to choose from!

- Classic comfortable design.
- A beautiful place to relax in your home and garden.
- Durable, washable, weather resistant fabric.
- Overall: 66" tall on stand.
Egg: 34" wide x 43" high opening.
Cushion: 29" wide x 24" deep x 3" thick.
Back Pillow: 20" wide x 17" tall x 5" thick.
- 300 lb/136 kg Maximum weight limit.

Also available:
Silver Weather Cover for Egg Chairs



PRODUCT NAME	MODEL#	PART SIZE	WEIGHT
		H x W x D (INCHES)	LBS
Egg Chair with Stand Light Blue	FHEC100-LB	66 x 34 x 24	60
Egg Chair with Stand Bark	FHEC100-BRK	66 x 34 x 24	60
Egg Chair with Stand Red	FHEC100-RD	66 x 34 x 24	60
Egg Chair with Stand Dark Blue	FHEC100-BL	66 x 34 x 24	60
Egg Chair with Stand Light Green	FHEC100-GR	66 x 34 x 24	60
Egg Chair Cover	FHEC-CVR		



Egg Chair with Stand, more colors available

Egg Chair Junior



- Perfect size for little ones to swing all day. In 2 color choices: Striped and Blue Cloud.
- Durable, washable weather resistant fabric.



- Overall: 46" tall on stand.
Egg: 26" wide x 34" high opening.
Cushion: 21" wide x 18" deep x 3" deep.
Back Pillow: 15" wide, 10" tall and 5" thick.

- 200 lb/91 kg Maximum weight limit.

PRODUCT NAME	MODEL#	PART SIZE	WEIGHT
		H x W x D (INCHES)	LBS
Egg Chair Junior w/ Stand Striped	FHJC100-STR	35 x 34 x 8	42
Egg Chair Junior w/ Stand Blue Cloud	FHJC100-BC	35 x 34 x 8	42
Egg Junior Chair Cover	FHJC-CVR		
Pumpkin Loveseat Chair w/ Stand Red	FHPC100-RD	66 x 50 x 24	70
Pumpkin Loveseat Chair w/ Stand Bark	FHPC100-BRK	66 x 50 x 24	70
Pumpkin Loveseat Chair w/ Stand Orange	FHPC100-OR	66 x 50 x 24	70
Pumpkin Chair Cover	FHPC-CVR		

All NEW Pumpkin Loveseat Chair . . . Room for 2 to Relax in Your Garden!

Pumpkin Loveseat Chair

- Classic comfortable design with room for 2.
- A comfy place to relax in home and garden.
- Overall: 66" tall on stand.
Pumpkin: 50" wide x 43" high opening.
Cushion: 48" wide x 36" deep x 5" thick.



- Durable, washable weather resistant fabric.
- 400 lb/181 kg maximum weight limit.

Also available: Silver Weather Cover for Pumpkin and Junior Chairs



Pumpkin Loveseat Chair with Stand, more colors available



FlowerHouse

Sit back and enjoy your outdoor spaces on our elegant and beautiful Twin Butterfly Bistro Set



Shown: White Bistro Set. Custom colors available choose from light yellow, butterfly orange and sky blue in container quantity or custom paint your own set at home.



FlowerHouse

UNIQUE CAST ALUMINUM
Twin Butterfly
Bistro Set

Our Twin Butterfly Bistro Set is a beautiful new design and the perfect addition to any garden so you can literally 'stop and smell the roses' with this idyllic seating arrangement!

Functional, elegant, and sturdy the Twin Butterfly Bistro Set adds a focal point to your home and garden. The classic wrought iron design is made of light rust-free cast aluminum, with an all-weather powder-coated finish. Easily assembles to full adult size, comfortable attractive art.

Choose from black, white or antique finishes.



Antique Bistro Set

PRODUCT NAME	MODEL#	PART SIZE HEIGHT DIA (INCHES)	WEIGHT LBS
CAST ALUMINUM BUTTERFLY BISTRO SET			
3 PC BLACK SET	FH3PSET	CHAIR BACK 35"H	11 LBS
3 PC WHITE SET	FH3PSET-W	CHAIR SEAT 18"DIA	
3 PC ANTIQUE SET	FH3PSET-A	TABLE 27"H - 21.25"DIA	10 LBS



Black Bistro Set



Black Bistro Set



Add a Touch of Elegance to Your Home and Garden.

Sit back and enjoy your outdoor spaces on our beautiful, practical Butterfly Furniture.



Bench Face Detail



Antique Finish Chair

PRODUCT NAME	MODEL#	PART SIZE H x W x D (INCHES)	WEIGHT LBS
CAST ALUMINUM BUTTERFLY BENCH			
BLACK BENCH	FHBF06	35 x 46 x 27	51
WHITE BENCH	FHBF06-W	35 x 46 x 27	51
ANTIQUE BENCH	FHBF06-A	35 x 46 x 27	51
CAST ALUMINUM BUTTERFLY TABLE			
BLACK TABLE	FHBFTA07	28H x 30Dia	31
WHITE TABLE	FHBFTA07-W	28H x 30Dia	31
ANTIQUE TABLE	FHBFTA07-A	28H x 30Dia	31
CAST ALUMINUM BUTTERFLY CHAIR			
BLACK CHAIR	FHBC05	35 x 25 x 25	24
WHITE CHAIR	FHBC05-W	35 x 25 x 25	24
ANTIQUE CHAIR	FHBC05-A	35 x 25 x 25	24

UNIQUE CAST ALUMINUM Butterfly Furniture

This beautiful Butterfly Furniture will add a functional, elegant, focal point to your home and garden. Classic wrought iron design in a light rust-free cast aluminum.

Durable all weather powder coated finish. Easily assembles to full adult size, comfortable attractive art. Choose from black, white or antique finishes.



Antique Finish





X-Up Space Saving Shelves

3-Tier Exy Shelf
32”h x 34”w x 14”d



White 3-Tier Shelf



Sets Up Easily in Just Minutes

Exy X-Up Shelves Feature:

- Easy lift and lock setup.
- Sturdy durable all steel construction.
- Holds Up to 40 evenly distributed lbs per shelf.
- Indoor or outdoor storage and organization needs for garage, closet, toys, tools, shoes, plants, pantry, you name it, this is an easy space-saving solution!
- All sizes of Exy shelves available in black and in white.

White 4-Tier Narrow Shelf



4-Tier Narrow Exy Shelf

48”h x 20”w x 14”d



EXY X-UP SHELF	MODEL#	PART SIZE HxWxD(INCHES)	STORED SIZE HxWxD(INCHES)	WEIGHT LBS
3 TIER Black	EXY30B	32 x 34 x 14	5 x 27 x 22.5	10
3 TIER White	EXY30W	32 x 34 x 14	5 x 27 x 22.5	10
4 TIER Narrow Black	EXY41B	48 x 20 x 14	7 x 29 x 21	10
4 TIER Narrow White	EXY41W	48 x 20 x 14	7 x 29 x 21	10
4 TIER Black	EXY40B	48 x 26 x 15	14 x 25.5 x 21	12
4 TIER White	EXY40W	48 x 26 x 15	14 x 25.5 x 21	12
5 TIER Black	EXY50B	80 x 56 x 70	14 x 25.5 x 21	17
5 TIER White	EXY50W	80 x 56 x 70	14 x 25.5 x 21	17



White 4-Tier Shelf



4-Tier Exy Shelf

48”h x 26”w x 15”d



White 5-Tier Shelf



5-Tier Exy Shelf

64”h x 34”w x 14”d





FlowerHouse
**Maui
 Sea Life
 Hooks**



PRODUCT NAME	MODEL#	PART SIZE (INCHES/CM)
STAR FISH-Antique	FHMSF-A	4.25x4"/ 11x10cm
STAR FISH-White	FHMSF-W	4.25x4"/ 11x10cm
MERMAID Large-Antique	FHMM-LA	9x6"/ 23x16cm
MERMAID Large-White	FHMM-LW	9x6"/ 23x16cm
MERMAID Small-Antique	FHMM-SA	5.5x2"/14x5cm
MERMAID Small-White	FHMM-SW	5.5x2"/14x5cm
FISH BONES Large-Antique	FHMF-LA	18.5"x6"/47x16cm
FISH BONES Large-White	FHMF-LW	18.5"x6"/ 47cmx16cm
FISH BONES Small-Antique	FHMF-SA	14"x4.75"/ 35x12cm
FISH BONES Small-White	FHMF-SW	14"x4.75"/35x12cm
SEA HORSE Large-Antique	FHMSH-LA	5.25x2"/ 13x5cm
SEA HORSE Large-White	FHMSH-LW	5.25x2"/ 13x5cm
SEA HORSE Small-Antique	FHMSH-SA	5x2"/ 12x5cm
SEA HORSE Small-White	FHMSH-SW	5x2"/ 12x5cm
SEA TURTLE -Antique	FHMST-A	4x4.25"/ 10x11cm
SEA TURTLE-White	FHMST-W	4x4.25"/ 10x11cm
SEA SHELL -Antique	FHMSS-A	4x3.5"/ 10.5x9cm
SEA SHELL-White	FHMSS-W	4x3.5"/ 10.5x9cm
OCTOPUS-Antique	FHMO-A	4x4.5"/10.5x11.5cm
OCTOPUS-White	FHMO-W	4x4.5"/10.5x11.5cm
HUMPBACK-Antique	FHMHW-A	5.25x4.5"/ 13x11.5cm
HUMPBACK-White	FHMHW-W	5.25x4.5"/ 13x11.5cm
SPERM WHALE-Antique	FHMWS-A	6.5x4.25"/ 16.5x11cm
SPERM WHALE-White	FHMWS-W	6.5x4.25"/ 16.5x11cm
ANCHOR-Antique	FHMA-A	4.25x3.75"/11x9.5cm
ANCHOR-White	FHMA-W	4.25x3.75"/11x9.5cm
WHALE TAIL-Antique	FHMWT-A	3.5x4.25"/9x11cm
WHALE TAIL-White	FHMWT-W	3.5x4.25"/9x11cm

Maui Sea Life Hooks Features: Decorative hooks are made of durable rust free aluminium, so they will never leave rust marks on your clothing! This attractive and practical decor is available in antique black (re-paintable) or bright white powder coated finish! Available Individually or as sets.

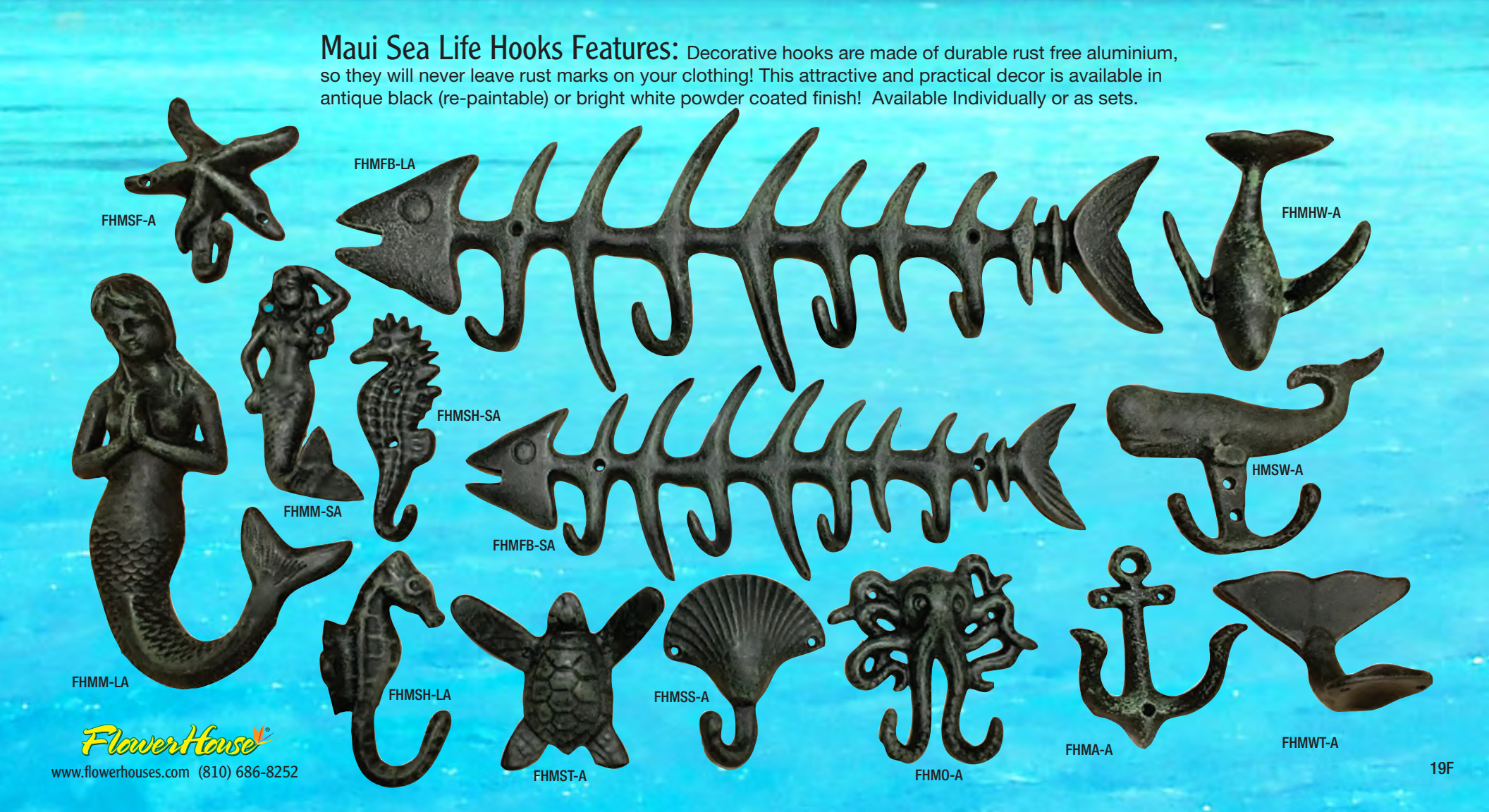

FlowerHouse
 www.flowerhouses.com (810) 686-8252

FlowerHouse

INNOVATIVE OUTDOOR SOLUTIONS



SpringHouse

Easy Pop-Up!

StarterHouseClear

Easy Pop-Up!



Sets Up Easily in Just Minutes

PlantTower
with X-asp technology!

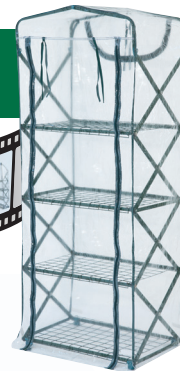

HarvestHouse^{PRO}
with X-asp technology!



HarvestHouse^{PLUS}
with X-asp technology!

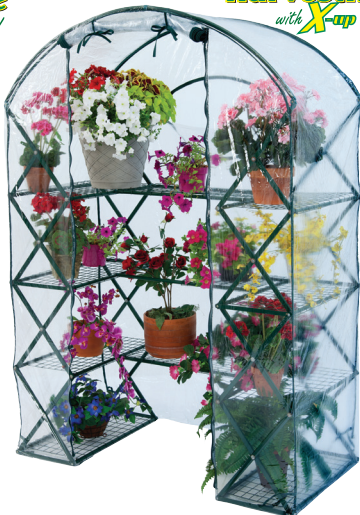

BIG House

BIG House sizes range from
8' h x 6' w x 8' deep to
10' h x 12' w x 120' deep

Dear Valued Customers,

We've been working hard to continue to bring you unique cost-effective innovations for your Home and Garden. We are very pleased to introduce our **new Hanging Furniture** totally unique and fun for all ages. Enjoy it indoors and outdoors camping or at the beach!

Discover our award winning one-of-a-kind Pop-Up Greenhouses and Storage Sheds, Harvest House Series with X-Up Technology and our **ALL NEW ECLIPSE LIGHT DEP GREENHOUSE** System. This is a flower forcer system that can increase your harvest from one crop per year to three crops a year!

We've made gardening easier than ever with our lift and lock X-Up Shelving Systems, Eclipse System and the POP-Up greenhouses!

Be sure to experience the comfort and affordability of our unique **Egg Chair family** of products, the Pumpkin Loveseat, the original Egg Chair and Egg Chair Junior. Our **Butterfly Furniture** line with the Original Cast Aluminum Butterfly Twin and Butterfly Bistro Set is a beautiful addition to any home or garden.

Discover our easy way to maximize your harvest with our automatic **Solar Rain Maker**. A great way to water hanging pots, and containers – the perfect addition to all of our greenhouses.

We value our customers and thank you for your continued support.

Sincerely,
Scott Wehner
and the FlowerHouse Team

www.flowerhouses.com (810) 686-8252



GREENHOUSE AND LIGHT DEPRIVATION SYSTEM 9'h x 12'w x 24'd (50' and 100' long also available)

Eclipse Features:

- Extremely spacious greenhouse!
- Easy one person on and off operation of the light deprivation cover.

Kit Includes:

- Powder Coated Steel Tube Greenhouse Frame.
- Clear GRO-TEC™ Cover with Rip Stop. See page 10.
- Black and White Light Deprivation Cover.
- 2 Steel Tube Arms, 2 Steel Plate Bases, 1 Steel Tube Crutch Pole.



Greenhouse and Light Deprivation System 9'h x 12'w x 24'd

Light Dep



PRODUCT NAME	MODEL#	PART SIZE HxWxD (FEET)	WEIGHT LBS
ECLIPSE 24	FHECL24	9' x 12' x 24'	310



www.flowerhouses.com (810) 686-8252

FlowerHouse®

FLAT TOP

10' high x 12' wide x 24' long

FlatTop Features:

- Modular Indoor Grow House and Drying Room
- The Largest Grow House in the World
- 10' or 8' High size options in one box.
- 12' Wide x 24' Long with 10" Ducts
- Two large zippered doors with viewing windows
- Large 32 mm steel tube frame high gloss white powder coated finish
- Heavy duty 6 mil black and white cover
- Easy snap-on film clips included, to secure cover to frame
- Gusseted vertical supports every 6 feet to support lights and other hardware
- Fully modular system that can be joined together end to end or side by side to fit any building's configuration

MODULAR INDOOR GROW HOUSE



8' high



10' high



Clips included to attach cover to frame easily

Part # GHFT

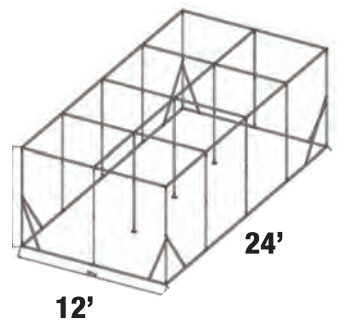

12'

24'

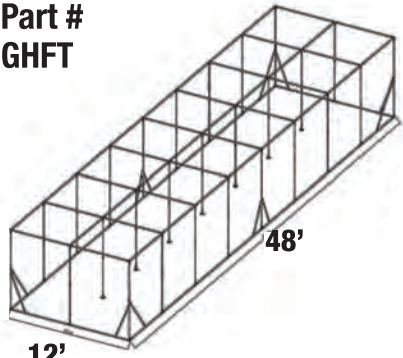

48'

12'

2 shown end to end

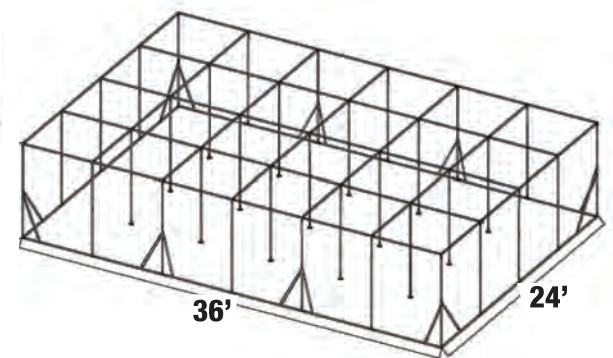

36'

24'

3 shown side by side

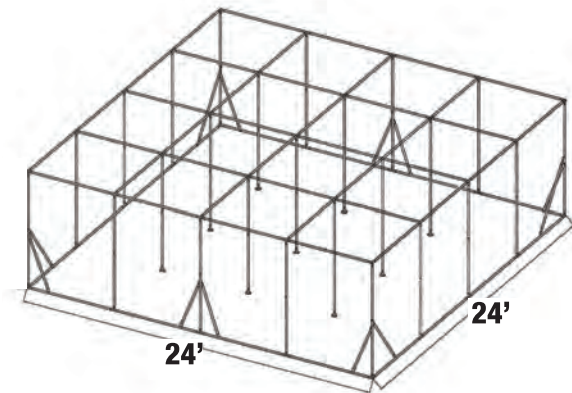

24'

24'

2 shown side by side



www.flowerhouses.com (810) 686-8252

BIG Houses

Big House 688 & 10109 Features:

- Amazing Height Space: 8 Feet and 9 Feet Tall!
- Includes GRO-TEC™ Slip-On Cover. See page 12.
- Beautiful Design inspired by Classic GreenHouses.
- Powder Coated Steel Frame.
- Cable Bridge Support.

- Walk-In Design with Zippered Door.
- Essential Cross Ventilation with large zippered openings.
- Ideal environment for seed starting, propagation, and plant growth.
- Sets up anywhere, soil or hard surface, indoors or outdoors.
- Makes a great space saving display area for your plants.
- Protects plants from wind, frost, snow, insects, birds and other pests.

PRODUCT NAME	MODEL#	PART SIZE		WEIGHT
		HxWxD (FEET)	HxWxL (INCHES)	LBS
BIGHOUSE 688	FHBH688	8' x 6' x 8'	17 x 4	75
BIGHOUSE 10109	FHBH10109	9' x 10' x 10'	12 x 17x 63	105



FHBH688
8 Feet Tall

8'h x 6'w x 8'd



Optional Storage/FlowerForcer Cover Available



Optional Storage/FlowerForcer Cover Available



FHBH10109
9 Feet Tall

9'h x 10'w x 10'd



Optional X-Up Solving Available
FHFH700SHV:
44" h x 108" w x 19" d
Fits BIGHOUSE FHBH688 and FHBH10109

BIG Houses

Big House 1212-12120 Series Features:

- Tallest BigHouse Series All 10 Feet Tall!
- Includes GRO-TEC™ Slip-On Cover. See page 12.
- Beautiful Design inspired by Classic GreenHouses.
- Easy Quick Set Up – No Tools Required!
- Compact storage when not in use.
- Walk-In Design with Zippered Door.
- Essential Cross Ventilation with large zippered openings.
- Ideal environment for seed starting, propagation, and plant growth.
- Sets up anywhere, soil or hard surface, indoors or outdoors.
- Makes a great space saving display area for your plants.
- Protects plants from wind, frost, snow, insects, birds and other pests.

PRODUCT NAME	MODEL#	PART SIZE
		HxWxD (FEET)
BIGHOUSE 1212	FHGH1212	10' x 12' x 12'
BIGHOUSE 1218	FHGH1218	10' x 12' x 18'
BIGHOUSE 1230	FHGH1230	10' x 12' x 30'
BIGHOUSE 1260	FHGH1260	10' x 12' x 60'
BIGHOUSE 1290	FHGH1290	10' x 12' x 90'
BIGHOUSE 12120	FHGH12120	10' x 12' x 120'

Big Houses
12ft - 120ft deep
All 10 Feet Tall



10'h x 12'w x 18'd



www.flowerhouses.com (810) 686-8252

BIG Houses sizes:

- 10'h x 12'w x 12'd
- 10'h x 12'w x 18'd
- 10'h x 12'w x 30'd
- 10'h x 12'w x 60'd
- 10'h x 12'w x 90'd
- 10'h x 12'w x 120'd

Plant Tower
with X-up technology!

63”h x 27”w x 19”d

The compact size of the Harvest House X-Up Plant Tower is ideal for apartments and small decks. Interchangeable covers available for multiple uses.



GRO-TEC™ Cover
FHXUPT-GT

Bug Net Cover
FHXUPT-BG

Storage Cover
FHXUPT-SC

Optional Slip On Covers:



Sets Up Easily in Just Minutes

USA and Foreign Patents

MODEL# FHXUPT

PART SIZE: 63”h x 27”w x 19”d

STORED SIZE: 5”h x 27”w x 22.5”d

WEIGHT: 19 lb

Clear Cover Included.

Interchangeable covers available for multiple uses.

Presenting Our HarvestHouse X-up GreenHouse Series:

Our NEW X-UP technology gives an extraordinarily easy set-up and take-down of our sturdy FlowerHouse® shelving while providing maximum light and heat transmission with the clear cover.

Our HarvestHouse X-up Series Feature:

- Quick and Easy Set Up:
 - Lift and lock X-Up shelves in place.
 - Easy Connect Frame Pieces.
 - Sets Up on Soil or Hard Surfaces
 - Stakes, High Wind Tie Downs Included. (Plant Tower X-Up excluded)
 - Folds down for Compact Storage when not in use.
- Optional Slip On Covers:
 - Clear Greenhouse Cover for maximum heat and light for plants.
 - Rugged GRO-TEC™ Greenhouse cover the BEST for plant growth, diffuses light. See page 10.
 - Protective Net Cover keeps out Birds, Bugs and Pests.
 - Grey Storage Cover with Black Light Deprivation Liner doubles as a FlowerForcer Cover.



www.flowerhouses.com (810) 686-8252

MODEL# FHXUPL

PART SIZE: 80”h x 56”w x 30”d

STORED SIZE: 7”h x 29”w x 21”d

WEIGHT: 33 lb

Clear Cover Included.

Interchangeable covers available for multiple uses.

Optional Slip On Covers:



Storage Cover
FHXUPL-SC

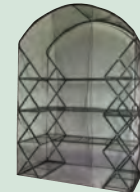

Bug Net Cover
FHXUPL-BG



GRO-TEC™ Cover
FHXUPL-GT

HarvestHouse PLUS
with X-up technology!

6.5”h x 4.5”w x 2.5”d



Shown: Clear Cover FHXUPL-CC

Optional Slip On Covers:



Storage Cover
FHXUPR-SC

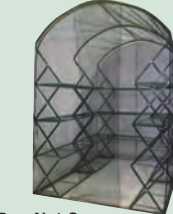

Bug Net Cover
FHXUPR-BG



GRO-TEC™ Cover
FHXUPR-GT



Indoor Grow
Cover
FHXUPR-IC

MODEL# FHXUPR

PART SIZE: 80”h x 56”w x 70”d

STORED SIZE: 14”h x 25.5”w x 21”d

WEIGHT: 70 lb

Clear Cover Included.

Interchangeable covers available for multiple uses.



Shown: Clear Cover FHXUPR-CC

HarvestHouse PRO
with X-up technology!

6.5”h x 4.5”w x 6”d



Sets Up Easily in Just Minutes

USA and Foreign Patents

HarvestHouse^{XL}
with X-up technology!

8'h x 6'w x 9'd

Features:

- NEW! X-Up Technology.
- Includes Clear Slip-On Cover.
- Easy Quick Set Up – No Tools Required!
- Compact storage when not in use.
- Walk-In Design with Zippered Door.
- Essential Cross Ventilation with large zippered openings.
- Ideal environment for seed starting, propagation, and plant growth.
- Sets up anywhere, soil or hard surface, indoors or outdoors.
- Protects plants from wind, frost, snow, insects, birds and other pests.
- Available in either GRO-TEC™ or Clear covers.

PRODUCT NAME	MODEL#	PART SIZE HxWxD (INCHES)	STORED SIZE H x W x D (INCHES)	WEIGHT LBS
HARVESTHOUSE XUP XL	FHXUP69	96 x 72 x 108	39 x 22 x 7.5 (2 boxes, same size)	50

BIG House 899

Easy Pop-Up!

8.5'h x 8'w x 9'd

BIG House Features:

- Includes GRO-TEC™ Slip-On Cover. See page 12.
- Beautiful Design inspired by Classic GreenHouses.
- Easy Quick Set Up – No Tools Required!
- Compact storage when not in use.
- Walk-In Design with Zippered Door.
- Essential Cross Ventilation with large zippered openings
- Ideal environment for seed starting, propagation, and plant growth.
- Sets up anywhere, soil or hard surface, indoors or outdoors.
- Makes a great space saving display area for your plants.
- Protects plants from wind, frost, snow, insects, birds and other pests.

PRODUCT NAME	MODEL#	PART SIZE HxWxD (FEET)	WEIGHT LBS
BIGHOUSEEZ89	FHBH899GT	8.5 x 9 x 8	46



FlowerHouse

www.flowerhouses.com (810) 686-8252

Our original GRO-TEC™ greenhouses feature GRO-TEC™ exterior sheeting system.

FlowerHouse® greenhouses are constructed with durable GRO-TEC™ material. GRO-TEC™ is UV resistant and features rip stop protection. GRO-TEC™ diffuses or scatters light. Letting in 75% of available light. Diffused light benefits plants both by reducing excess light on upper leaves and by increasing the amount of light reflected onto the lower leaves. See pages 2-5, 9-17, 22-23 for all of our GRO-TEC™ greenhouses.

Start Your Garden With These GRO-TEC™ Greenhouses Features:

- Open bottom allows for placement over existing plants, beds and containers.
- Protects plants from wind, frost and snow.
- Screened vents protect against most insects, birds and other pests.
- Constructed from durable GRO-TEC™ material.
- Full zipper closures and ample screened ventilation.
- Free shade cover, tent stakes and storage bag.
- Lightweight and compact for easy transport and storage.
- Designed to set up on soil or hard surface, in or outdoors.
- Accesses for water hose or power cords are integrated in our greenhouse designs.
- Night temperatures inside your FlowerHouse® will drop to outside temperatures without an additional heat source. See page 30 for heating options.

RowHouse™ Easy Pop-Up!

1'h x 12'w x 2'd

- 12' long to cover early plantings.

SeedHouse Jr™

2'h x 2.5'w x 2.5'd

Easy Pop-Up!

- SeedHouse Jr.™ maintains 4 seed flats.
- Great for raised beds.

SeedHouse™ Easy Pop-Up!

3'h x 4'w x 4'd

- SeedHouse™ maintains 8 seed flats.
- Compact size is ideal for apartments and small decks
- Great for raised beds.

StarterHouse™ Easy Pop-Up!

3'h x 8'w x 4'd

- StarterHouse™ maintains 16 seed flats.
- 4' x 8' at base.
- Compact size is ideal for apartments and small decks.
- Great for raised beds.

PRODUCT NAME	MODEL#	PART SIZE HxWxD (INCHES)	STORED SIZE H x W (INCHES)	WEIGHT LBS
ROWHOUSE	FHRH150	12 x 24 x 144	20 x 5	12
SEEDHOUSE JR.	FHSD110	26 x 30 x 30	14 x 4	6
SEEDHOUSE	FHSD100	34 x 48 x 48	20 x 4	9
STARTERHOUSE	FHSH200	34 x 96 x 48	22 x 7	15



FlowerHouse®

www.flowerhouses.com (810) 686-8252

PlantHouses 2, 3 and 4 Feature:

- Use as a winter plant protector for tender shrubs such as azaleas, rhododendrons, hibiscus, and sago palms to name a few.
- Constructed from durable GRO-TEC™ material. See page 12.
- Full zipper closures and ample screened ventilation.
- Free shade cover to diffuse light.
- Free tent stakes and storage bag.
- Provides optimum environment for seed germination, seedling development and hardening off.
- Screened vents protect against most insects, birds and other pests.
- Lightweight and compact for easy transport and storage.
- Protects plants from wind, frost and snow.
- Designed to set up on soil or hard surface, in or outdoors.
- Open bottom allows for placement over existing plants, beds and containers.
- Accesses for water hose or power cords are integrated in our greenhouse designs.
- Night temperatures inside your FlowerHouse® will drop to outside temperatures without an additional heat source. See page 30 for heating options.

PRODUCT NAME	MODEL#	PART SIZE	STORED SIZE	WEIGHT
		HxWxD (INCHES)	H x W (INCHES)	LBS
PLANTHOUSE 2'	FHPH120	28 x 24 x 24	13 x 4	6
PLANTHOUSE 3'	FHPH130	42 x 36 x 36	17 x 4	8
PLANTHOUSE 4'	FHPH140	56 x 48 x 48	22 x 4	12

PlantHouse 2™

2.5'h x 2'w x 2'd

Easy Pop-Up!



PlantHouse 3™

3.5'h x 3'w x 3'd

Easy Pop-Up!



PlantHouse 4™

4.5'h x 4'w x 4'd

Easy Pop-Up!



FlowerHouse®

www.flowerhouses.com (810) 686-8252

FlowerHouse® Solar RainMaker® automatic watering system

The Solar Rainmaker SOL-K12 waters automatically every 3 hours. The amount applied varies depending upon the amount of sunshine and the position of the control knob. The Solar RainMaker SOL-K12 can be set up to water large or small plants, but will always apply more water in sunnier conditions, when your plants need it most. The Solar Rainmaker SOL-K12 can supply up to 12 drippers and is suitable for beds, baskets, vegetables, pots, grow bags, specimen plants and tree establishment.

The Solar Rainmaker SOL-K12 supplies enough water for 6 large hanging baskets or 12-12" pots.

Place the Solar Rainmaker SOL-K12 in a sunny position near your water barrel or similar non-pressured water supply. Insert feeder tube into the water barrel and arrange the drip tubes as required to water your plants. Switch on the unit and your plants will be automatically watered using solar power.

Solar RainMaker SOL-K12
USA and Foreign Patents Pending

Waters Every 3
Hours Using Only
Rainwater And
The Power
Of The Sun,
This Eco-Friendly
Product Irrigates
Your Plants
Automatically.



The Complete Solar RainMaker SOL-K12 Irrigation Kit for use with a barrel or water tank contains:

- 1 Solar RainMaker Pump
- 45 Feet of Irrigation Tube
- 1 Inlet Filter
- 12 Tees
- 12 Drips
- 1 Anti-Siphon Device
- 12 Stakes



Requires 3 AA rechargeable
batteries not included

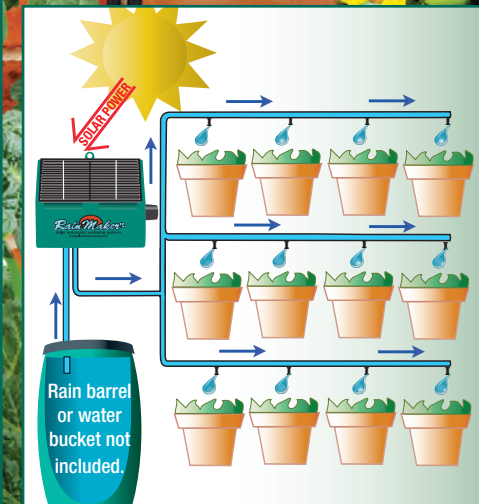

PRODUCT NAME	MODEL#	PART SIZE	WEIGHT
		HxWxD (INCHES)	LBS
SOLAR RAINMAKER	SOL-K12	4.5 x 5.5 x 2.25	2

Our GRO-TEC™ Walk-In Greenhouses Feature:

- Constructed from durable GRO-TEC™ material. See page 12.
- Full zipper closures and ample screened ventilation.
- Free shade cover and storage bag with shoulder strap.
- Tent stakes and high wind tie-downs.
- Protects plants from wind, frost and snow.
- Screened vents protect against most insects, birds and other pests.
- Lightweight and compact for easy transport and storage.
- Designed to set up on soil hard surface, in or outdoors.
- Open bottom allows for placement over existing plants, beds and containers.
- Accesses for water hose or power cords are integrated in our greenhouse designs.
- Night temperatures inside your FlowerHouse® will drop to outside temperatures without an additional heat source. See page 30 for heating options.
- Makes a beautiful outside sanctuary.



Our walk-in greenhouses include free storage bag with shoulder strap.

PlantHouse 5™

6.5'h x 5'w x 5'd

Easy Pop-Up!



HotHouse™

6.5'h x 6'w x 6'd

Easy Pop-Up!

- Lean-to design fits snugly up to any standard size door of your house, shed or garage.
- Slanted roof ensures precipitation falls away from building.
- Place close to kitchen for easy access to fresh herbs, and veggies.
- Makes a great mudroom!



SpringHouse™

6.5'h x 6'w x 6'd

Easy Pop-Up!



DreamHouse™

6.5'h x 8'w x 8'd

Easy Pop-Up!

- Unique design allows you to zip multiple greenhouses together. Create multiple temperature environments if desired.



End to End Zip Together System!



EXPAND YOUR SPACE WITH 2 OR MORE, USING OUR END-TO-END ZIP TOGETHER SYSTEM

EXTERNAL ZIPPERS

PRODUCT NAME	MODEL#	PART SIZE HxWxD (INCHES)	STORED SIZE H x W (INCHES)	WEIGHT LBS
PLANTHOUSE 5	FHPH155	78 x 60 x 60	28 x 5	26
HOTHOUSE	FHHH350	78 x 72 x 72	36 x 5	35
SPRINGHOUSE	FHSP300	78 x 72 x 72	31 x 7	25
DREAMHOUSE	FHDH500	78 x 96 x 96	38 x 8	35

Flower Forcer / Blackout Slip Covers Fits SpringHouse:
Camo FHSP300FF or Grey FHSP300SHFF:
(sold separately)

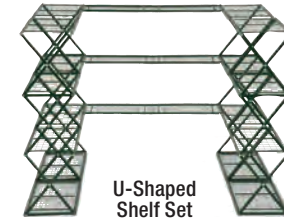

U-Shaped Shelf Set

Fits SpringHouse 6' x 6': #FHSP300SHV
44"h x 72"w x 19"d (sold separately)





End to End Zip Together System!

FarmHouse
8'h x 9'w x 9'd
Easy Pop-Up!



EXPAND YOUR SPACE WITH 2 OR MORE, USING OUR END-TO-END ZIP TOGETHER SYSTEM

PRODUCT NAME	MODEL#	PART SIZE HxWxD (INCHES)	STORED SIZE H x W (INCHES)	WEIGHT LBS
FARMHOUSE	FHFH700	96 x 108 x 108	43 x 8	60
FARMHOUSE XL	FHFH8915XL	96 x 108 x 180	43 x 11	98



Grey Flower Forcer/
Blackout Slip Cover:
(sold separately)
FarmHouse FHFH700SHFF



Camo Flower Forcer/
Blackout Slip Covers:
(both sold separately)
FarmHouse FHFH700FF
FarmHouseXL FHFH8915XLFF



U-Shape Shelf Sets:
(sold separately)
FHFH700SHV
44" h x 108" w x 19" d
Fits FarmHouse 9' x 9'

Large Walk-In Greenhouse Feature:

- Constructed from durable GRO-TEC™ material. See page 12.
- Free shade cover, storage bag with shoulder strap, tent stakes and high wind tie-downs.
- Full zipper closure and ample ventilation.
- Provides optimum environment for seed germination, seedling development and hardening off.
- Protects plants from wind, frost and snow.
- Folds up compact, for easy transport and storage.
- Designed to set up on soil or hard surface.
- Open bottom allows for placement over existing plants, beds and containers.
- Accesses for water hose or power cords are integrated in our greenhouse designs.
- Night temperatures inside your FlowerHouse® will drop to outside temperatures without an additional heat source. See page 30 for heating options.
- Makes a great storage shed for yard equipment and garden tools.



Our walk-in greenhouses include free storage bag with shoulder strap.



FarmHouseXL
8'h x 9'w x 15'd
Easy Pop-Up!

PlantTower™

63”h x 27”w x 19”d

All 3-Covers Included

Vented Spacious Stand Alone Design with 2 buying Options



Exclusive Top Vent For Superior Ventilation



Clear Cover



Shade Cover



Storage/Flower Forcer

PlantTower FEATURES:

- Compact size is ideal for apartments and small decks.
- Clear PVC construction for maximum light and heat transmission.
- Our Easy-Zip exclusive top vent provides superior ventilation.
- Shelves can be easily removed to allow your plants to grow taller.
- Protects plants from wind, frost, snow, insects, birds and other pests.
- Ideal environment for seed starting, propagation, and plant growth
- Makes a great space saving display area for your plants.
- Large zipper door gives you easy access to care for your plants.
- Sets up anywhere, soil or hard surface, indoors or outdoors.
- Greenhouse cover is removable so shelves can have other uses.

PRODUCT NAME	MODEL#	PART SIZE HxWxD (INCHES)	STORED SIZE H x W (INCHES)	WEIGHT LBS
PLANTTOWER 3 cover	FHPT400CL	63 x 27 x 19	27h x 19w x 3d	15
PLANTTOWER 1 cover	FHPT401SC	63 x 27 x 19	27h x 19w x 3d	13

Plant Tower Single Cover

Includes 1-Clear Cover

63”h x 27”w x 19”d



www.flowerhouses.com (810) 686-8252

Here's the Clear Advantage!

Flowerhouse® Clear series greenhouses are beautiful to look at and see through. The Clear material allows more sun and heat through to your plants.

- Open bottom allows for placement over existing plants, beds and containers.
- Full zipper closures and ample ventilation.

- Tent stakes and free storage bag.
- Provides optimum environment for seed germination, seedling development and hardening off.
- Protects plants from wind, frost and snow.
- Lightweight and compact for easy transport and storage.
- Designed to set up on soil or hard surface, in or outdoors.
- Clear PVC construction for maximum light and heat transmission.

- Night temperatures inside your FlowerHouse® will drop to outside temperatures without an additional heat source. See page 30 for heating options.

PRODUCT NAME	MODEL#	PART SIZE HxWxD (INCHES)	STORED SIZE H x W (INCHES)	WEIGHT LBS
SEEDHOUSE JR. CLEAR	FHSD110CL	26 x 30 x 30	14 x 4	5
SEEDHOUSE CLEAR	FHSD100CL	34 x 48 x 48	20 x 4	8
STARTERHOUSE CLEAR	FHSH200CL	34 x 96 x 48	22 x 7	14

SeedHouse Jr Clear™

Easy Pop-Up!

2'h x 2.5'w x 2.5'd

- Maintains 4 seed flats.
- Great for raised beds.
- Compact size is ideal for apartments and small decks.



SeedHouse Clear™

Easy Pop-Up!

3'h x 4'w x 4'd

- Maintains 8 seed flats.
- Great for raised beds.
- Compact size is ideal for apartments and small decks.



StarterHouse Clear™

Easy Pop-Up!

3'h x 8'w x 4'd

- Maintains 16 seed flats.
- 4' x 8' at base.
- Great for raised beds.



Our Clear Series Walk-In Greenhouses Feature:

- Makes a beautiful outside sanctuary.
- Clear PVC construction for maximum light and heat transmission.
- Full zipper closures and ample screened ventilation.
- Free shade cover to diffuse light.
- Free storage bag with shoulder strap.
- Tent stakes and high wind tie-downs.
- Protects plants from wind, frost and snow.
- Screened vents protect against most insects, birds and other pests.
- Lightweight and compact for easy transport and storage.
- Designed to set up on soil or hard surface, in or outdoors.
- Open bottom allows for placement over existing plants, beds and containers.
- Accesses for water hose or power cords are integrated in our greenhouse designs.
- Night temperatures inside your FlowerHouse® will drop to outside temperatures without an additional heat source. See page 30 for heating options.



PlantHouse 5 Clear™

6.5'h x 5'w x 5'd

Easy Pop-Up!



SpringHouseClear™

6.5'h x 6'w x 6'd

Easy Pop-Up!



Free shade cover is included on our walk-in clear greenhouses. Shade cover is recommended for young plants and bright sunny conditions. This helps to diffuse the light that helps plants grow with less stress from heat and direct sun. Shade cloth will also help your greenhouse to last longer. We also recommend storing your greenhouse when not in use.

FarmHouseClear™

8'h x 9'w x 9'd

Easy Pop-Up!



PRODUCT NAME	MODEL#	PART SIZE HxWxD (INCHES)	STORED SIZE H x W (INCHES)	WEIGHT LBS
PLANTHOUSE 5 CL	FHPH155CL	78 x 60 x 60	31 dia x 6	30
SPRINGHOUSE CL	FHSP300CL	78 x 72 x 72	30 dia x 6	50
FARMHOUSE CL	FHFH700CL	96 x 108 x 108	43 dia x 8	60
CONSERVATORY	FHCV900	120 x 104D	35 dia x 10.5	69

Conservatory™

10'h x 9'dia.

- Features include hooks to hang baskets from the roof.

Easy Pop-Up!



Our Architectural-Form Greenhouses Feature:

- Constructed from durable GRO-TEC™ material. See page 12.
- Free storage bag with shoulder strap, tent stakes and high wind tie-downs.
- Free shade cover for OrchidHouse™ and BloomHouse™.
- Provides optimum environment for seed germination, seedling development and hardening off.
- Full zipper closure and ample screened ventilation.
- Protects plants from wind, frost and snow.
- Screened vents protect against most insects, birds and other pests.
- Lightweight and compact for easy transport and storage.
- Designed to set up on soil or hard surface, in or outdoors.
- Open bottom allows for placement over existing plants, beds and containers.
- Accesses for water hose or power cords are integrated in our greenhouse designs.
- Night temperatures inside your FlowerHouse® will drop to outside temperatures without an additional heat source. See page 30 for heating options.
- Other uses include sunroom, storage building, and Spa cover.

BloomHouse™

7'h x 7'w x 7'd

Easy Pop-Up!

OrchidHouse™

7'h x 6'w x 6'd

Easy Pop-Up!

Your FlowerHouse® provides an excellent environment for growing vegetables, flowers, tropical plants, fruiting plants, herbs and spices and also makes a great pond cover for water plants. Other uses include sun room, storage building, and Spa cover.



FlowerHouse®

www.flowerhouses.com (810) 686-8252

Bigger & Better Architectural Designs!

Architectural Form Advantages.

For maximum transmission of radiant energy, the ideal architectural form for a greenhouse is the hemispherical dome. The angle of incidence and the orientation are perfect at all hours of the day. A greenhouse with sidewalls at an angle of 60 to 70 degrees from the horizontal and a roof with a slope of 30 degrees has been found to be more efficient for the transmission of radiant energy than a structure with the same roof slope but with vertical sidewalls (Whittle and Lawrence, 1959). During mid-winter when the sun is relatively low above the horizon, the slanted sidewalls transmit more radiant energy than the vertical sidewalls. FlowerHouse® designed the DomeHouse®, BloomHouse™ and OrchidHouse™ model greenhouses with this design feature in mind.

These greenhouses include free storage bag with shoulder strap.



PRODUCT NAME	MODEL#	PART SIZE	STORED SIZE	WEIGHT
		HxWxD (INCHES)	H x W (INCHES)	
ORCHIDHOUSE	FHOH400	83 x 72 x 72	12 x 54 Long	26
BLOOMHOUSE	FHBH600	84 x 84 x 84	12 x 60 Long	26
DOMEHOUSE	FHD0800	158 dia x 120	16 x 48 Long	47

DomeHouse®

10'h x 13'dia.

Easy Pop-Up!



Sheds To Fit Your Life!

- Storage houses are a unique, cost effective, portable storage solution.
- Compact easy fold design allows for complete set up in minutes.
- Storage houses come with a Weathertuff outer shell.
- Screened vents allow Storage House to breath while keeping pests out.
- Storage Houses fold into their own storage bag when not in use.
- Sets up on soil or hard surfaces.
- Comes complete with integrated floor, screened vents, tent stakes, high wind tie downs and storage bag.



TownHouse

5.5'h x 6.5'w x 2.5'd
Easy Pop-Up!



StorageHouse L

6.5'h x 5'w x 5'd
Easy Pop-Up!



StorageHouse XL

6.5'h x 6'w x 6'd
Easy Pop-Up!

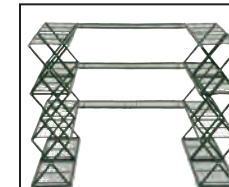

U-Shaped Shelf Set
FHSP300SHV
44" h x 72" w x 19" d
Fits StorageHouseXL
& StorageHouseXXL
6' x 6' (sold separately)



Weathertuff® Design

PRODUCT NAME	MODEL#	PART SIZE	STORED SIZE	WEIGHT
		HxWxD (INCHES)	H x W (INCHES)	
TOWNHOUSE	SHTH562	66 x 78 x 31	22 x 7.5	17
STORAGEHOUSE L	SHSM655	78 x 60 x 60	27 x 11	35
STORAGEHOUSE XL	SHMD766	78 x 72 x 72	27 x 11	52

FlowerHouse

www.flowerhouses.com (810) 686-8252



StorageHouseXXL™

Easy Pop-Up!

8'h x 6'w x 7.5'd

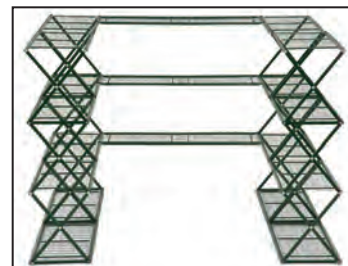

U-Shaped Shelf Set
FHSP300SHV
44"h x 72"w x 19"d
Fits StorageHouseXL
& StorageHouseXXL
6' x 6' (sold separately)

Even More Shed Sizes For All Your Needs!

- Storage houses are a unique, cost effective, portable storage solution.
- Compact easy fold design allows for complete set up in minutes.
- Storage houses come with a Weathertuff® outer shell.
- Screened vents allow Storage house to breath while keeping pests out.
- Storage houses fold into their own storage bag when not in use.
- Sets up on soil or hard surfaces.
- Comes complete with integrated floor, screened vents, tent stakes, high wind tie downs and storage bag.

PRODUCT NAME	MODEL#	PART SIZE	STORED SIZE	WEIGHT LBS
		HxWxD (INCHES)	H x W (INCHES)	
STORAGEHOUSE XXL	SHXL800	96 x 72 x 90	27 x 13	55
STORAGEHOUSE 3XL	SH3XL899	96 x 108 x 108	27 x 16	60

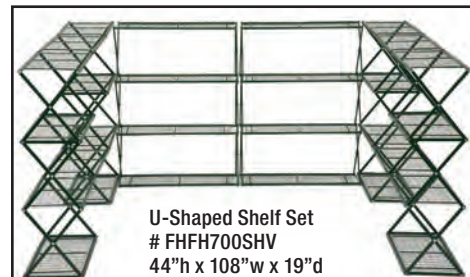

U-Shaped Shelf Set
FHFH700SHV
44"h x 108"w x 19"d
Fits StorageHouse3XL
9' x 9' (sold separately)



Weathertuff® Design

StorageHouse3XL™

8'h x 9'w x 9'd *Easy Pop-Up!*



Our original GRO-TEC™ greenhouses feature GRO-TEC™ exterior sheeting system.

FlowerHouse® greenhouses are constructed with durable GRO-TEC™ material. GRO-TEC™ is UV resistant and features rip stop protection. GRO-TEC™ diffuses or scatters light. Letting in 75% of available light. Diffused light benefits plants both by reducing excess light on upper leaves and by increasing the amount of light reflected onto the lower leaves. See pages 2-5, 9-17, 22-23 for all of our GRO-TEC™ greenhouses.

Special Features That You'll Find Included With Most Of Our Greenhouses:

- Free storage bag with shoulder strap.
- Ground stakes. Walk-in models also include high wind tie-downs.
- Free shade cover to diffuse light.
- Multiple access for water hose or power cords are integrated in our designs.
- Screened vents and doors to protect plants from insects and other pests.



QR Code for FlowerHouse



QR Code YouTube Link



www.flowerhouses.com (810) 686-8252

Some of Our Innovation Awards:

Master Gardeners across the world recognize the function and ease of use of the unique FlowerHouse® Pop-Up designs.



At the largest garden show in the world, in Cologne, Germany, FlowerHouse® was honored for its innovative Pop-Up greenhouse design.



FlowerHouse® Easy Fold Up Instructions for GreenHouses

1. Remove all of the following where applicable, Shade Cloth, Tent Stakes, Fiber Poles, and store them in the storage bag that they came in. (Helpful hint: be sure your unit is clean and dry. Do not put accessories storage bags into main storage pack until greenhouse is fully packed.)
2. Fold your Flowerhouse® from two panels into one as shown in Figure A. (Helpful hint: tuck excess material in between bands so it does not hang out beyond frame edge.)
3. Choose one of the corners. With both hands, fold your Flowerhouse® into a U shape like a giant soft shell taco, folding corner to opposite corner diagonally as shown in Figure B. (Helpful hint: you will feel the tension of the spring steel, this is OK.)
4. As the top corner in your hands meets the diagonally opposite corner on the ground as shown in Figure C, pull or tuck the top corner back under toward your feet, as shown in Figure D. (Helpful hint: as you pull or tuck top corner back UNDER toward your feet you will feel tension release as shown in Figure D.)
5. Then fold the ring on your left side and the right on your right side down over center ring forming three rings, as shown in Figure E. (Helpful hint: the goal is to form three equally sized rings.)
6. This completes the folding of your Flowerhouse® lay it on the ground and kneel or press extra air out that was trapped during folding process, as shown in Figure F.
7. Returning the greenhouse to storage bag works best by holding the folded greenhouse between your knees and then pulling the bag over it, rotating slightly to fit, then pushing the unit in completely, so not to stress the zipper, as shown in Figure G.
8. Now you can place the accessories in their storage bags and next to or between the folded greenhouse. Now greenhouse can be easily stored. (Helpful hint: it is recommended that the greenhouse is then stored out of direct sunlight.)

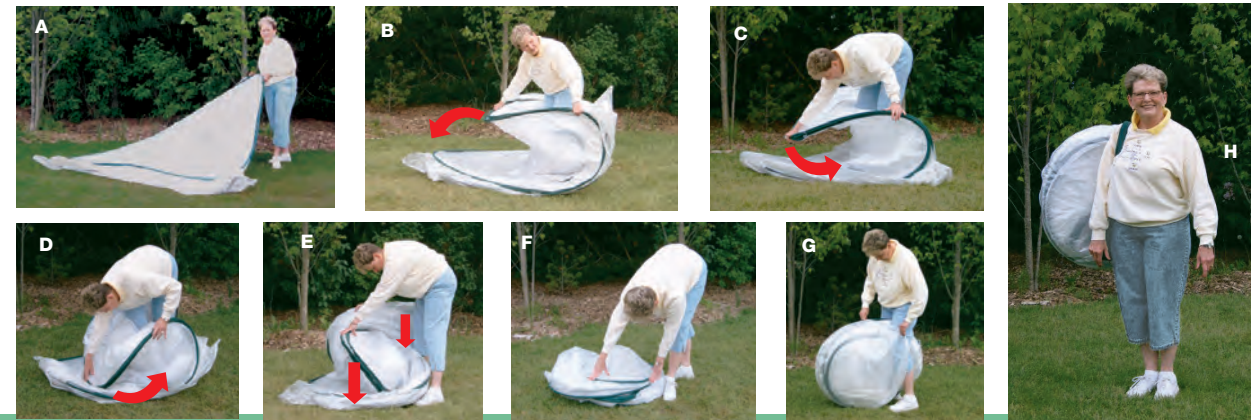

WARRANTY CARD

Send this copy to: FlowerHouse® P.O. Box 595 • Clio, MI 48420-0595

Product Model Number / Name: _____

Date of Purchase: _____ Where Purchased: _____

Print Name: _____

Address: _____

E-mail: _____

My signature below acknowledges that I have read, fully understand, and accept this limited warranty agreement.

Signature: _____

Date: _____

Must return within 14 days of purchase with copy of dated register receipt.

Please make a copy of this for yourself, and mail to: FlowerHouse® P.O. Box 595 • Clio, MI 48420-0595

Greenhouse Gardening Schedule

CHOOSING A LOCATION

Before setting up your FlowerHouse® contact local Miss Dig to establish locations of cables, gas lines and underground wires. Failure to do so could result in serious injury or death while inserting ground stakes. Place your FlowerHouse® on raised, level ground to ensure good drainage. Location should receive maximum sun exposure. Protect your FlowerHouse® from prevailing winds by placing it next to your house, garage or other structure. FlowerHouse® greenhouses are designed to withstand high winds not exceeding 60 mph. Secure all ground stakes and high wind tie downs for maximum stability.

MAXIMIZING SPACE USE

The interior design and layout of your FlowerHouse® will depend on the type and quantity of plants you choose to grow. Plant benches, adjustable shelving and trellises will help you optimize your working space.

MAINTENANCE AND STORAGE

Hose down your FlowerHouse® with a low-pressure sprayer. Mild dish soap may be used. Do not use harsh chemical cleaners. Before storing, ensure that your FlowerHouse® is clean and COMPLETELY DRY. Mold and mildew can grow if it is stored damp.

WATERING

All FlowerHouse® greenhouses feature access ports for your garden hose. Use mist or lowest setting on a hose sprayer. Morning is the best time to water. Avoid watering later in the day to help prevent plant diseases. Check soil for moisture frequently throughout the day, this is especially important in warm weather.

*IDEAL GREENHOUSE TEMPERATURE

The ideal temperatures to maintain inside your greenhouse will be dictated by what plants you have inside. Over wintering tropical plants to starting seeds, remember all plants and seeds have preferred growing and germination requirements. This specific information is readily available at your local garden center, online and in numerous publications.

The DREAMHOUSE™ and FARMHOUSE™ model greenhouses from FLOWERHOUSE®, allow you to zip multiple greenhouses together. This allows you to create multiple climactic environments!

HEATING

The most effective way to heat your FlowerHouse® greenhouse is with a small ceramic heater. There are numerous models on the market, however we recommend you look for a ceramic heater with the following features:

- Automatic overheat shut off.
- Thermostat control. Allows you to set your desired temperature, heater will automatically turn off and on to maintain your set temperature.
- Humidity sensor. Reads percent of humidity in the air. Heaters of this type are readily available at your local stores.
- Placing black weed cloth (not included) on the floor of your greenhouse will absorb heat to keep your greenhouse warmer.
- A large thermal mass, bucket of water or large stones can be placed in your greenhouse to absorb and store heat during the day. At night this stored heat is released, warming your greenhouse. A 55-gallon drum of water works well in the walk in style greenhouses. Placing a heating pad beneath the drum will generate additional warmth. Adjusting the vent openings will change the inside temperature reading. Always use extreme caution when using electrical devices. Keep away from water in case of electrical shock or fire.

COOLING

To lower inside temperature of your greenhouse, open screened vents and doors and attach shade cloth. A fan may also be used.

VENTILATION

It is essential to ensure good air circulation and ventilation year round. Stagnant air and or excessive humidity levels may result in fungus and disease, which can damage your plants.

FALL: Start heating system; ventilate night and day; remove shade cover; keep soil on the dry side; move tender tropical plants into greenhouse for over wintering.

A new garden season starts during the cold brisk days of autumn, but light is at a premium then for there are many cloudy days and the arc of the sun is very low. At this time, plants tend to make soft growth that is susceptible to mildew. Good air circulation is necessary to keep them healthy and disease free. Turn the heat on just as nights become cool (below 40° F), and for short periods when days are damp. Keep vents open throughout the day or roll doors down 6 inches from top. At night close side vents but do not zip tight, roll doors down 1 inch. Although this may seem like a waste of fuel, air circulation is important overnight. In some areas where damp weather prevails, fan heaters are preferable to ceramic as they provide greater air movement. Always use extreme caution when using any heating and/or electrical devices. Don't forget to water! Prepare clean pots, seed flats, and fresh soil for the greenhouse. Winter gardening is more pleasant and productive when supplies are ready for use. Fall is also a great time to start a new compost heap for spring planting. The warm fall rains provide the moisture needed. Freezing and thawing throughout the winter do wonders for soil structure.

WINTER:

On cold nights a common electric heater with fan is recommended. To help heat greenhouse a fan is recommended to keep warm air in motion. Plants like people, can't thrive in poor atmospheric conditions. In bright cold weather, it is easy to keep air fresh. The greenhouse traps more than enough heat from the sun, even though it may be freezing outside. During sunny days, open side vents 1 inch and/or roll down one door 1 inch from top. In the event of very windy weather, close vents and doors on the windward side. Seal completely during heavy snowfall and storms.

Always keep roof clear of snow.

On cold nights, artificial heat keeps air in motion. Leave only a small crack opening in door or vent. During long spells of cloudy weather, you will need to use artificial heat during the day to maintain your ideal temperature. Always use extreme caution when using any heating and/or electrical devices. Placing several pails of water inside your greenhouse can raise humidity. Remember to water!

To extend Greenhouse life, it is recommended that they are taken down when not in use.

Some of the products in this catalog are covered under one or more of the following U.S. Patents: 2,873,671; 2,873,809; 2,891,719; 2,996,718; 3,030,788; 3,030,789; 3,128,323; 3,468,717; 4,338,353; 4,338,354; 4,389,564; 7,614,415; 7,665,478; 12/997381; 13/630,213; 29/443414; 29/454862; 85/734999; 85/936886; D504,519; D505,175; D505,176; D510,972; D511,196; D527786; D533366; D570122; D573801; D602272; D687073 and other patents pending. .

SPRING:

Increase temperature; start feeding schedule; maintain high humidity; attach shade cover. As days become longer, sunlight gets more intense, growth will be noticeably faster and flowering more profuse. Water daily, as required, and maintain a regular schedule of feeding. Hose down floor every morning to make up for evaporation, and to increase humidity. Continue to heat at night if temperature falls below 60° F. Daytime temperatures may run up to 85°F or more by the sun's heat although all vents and doors are open. This will not have a harmful effect. Attach Shade Cover when foliage starts to turn light green and shows signs of wilting under mid-day sun. Keep an eye on your local minimum temperatures to determine when to discontinue night heating. Move/ transplant your plants outdoors **after danger of last frost for your zone has past.**

SUMMER:

If you choose to leave your greenhouse up, most plants can be left in the greenhouse for they are unaffected by high temperatures if sufficient moisture, shade and humidity are maintained. Leave vents and doors open 24 hours a day. Summer is also a great time for propagating cuttings. A great way to multiply your favorite plants. All FlowerHouse® greenhouses can be folded down and stored in minutes at anytime of the year. We highly recommend that you hose off any soil and allow your greenhouse to dry thoroughly before storing. This insures that your greenhouse will be in good condition for its next use.

Your FlowerHouse® greenhouse makes a great storage shed for garden tools, and a convenient shelter for hanging baskets and potted plants during summer storms.



www.flowerhouses.com (810) 686-8252

WARRANTY

Must return within 14 days of purchase with copy of dated register receipt.

FOR BEST PRODUCT LIFE WE RECOMMENDED YOU STORE YOUR FLOWERHOUSE PRODUCT OUT OF DIRECT SUNLIGHT WHEN NOT IN USE.

READ THIS AGREEMENT BEFORE SIGNING THE WARRANTY CARD

This FlowerHouse® product has a limited warranty. No other warranties, whether expressed or implied, including warranties of merchantability and fitness for a particular purpose, apply to the product.

I. GENERAL PROVISIONS OF LIMITED WARRANTY

- A. The original purchaser of this FlowerHouse® product is warranted against defects in material and workmanship for ONE year following the date of its retail purchase.
- B. The exclusive remedy for defects in material and workmanship under the warranty is replacement or repair at FlowerHouse's® expense.
- C. FlowerHouse® will, at its option, repair or replace products not conforming to this limited warranty at no charge. This is the sole and exclusive remedy available under any legal theory for this FlowerHouse™ product.
- D. Customer is responsible for all shipping and handling charges involved with warranty fulfillment.

II. NO OTHER WARRANTIES

No other warranties, whether expressed or implied, including warranties of merchantability and fitness for a particular purpose, shall apply to the product.

III. EXCLUSIONS, LIMITATIONS, AND CONDITIONS OF LIMITED WARRANTY

- A. This warranty cannot be assigned or transferred.
- B. This warranty only applies if the FlowerHouse® product is used in accordance with FlowerHouse's® written instructions.

- C. FlowerHouse® products are intended only for gardening. FlowerHouse™ products are not intended or authorized for use in any situations that may create health or injury risks.
- D. This warranty is void if the product is damaged through abuse, accident, improper use, negligence, or normal wear and tear.
- E. This warranty is void if the product is altered, changed or modified in any manner.
- F. This warranty is void if any attempt is made to repair the product without written authorization from FlowerHouse®.
- G. Except as provided in this limited warranty, all FlowerHouse® products are provided "as is." All other warranties and representations, oral or written, expressed or implied, including but not limited to any implied warranties of merchantability or fitness for a particular purpose, are excluded and do not apply.

IV. PROCEDURES IN EVENT OF DEFECT

- A. If you find a product to be defective, contact FlowerHouse®, Box 595, Clio, MI 48420; phone: (810) 686-8252; fax: (810) 686-5492.
- B. When you receive authorization from FlowerHouse®, return the product as directed by FlowerHouse®.

V. LIMITATION OF DAMAGES

- A. FlowerHouse® shall not, under any circumstances or legal theory, be liable or responsible for direct, indirect, special, incidental, or consequential damages.
- B. FlowerHouse® shall not, under any circumstances or legal theory, be liable or responsible for any amount in excess of the product purchase price.

- C. FlowerHouse® shall not, under any circumstances or legal theory, be liable or responsible for damage to items or equipment used with the FlowerHouse® product.
- D. FlowerHouse® shall not, under any circumstances or legal theory, be liable for personal injury, personal loss, lost profits, lost wages, goodwill, downtime, economic loss in excess of the product purchase price, or any non-economic damages.

VI. ADDITIONAL PROVISIONS

- A. This agreement is the entire agreement between you and FlowerHouse®. This agreement supersedes any prior or different agreements, representations, or proposals, whether written or oral.
- B. No representative, agent or employee of FlowerHouse® is authorized to make warranties, representations, or obligations other than those set forth in this limited warranty.
- C. This agreement may only be changed through an express written agreement with FlowerHouse®.
- D. Waiver by any party of any default or breach of this agreement will not constitute a waiver of any subsequent default or breach of the same or different kind.
- E. If any section or provision of this agreement is found to be invalid, such invalidity does not affect or extend to other sections or provisions in this agreement.
- F. This warranty gives you the specific legal rights. You may also have other rights that vary from state to state. This agreement shall be governed by the laws of the State of Michigan, United States of America.