

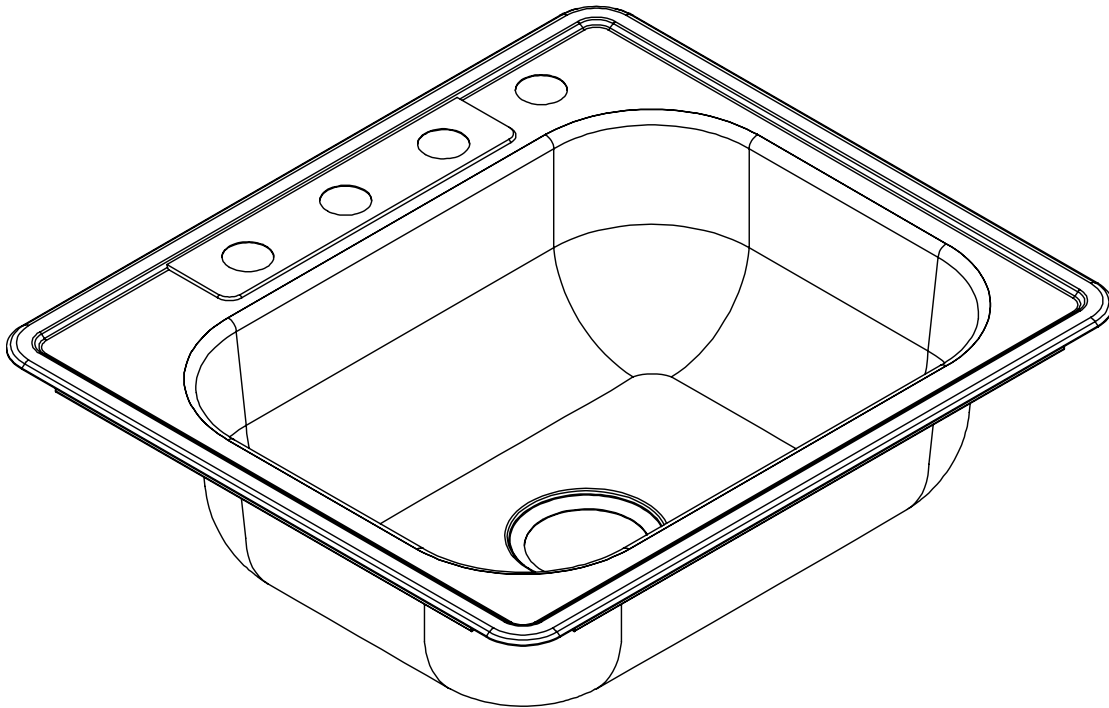

Item # 114-559
Model # HDSB252284

USE AND CARE GUIDE

STAINLESS STEEL SINGLE BOWL KITCHEN SINK



Questions, problems, missing parts? Before returning to the store,
call Glacier Bay Customer Service
8 a.m. - 7 p.m., EST, Monday-Friday, 9 a.m. - 6 p.m., EST, Saturday

1-855-HD-GLACIER

HOMEDEPOT.COM/GLACIERBAY

THANK YOU

We appreciate the trust and confidence you have placed in Glacier Bay through the purchase of this kitchen sink. We strive to continually create quality products designed to enhance your home. Visit us online to see our full line of products available for your home improvement needs. Thank you for choosing Glacier Bay!

Table of Contents

Table of Contents	2	Hardware Included	3
Safety Information.....	2	Package Contents	3
Warranty	2	Installation	4
Pre-installation	3	Care and Cleaning	5
Planning Installation	3		
Tools required	3		

Safety Information

1. Your installation must comply with all local plumbing building codes. Have a qualified tradesman do or approve your plumbing installation.
2. Please carefully read this guide before installing or using this product. Store this guide in a safe place so you will know where it is when you want to refer to it.



WARNING: Risk of personal injury. Metal surfaces are sharp and can cause severe cuts. Use gloves and handle sink edges carefully.

Warranty

LIMITED LIFETIME WARRANTY

Glacier Bay products are manufactured with superior quality standards and workmanship and are backed by our limited lifetime warranty. Glacier Bay products are warranted to the original consumer purchaser to be free of defects in materials or workmanship. We will replace FREE OF CHARGE any product or parts that proves defective. Simply, return the product / part to any of The Home Depot retail locations or call 1-855-HD-GLACIER (1-855-434-5224) to receive the replacement item. Proof of purchase (original sales receipt) from the original consumer purchaser must be made available for all Glacier Bay warranty claims.

This warranty excludes incidental/inconsequential damages and failures due to misuse, abuse or normal wear and tear. This warranty excludes all industrial, commercial & business usage, whose purchasers are hereby, extended a five year limited warranty from the date of purchase, with all other terms of this warranty applying except the duration of warranty.

Some states and provinces do not allow the exclusion or limitation of incidental or consequential damages, so the above limitations may not apply to you. This warranty gives you specific legal rights and you may also have other rights that vary from state to state and province to province. Please see a store or contact 1-855-HD-GLACIER for more details.

Contact the Customer Service Team at 1-855-HD-GLACIER or visit www.HomeDepot.com/GlacierBay.

Pre-installation

PLANNING INSTALLATION

Compare all parts with the Hardware Included and Package Contents lists in this manual. Check the surface of the sink for any flaws or damage, including dents, bends, or scuff marks. If any damage is noticed or parts are missing, do not proceed with the installation. Contact the Customer Service Team at 1-855-HD-GLACIER or visit www.HomeDepot.com.



NOTE: This sink is a top mount installation only.

TOOLS REQUIRED



Safety goggles



Gloves

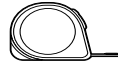

Tape Measure

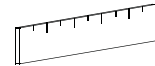

3 ft. Straightedge

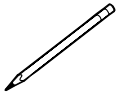

Pencil



Drill

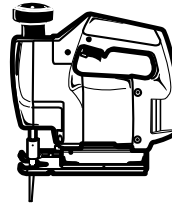

Saber saw or Jig saw

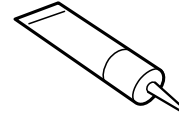

Silicone sealant



Flashlight

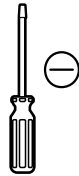

Flathead screwdriver



Pipe wrench



Wrenches (2)

HARDWARE INCLUDED



NOTE: Hardware not shown to actual size.

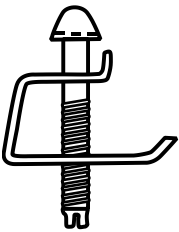

___AA

PACKAGE CONTENTS

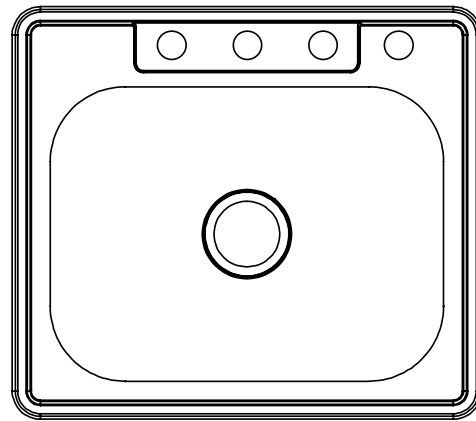

___A

Part	Description	Quantity
AA	Top Mount Clip	12

Part	Description	Quantity
A	Top Mount Sink	1

Installation

1 Preparing the countertop

- Position the sink (A) upside down on the countertop.
- Trace completely around the edge of the sink (A).
- Draw a line 5/16 in. inside of the outline of the sink.

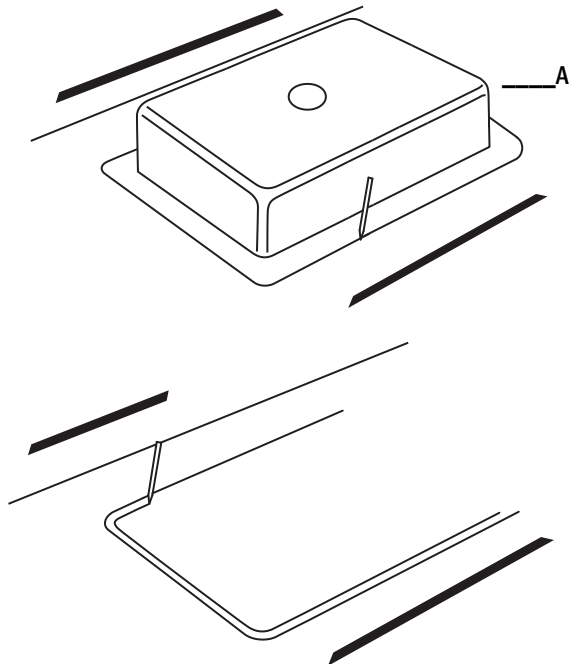

2 Cutting the counter



WARNING: Always wear safety goggles and gloves when using power tools to prevent personal injury

- Drill a pilot hole in all four corners of the inside line.
- Use a saber saw or jig saw to cut on the inside line.
- Place a support underneath the cutout portion of the countertop to prevent it from falling during cutting.

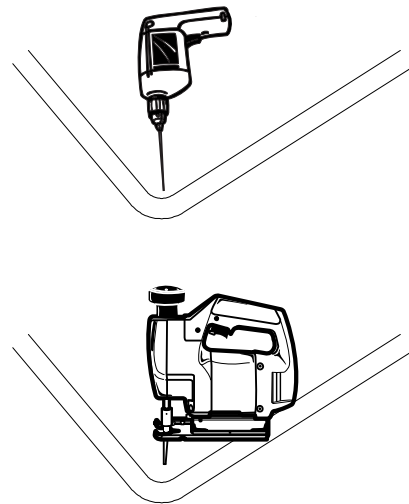

3 Installing the sink

- Apply silicone sealant (not included) around the cutout on the countertop surface.
- Carefully lower the sink (A) into the cutout in the countertop.
- Preassemble the clamps and screws (AA).
- From the underside - place a clamp (AA) in the center along each side and hand tighten to hold sink in place. Fasten the remaining clamps (AA) along the edges and space them approximately 3 in. from each end, and equally along the front, back, and sides. For countertops thicker than 3/4 in. space them up to 1-1/2 in. apart.
- From the top - check the seal between the sink (A) edge and countertop. Adjust clamps (AA) if necessary.
- Lightly tighten clamps (AA) evenly with a screwdriver until the sink is perfectly tight to the countertop. **Do not over tighten.**
- Wipe away any excess sealant with a rag.

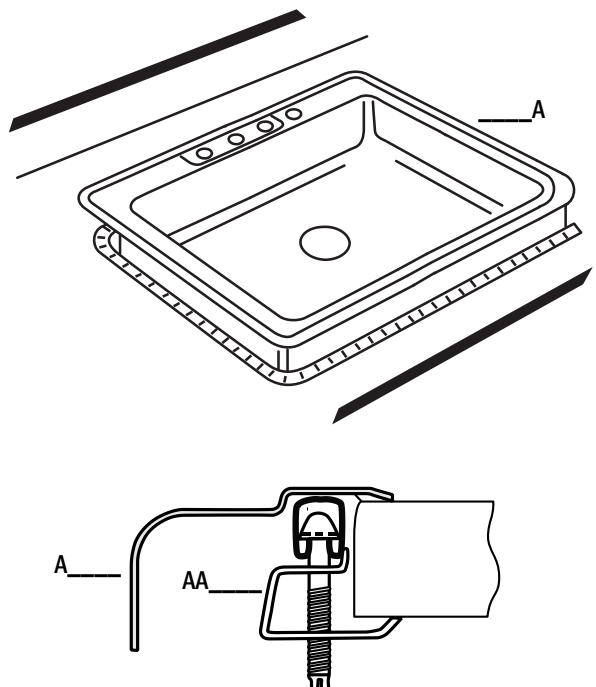

Care and Cleaning

- Daily, regular cleaning to remove dirt and prevent staining is recommended. Use liquid dish detergent, water and a soft household sponge.
- Mild, non-abrasive cleaners can be used with a nylon scrub pad. To ensure a uniform appearance in a stainless steel sink surface, rinse with water and wipe down the sink with a soft, dry cloth. Drying the sink will prevent water spots caused by time in the water.
- Remove stubborn stains from lime or calcium deposits by pouring a little warm vinegar or vinegar-based cleaner into the sink and allow it to sit for a few minutes. Rinse with clean water and dry.
- Scratches are inevitable during your usage over time. Use a nylon pad with an iron free abrasive polishing compound. Follow the original polish lines to blend out the scratch in a small area. Be careful not to overdo as aggressive scrubbing will result in a bright spot.
- DO NOT use strong abrasive cleaners, metal scrub pads, or steel wool. These will scratch the surface.
- DO NOT leave rubber mats or sponges inside the sink. Water trapped below could lead to stains.
- DO NOT let food with a high salt content sit inside the sink for prolonged periods of time.
- DO NOT use chlorine bleach or chlorinated cleaning products on the sink surface.
- DO NOT allow drain cleaners to come into contact with the sink surface.
- DO NOT pour paint in your sink. The chemicals in acrylic paint will react with sinks if allowed to sit over 24 hours and will produce permanent marks. For latex based paints, remove any residue immediately using a paint remover manufactured by the same brand. Consult the paint remover recommendations before using on the sink. For all sinks, we also recommend nail polish remover, rubbing alcohol or an acetone based paint remover to eliminate paint residue.
- Rust spots - Stainless steel does not rust. Rust stains are the result of iron particles introduced by water, cookware, and steel wool pads that react with water to create rust. Metal cleaners will remove rust spots.



Questions, problems, missing parts? Before returning to the store,
call Glacier Bay Customer Service
8 a.m. - 7 p.m., EST, Monday-Friday, 9 a.m. - 6 p.m., EST, Saturday

1-855-HD-GLACIER

[HOMEDEPOT.COM/GLACIERBAY](https://www.homedepot.com/glacierbay)

Retain this manual for future use.