

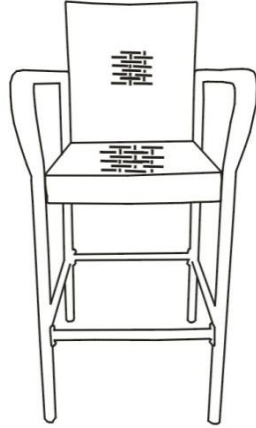



Assembly Instructions

Caution : You must read this before you proceed



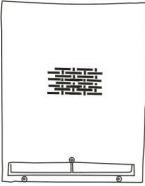

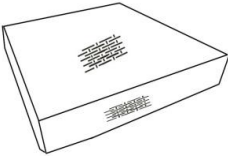

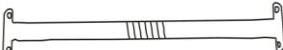
Barstool



Parts List

Label	Picture	Description	QTY
A		Backrest	1
B		Left Armrest	1
C		Right Armrest	1
D		Seat Panel	1
E		Front Foot Rest	1
F		Back Foot Rest	1

Hardware

Label	Picture	Description	QTY
G		Allen Key	1
H		Bolt (M6*45MM)	5
I		Bolt (M6*35MM)	6
J		Bolt (M6*20MM)	9
K		Bolt Cap	13
L		Washer	20

Assembly Preparation

Before Beginning Assembly:

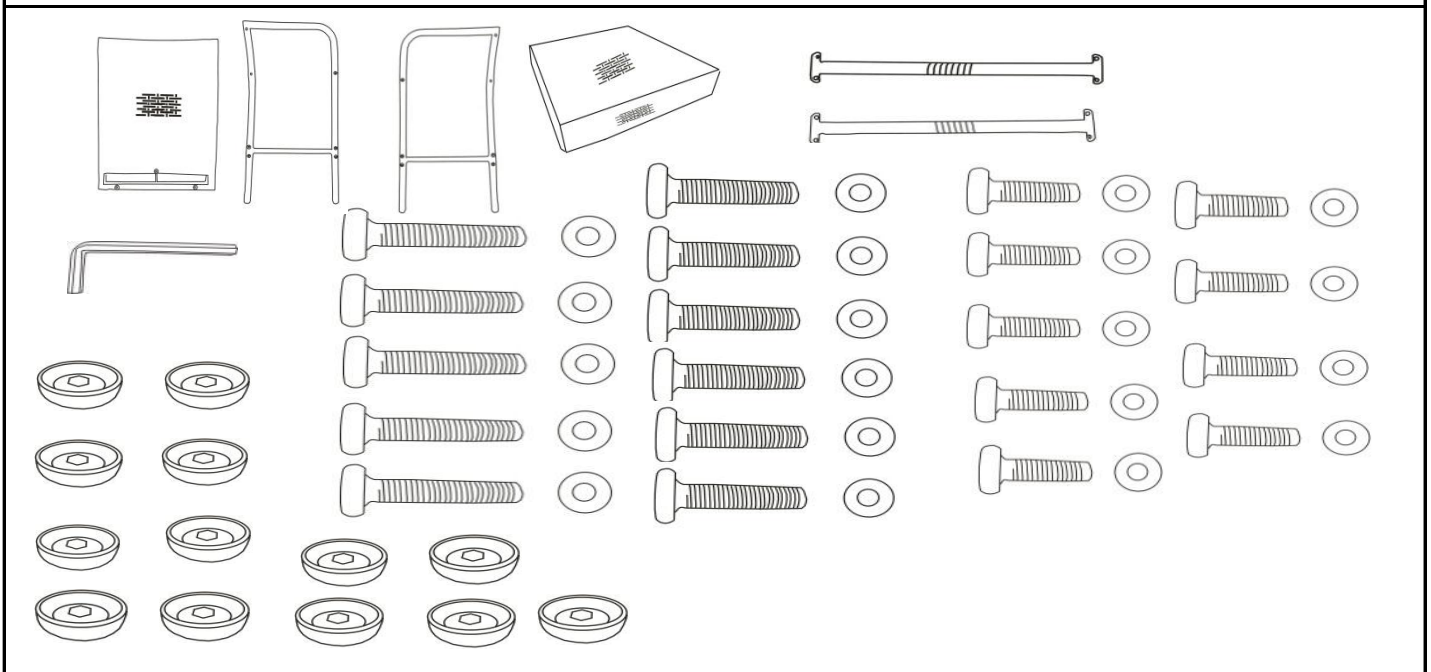

- Read instructions, cover to cover-



- Have 2 adults on hand for assembly-



- Do not assemble on flooring or carpet-



- Assemble on a clean non-marring surface (packing foam)-



- Save all packaging until finished-

Assembly Steps

Overview

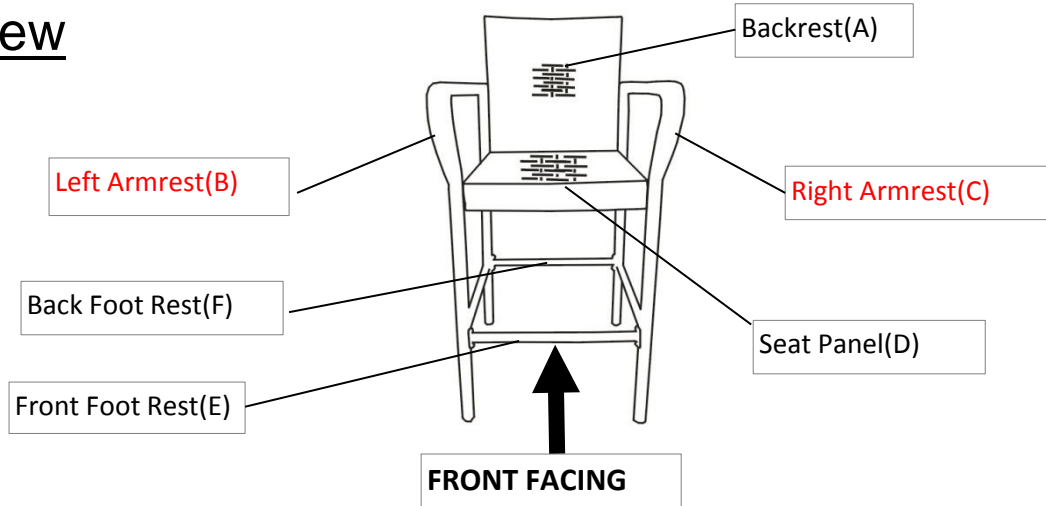

This Barstool has multiple parts and may require up to **30** minutes to assemble. To give you an overview of the Barstool parts, the above picture is to help you put the various parts into perspective. Please read through the instructions herebelow to familiarise yourself with the parts and steps before assembly.

Step 1

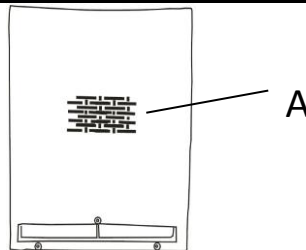

Open the carton and place all the parts onto a clean, non-marring surface. Place Backrest(A) on the ground, as shown in picture above.

Step 2

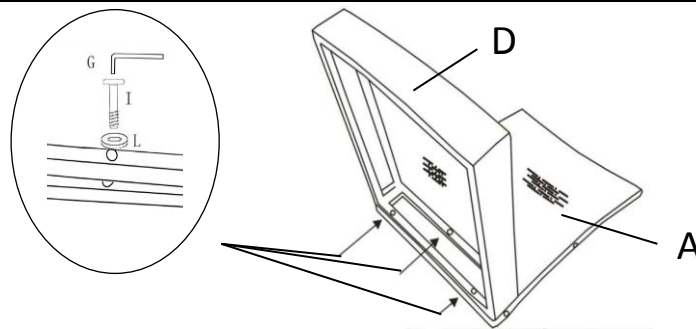

Attach Seat Panel(D) to Backrest(A) using Bolts(I) and Washers(L) with Allen Key(G).

DO NOT FULLY TIGHTEN THE BOLTS.

ATTENTION: Occasionally some of the PE Wicker shifts and covers the mounting positions preventing easy assembly; The PE Wicker should never be cut, but moved away from the mounting positions.

Step 3

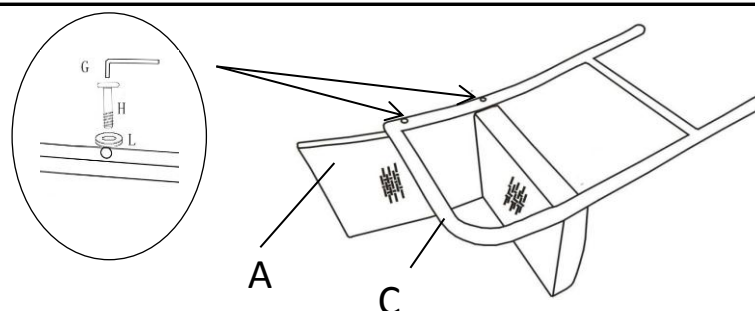

Attach the Right Armrest(C) to Backrest(A) using Bolts(H) and Washers(L) with Allen Key(G).

DO NOT FULLY TIGHTEN THE BOLTS.

Step 4

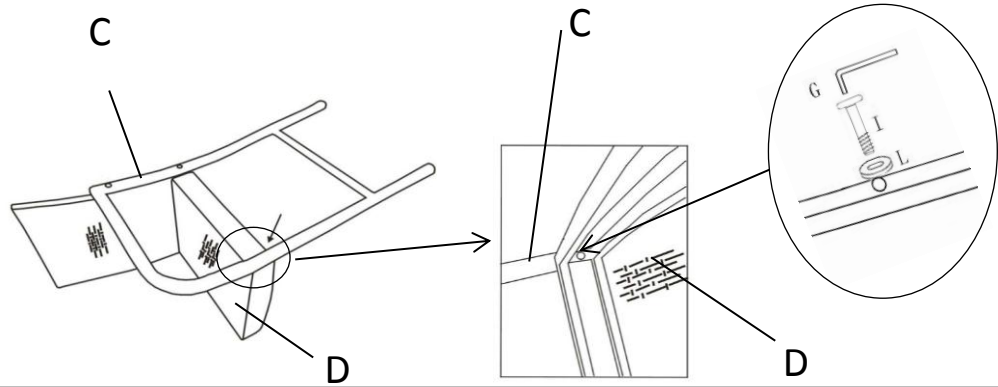

Attach the Right Armrest(C) to Seat(D) using Bolt(I) and Washer(L) with Allen Key(G).
DO NOT FULLY TIGHTEN THE BOLTS.

Step 5

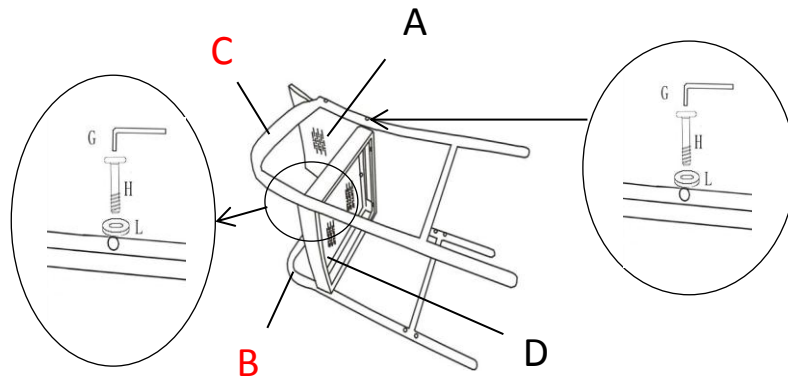

Turn the partially assembled chair 180°, to allow you to affix the other arm panel.
Repeat Steps 3 and 4 to assemble Left Armrest(B).
DO NOT FULLY TIGHTEN THE BOLTS.

Step 6

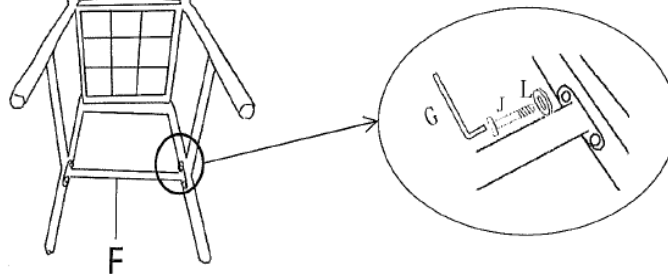

Attach the Back Foot Rest(F) between the back legs using Bolts(J) and Washers(L) with Allen Key(G).
DO NOT FULLY TIGHTEN THE BOLTS.

Step 7

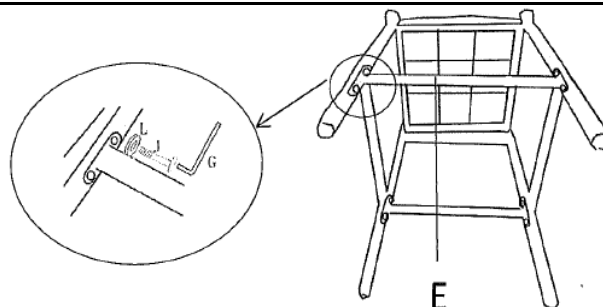

Attach the Front Foot Rest(E) between the front legs using Bolts(J) and Washers(L) with Allen Key(G).
DO NOT FULLY TIGHTEN THE BOLTS.

Step 8

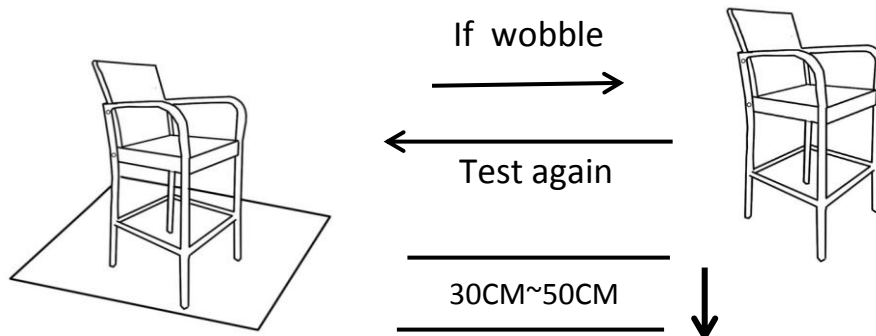

Place the barstool on a **LEVEL SURFACE** to check for wobbles.

If it wobbles lift the barstool to some 30cm to 50cm height from the ground.

Keep your feet and toes well away from the drop zone.

Drop the barstool freely and vertically with the four legs, hitting the ground, all at the same time.

This Drop Test will help to ensure that all the bolts and gaps to all reach full alignment status.

Test again for evenness on a **LEVEL SURFACE**.

If no wobbles found, slowly and steadily turn the barstool upside down.

Then, proceed to tighten all bolts in a sequential manner.

CAUTION : When tightening these bolts, tighten sequentially.

DO NOT tighten any screw fully and then towards the next one.

This would cause the frame to warp.

If there is still wobbles, loosen the bolts and execute this same drop tests.

WARNING!! IF BARSTOOL IS NOT STABLE , IT COULD LEAD TO DAMAGING THE PRODUCT.

Step 9

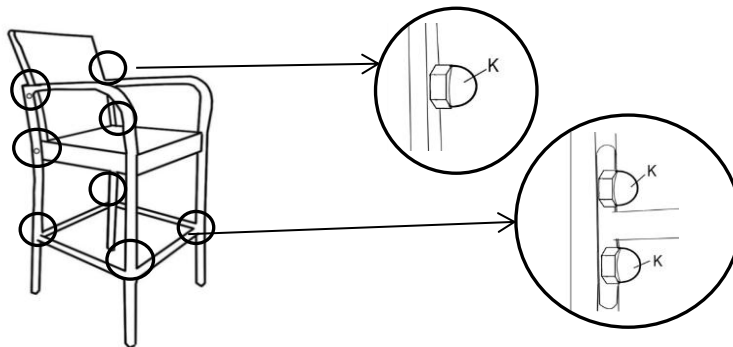





















Add the Bolt Caps(K) on the 12 Bolts as shown in the picture above.

Step 10



Your Barstool is ready for use.

Care & Maintenance

-   ● Do not put hot items directly on furniture surface
 -   ● Do not clean furniture with harsh cleansers or polish.
 -   ● To obtain the longest lifespan of your outdoor products, minimizing exposure to direct sunlight is recommended.
 -   ● Children should not climb or jump on the furniture.
 -   ● Do not write on furniture without a padded barrier to protect the surface.
 -   ● To obtain the longest lifespan of your outdoor products, avoid extended and lengthy exposure to rain, snow, and direct sunshine. Whenever possible cover the product and /or place under patio or awnings.
 -   ● Not for commercial use. For residential use only .
 -   ● Stains may be removed with mild soap solution and damp cloth.
 -   ● Keep away from sources of ignition.
-
-   ● Dust and pick-up spills using a clean, non-colored, lint-free cloth .

What is Proposition 65?

Proposition 65 is a California law that requires warning labels on products that may contain one of more than 800-plus chemicals or ingredients that the California Office of Environmental Health Hazard Assessment (OEHHA) has deemed to cause cancer or other reproductive toxicity. Chemicals and elements on this list include wood dust, brass, and other everyday substances, which can be found in very common household items, such as: lamps, tableware, jewelry, crystal glasses, electric cords, beauty products, automobiles, and furniture.

Why Did I Find a Proposition 65 Warning on My Home Goods Product?

We include Proposition 65 warnings on all of our products because there is always a chance that one of the 800-plus common chemicals and ingredients listed under this law could potentially be on our furniture or packing materials. We risk large fines under this law, if we don't include this warning.

Should I worry?

We realize you may be worried finding this warning on our products, but we want to reassure you that the hazardous exposure limits for any of these chemicals have never been found on furniture products that we've shipped to our customers. Additionally, this warning label is very common and can be found on almost every piece of furniture sold in the state of California.

Just How Common Are Proposition 65 Warnings?

Proposition 65 warnings have become so common in California that it is hard to take a trip to a local bank, grocery store, or restaurant without finding at least one warning. In fact, even the Disney Land Resort has a Proposition 65 warning:

