

NINJA

COFFEE BAR®

CF091 series

OWNER'S GUIDE



ninjacoffeebar.com
1-877-646-5288

IMPORTANT SAFEGUARDS

For Household Use Only

READ ALL INSTRUCTIONS BEFORE USING YOUR NINJA COFFEE BAR®.

Safety Signal Words

This manual and the safety labels attached to this appliance utilize signal words that signify safety hazards with different levels of severity.

Below are the words used and the definitions for these words:

- **WARNING** indicates a hazardous situation which, if not avoided, could result in death or serious injury.
- **CAUTION** indicates a hazardous situation which, if not avoided, could result in minor or moderate injury.
- **NOTICE** is used to address practices not related to physical injury.

The words “**WARNING**” and “**CAUTION**” are preceded by a triangle signifying that these are safety-related.

The terms “**IMPORTANT**” and “**NOTE**” are also used to describe good ideas for better and more efficient equipment use.

THIS BOOK COVERS MODEL NUMBERS:

CF090A
CF090CO
CF091
CF092W

TECHNICAL SPECIFICATIONS

Voltage: 120V~, 60Hz.
Power: 1450 Watts
Water Reservoir
Capacity: 50 Ounces

Ninja and **Ninja Coffee Bar** are registered trademarks of SharkNinja Operating LLC.

⚠️ WARNING:

To reduce the risk of fire, electric shock, serious injury, death or damage when using this appliance, follow these basic safety precautions.

General Precautions

- 1 **DO NOT** allow young children to operate the appliance or use as a toy. Close supervision is necessary when any appliance is used near children.
- 2 To reduce the risk of electric shock, this appliance has a polarized plug (one blade is wider than the other). As a safety feature, this plug will fit into a polarized outlet only one way. If the plug does not fit fully into the outlet, reverse the plug. If it still does not fit, contact a qualified electrician. **DO NOT** force into outlet or try to modify to fit.
- 3 To protect against electrical shock, **DO NOT** submerge the appliance or allow the power cord to come into contact with water or any other liquid.
- 4 Allow the appliance to cool before taking off parts and before cleaning.
- 5 **NEVER** carry the appliance by the power cord or yank it to disconnect from electrical outlet; instead grasp the plug and pull to disconnect.
- 6 **DO NOT** operate any appliance with a damaged cord or plug, or after the appliance malfunctions, or has been dropped or damaged in any manner.
- 7 **DO NOT** let the power cord hang over the edge of table or counter or touch hot surfaces such as the stove.
- 8 Extension cords are not recommended for use with this product.
- 9 **DO NOT** remove the brew basket or carafe while the appliance is brewing. **Scalding may occur if any of these parts are removed during brewing cycles.**

- 10 The use of an accessory not recommended by the manufacturer may create an overflow condition and scalding hazard, or result in fire, electric shock, or personal injury.
- 11 **DO NOT** operate your appliance in an appliance garage or under a wall cabinet. When storing in an appliance garage always unplug the unit from the electrical outlet. Not doing so could create a risk of fire, especially if the appliance touches the walls of the garage or the door touches the unit as it closes.

Operating Notice

- 12 **DO NOT** use well water, use tap water.
- 13 Clogging and backing up of water and/or coffee in the filter basket can occur under any of the following conditions: The use of coffee that is too finely ground; using two or more paper filters; using a permanent filter in conjunction with a paper filter; not cleaning coffee grounds from a permanent filter; or allowing coffee grounds to spill over the filter.
- 14 **ALWAYS** use appliance on a dry, level surface.
- 15 **DO NOT** place on or near a hot gas or electric burner, or in a heated oven.
- 16 **DO NOT** use this appliance for anything other than its intended use. **DO NOT** use outdoors.
- 17 **DO NOT** touch hot surfaces. Use handles or knobs.
- 18 **DO NOT** touch warming plate while the brewer is in use.
- 19 **DO NOT** reach across top of brewer to froth during brewing. Steam is released from vent on top of brewer and can result in a steam burn.

Glass Carafe

- 20 The carafe is designed for use with this appliance. It must never be used on a range top.
- 21 **DO NOT** set a hot carafe on a wet or cold surface.
- 22 **DO NOT** use a cracked or scratched carafe or a carafe that has a loose or weakened handle.

- 23 **DO NOT** clean carafe with abrasive cleansers, steel wool pads, or other abrasive material.
- 24 **DO NOT** place carafe in microwave.
- 25 **DO NOT** expose carafe to extreme temperature changes.
- 26 **DO NOT** place on or near a hot gas or electrical burner, or in a heated oven.
- 27 **DO NOT** use for carbonated beverages.
- 28 **DO NOT** drink directly from the carafe. Liquid from the carafe may be very hot.
- 29 **DO NOT** use the carafe to store any other type of food when not in use.
- 30 Ensure that the carafe is completely empty before starting a cleaning or brewing cycle. Starting a cycle with water or coffee in the carafe will cause an overflow.
- 31 To prevent illness from bacterial growth in the appliance, follow all cleaning instructions in the “Care & Maintenance” section of this owner’s guide.

Maintenance

- 32 Remove the power cord from the electrical outlet and allow unit to cool before removing brew basket, water reservoir, or filters before surface cleaning.
- 33 If the product is not operating properly contact SharkNinja Operating LLC at 1-877-646-5288 or ninjacoffeebar.com for examination, repair or adjustment.
- 34 Clean the system on a weekly basis.

Cord Statement

- 35 A short power-supply cord is provided to reduce the risks resulting from becoming entangled in or tripping over a longer cord.
- 36 **DO NOT** use extension cords with this product.

SAVE THESE INSTRUCTIONS

Contents

Thank you for purchasing the Ninja Coffee Bar®.

Getting To Know Your Ninja Coffee Bar	4
Control Panel	5
Features Of The Ninja Coffee Bar	6
Before First Use	7
Setting The Clock and Delay Brew	8
Assembly	9
Preparing and Using the Ninja Coffee Bar	11
How Much Coffee Do You Get In Your Cup?	11
Would You Like A Hotter Coffee?	11
Pre-Heating	11
Filling The Brew Basket With Coffee	12
Drip Stop	13
Intelligent Warming Plate	13
Brewing Coffee	14
Classic and Rich Brew	14
Over Ice Brew	15
Signature Brews: Specialty and Cafe Forte Brew	15
Frothing Your Milk	16
Care & Maintenance	17
Cleaning After A Brew	17
How To Clean & Descale The Brewing System	18
Troubleshooting Guide	19
Replacement Parts	21
Warranty & Registration	22

Getting To Know Your Ninja Coffee Bar®

⚠ CAUTION: DO NOT reach across top of brewer to froth during brewing. Steam is released from vent on top of brewer and can result in a steam burn.

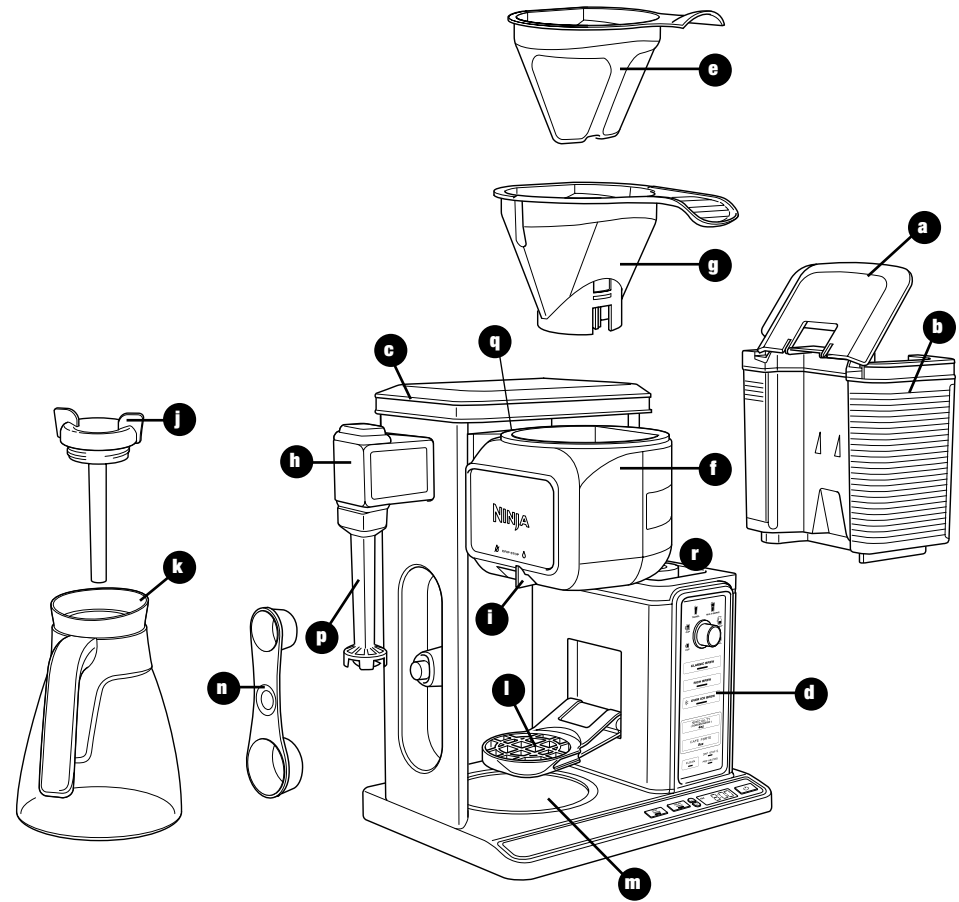

- a** Flip-Top Water Reservoir Lid
- b** Removable Water Reservoir
- c** Brewer
- d** Control Panels
- e** Permanent Filter
- f** Swinging Brew Basket
- g** Removable Filter Holder
- h** Integrated Frother
- i** Drip Stop Toggle

- j** Brew-through Carafe Lid
- k** Glass Carafe
- l** Multi-Serve Cup Platform
- m** Intelligent Warming Plate
- n** Double-Sided Scoop: Carafe Side and Single Serve Side
- o** Power Cord & Wrap (not shown)
- p** Frother Whisk
- q** Showerhead
- r** Water Tank Shelf

Control Panel

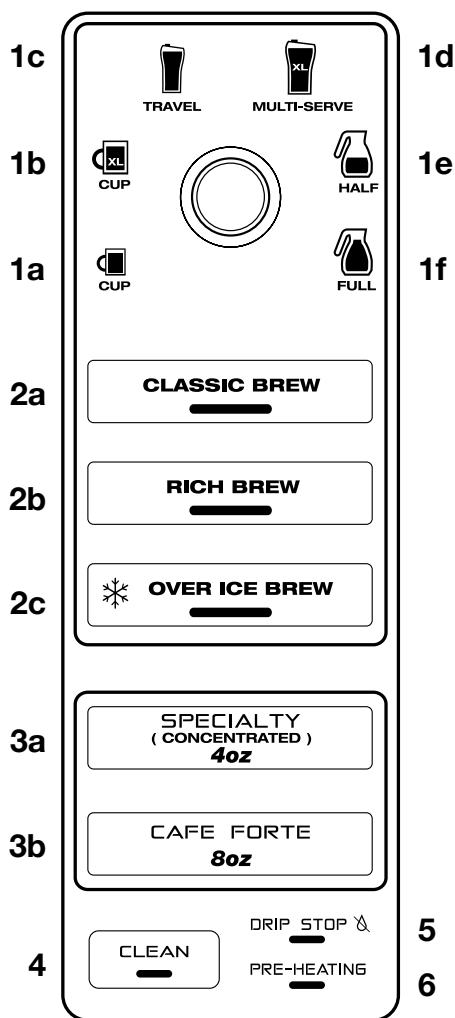

- 1 Multi-Serve Dial
 - a Cup
 - b XL Cup
 - c Travel Mug
 - d XL Multi-Serve
 - e Half Carafe
 - f Full Carafe
 - 2 Custom Brew Types
 - a Classic Brew Button
 - b Rich Brew Button
 - c Over Ice Brew Button
 - 3 Ninja® Signature Brews
 - a Specialty Brew Button
 - b Cafe Forte Brew Button
 - 4 Intelligent Clean Cycle Indicator/Button
 - 5 Drip Stop Indicator
 - 6 Pre-Heat Indicator
- Secondary User Interface**
- 7 Stay Warm Button
 - 8 Delay Brew Button
 - 9 Clock Hour and Minute Buttons
 - 10 Programmable Digital Clock
 - 11 Power Save Button

7 8 9 10 11

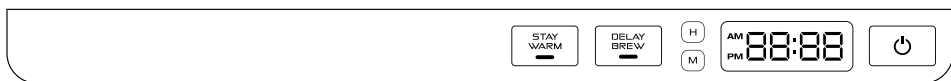

Features of the Ninja Coffee Bar®

- **Thermal Flavor Extraction® Technology** - Blends Precision Water Delivery with automated controls for Calibrated Temperature, Pre-infusion, Coffee Saturation, and Flavor Richness. Ninja's Advanced Thermal Flavor Extraction technology can truly unlock the full flavor potential of your coffee.
- **Custom Brews** – Ability to brew directly into your favorite cup, travel mug, or carafe.
- **Brew Types** – Control the strength and style of your coffee:
 - a. Classic Brew for smooth, balanced flavor from your favorite coffee.
 - b. Rich Brew for a richer, never-bitter coffee flavor that stands up to milk, cream, or flavoring.
 - c. Over Ice Brew for a smooth, rich, freshly brewed iced coffee that's not watered down.
 - d. Specialty Brew to create a super-rich concentrate to use as a key ingredient in all kinds of hot milk-based, iced, and frozen coffeehouse-style drinks.
 - e. Cafe Forte for deep, full-bodied, and complex flavor that is so rich and drinkable, it tastes great black—no milk or sweeteners needed.
- **Multi-Serve Cup Platform** – Pull it down, place your favorite cup on it and brew directly into it.
- **Removable Water Reservoir with Easy Access Flip-Top Lid** – For quick and easy filling.
- **Auto-iQ™** – The Ninja Coffee Bar knows how much water to use for each size and brew type.
- **50 oz. Glass Carafe**
- **LED Control Panels with Programmable Digital Clock**
- **24-Hour Programmable Delay Brew Button** – Set it to automatically brew the following morning.
- **Drip Stop** – Stops the flow of coffee from the brew basket, allowing you to pour a cup mid-brew; switch toggle to the closed position to prevent dripping once the brew cycle is finished.
- **Clean Function** – It illuminates when your Ninja Coffee Bar senses that there is hard water calcium buildup in your brewer which can affect the flavor of your coffee. When it illuminates, follow the cleaning instructions in the Care & Maintenance section or printed on the back of your brewer.
- **Stay Warm Button** – Your warming plate will automatically turn on after brewing a carafe and turn off after 2 hours. The Stay Warm button allows you to manually turn the warming plate off.
- **Intelligent Warming Plate** – Automatically adjusts the temperature of the warming plate to keep your coffee at the ideal drinking temperature without burning it.
- **Audible Ready Signal** – Alerts you that your coffee is ready.
- **2 hour shut off** – Automatically turns off the warming plate two hours after you brew coffee.
- **Permanent Filter** - The permanent filter is a reusable filter that preserves the natural coffee oils and small coffee particles to provide a robust flavor, similar to what you would experience when using a French press.
- **Pre-Heat** - After plugging in or turning your brewer on from Power Save mode, allow 3 minutes for your brewer to pre-heat. When plugged in, your Ninja Coffee Bar will stay ready in pre-warmed mode unless you put the brewer into power save mode.

Go to ninjacoffeebar.com for more information and how-to videos.

Brew into a cup or travel mug

Cup or XL Cup

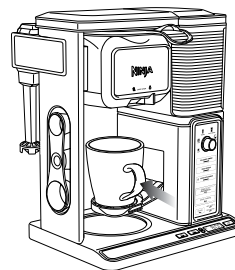

Travel Mug & XL Multi-Serve

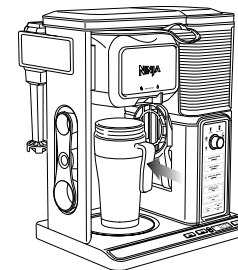

Half Carafe or Full Carafe

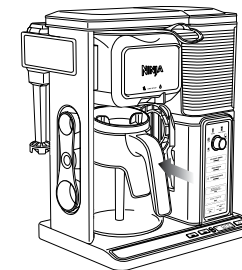

PLEASE KEEP THESE IMPORTANT SAFEGUARDS IN MIND WHEN USING THE APPLIANCE:

- ⚠ **CAUTION: APPLIANCE CREATES HOT LIQUID. HANDLE WITH CARE.**
- ⚠ **CAUTION: DO NOT** remove the vessel while the appliance is running without the Drip Stop in the closed position. Return the vessel quickly and open the Drip Stop to continue the brew.
- ⚠ **CAUTION: Never** open the brew basket when the coffeemaker is in use.
- ⚠ **CAUTION:** Please ensure that you are using at least a 12 oz. cup for the cup size, 14 oz. cup for the tall cup size, 16 oz. travel mug for the travel mug size and 20 oz. travel mug for the XL Multi-Serve size to prevent overflow and a scalding injury.

IMPORTANT: DO NOT run the appliance without water.

IMPORTANT: Always place a vessel beneath the brew basket to receive the brewed coffee.

IMPORTANT: DO NOT overfill the water reservoir. Fill water only to the Max Fill line.

- 1 Remove all packaging material, stickers and labels from the brewer.
 - NOTE:** The glass carafe is dishwasher safe. Place on top rack only.
- 2 Wash the water reservoir, permanent filter, glass carafe and brew basket in warm, soapy water with a soft cloth.
- 3 Rinse and dry thoroughly.
- 4 Wipe the intelligent warming plate with a damp cloth.
- 5 Before first use, prime the system by running two full carafe cycles with water only. After each cycle is complete, discard the brew.

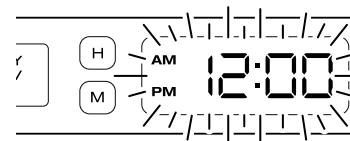

Fig. 1

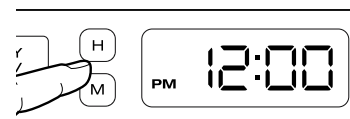

Fig. 2

TO SET THE CLOCK

- 1 Plug the power cord into an electrical outlet. The clock will flash on the control panel to indicate that the time has not been set. (Fig. 1)
- 2 Press the H (hour) or M (minute) button until you reach the current time. The AM or PM indicator will illuminate on the left side of the display as you are setting the time. (Fig. 2)
- 3 After 5 seconds the clock will stop flashing and the clock will be set.

NOTE: If the clock stops flashing and does not display the correct time of day, pressing the H (hour) or the M (minute) button at any time will cause the clock to flash again. You can now re-program the correct time of day by following the steps above.

NOTE: If you unplug the brewer or in the event of an extended power loss, you will need to reset the clock the next time the brewer is plugged in.

TO SET THE DELAY BREW TIME

NOTE: The Ninja Coffee Bar® must remain on in order for the delay brew function to work. Do not power off after setting Delay Brew.

- 1 Press Delay Brew. The Delay Brew button will illuminate and the clock will begin to flash "12:00" or the last delay brew time that was set. (Fig. 3)
- 2 While the clock is flashing, press the H (hour) or M (minute) button to set the time that you would like the delay brew to begin. The AM or PM indicator will illuminate on the left side of the display as you are setting the desired time.

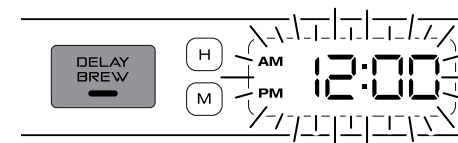

Fig. 3

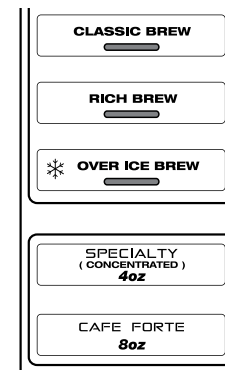

Fig. 4

- 3 Once the proper time has been set, select the size of the vessel that you would like to brew.
- 4 Select the Brew Type that you desire from the 5 flashing buttons. The selected brew type will be lit. (Fig. 4)
- 5 Once the time, brew size, and brew type have been set, allow the Delay Brew to flash and lock in or press the Delay Brew button to activate the Delay Brew. When the Delay Brew is activated, the light on the Delay Brew button will illuminate and an audible signal will play to verify the Delay Brew is set.
- 6 The Delay Brew time is now set and your Ninja Coffee Bar® will automatically brew at the time you programmed.
 - NOTE:** To deactivate the Delay Brew cycle, press the Delay Brew button once more and the light on the Delay Brew button will turn off. Any change to the selected brew size or starting any other brew will cancel the programmed Delay Brew.
- 7 Place the appropriate-sized vessel under brew basket for the selected size.

IMPORTANT: Make sure the Drip Stop is in the open position.

Go to ninjacoffeebar.com for more information and how-to videos.

Assembly

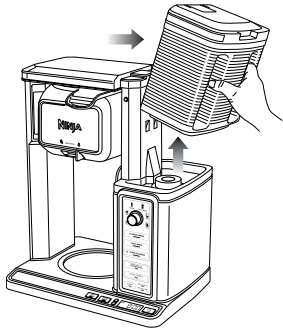

Fig. 5

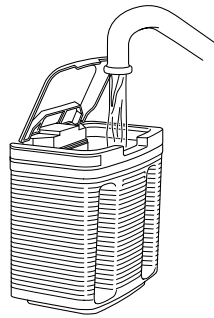

Fig. 6

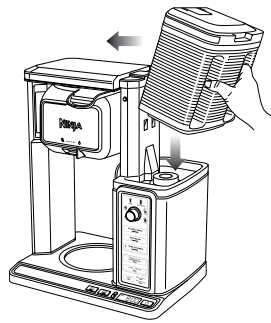

Fig. 7

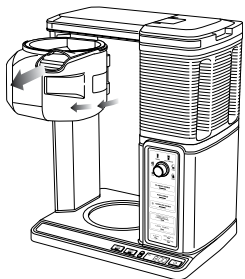

Fig. 8

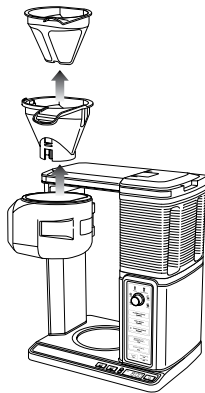

Fig. 9

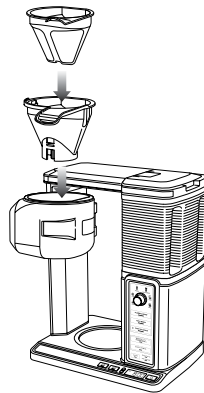

Fig. 10

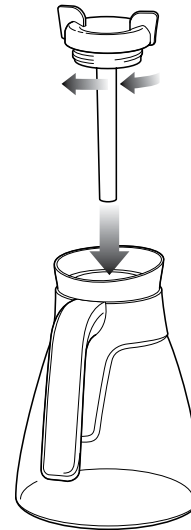

Fig. 11

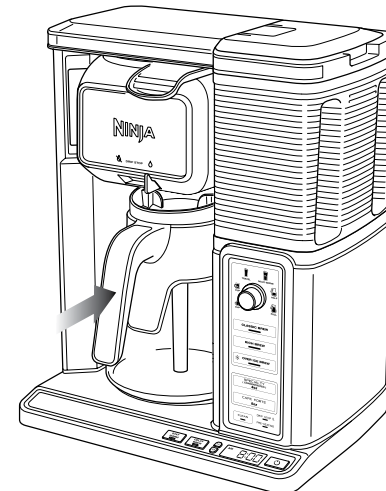

Fig. 12

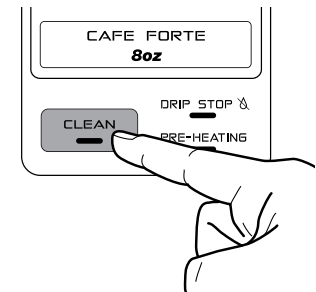

Fig. 13

- 1 Place the brewer on a dry, clean and level surface.
- 2 To easily fill the water reservoir, use the hand grips to lift the reservoir to the right and up off the brewer. **(Fig. 5)** The water reservoir lid flips open for easy filling, and the entire lid is easily removable for quick cleaning. Add fresh, filtered water at or above the minimum fill line for your desired beverage size **(Fig. 6)**, then return the water reservoir to the brewer by angling the reservoir into the holder and pushing in towards the brewer to lock into place. **(Fig. 7)** Do not fill water reservoir with any other liquids such as brewed coffee, carbonated beverages, etc. as other liquids may damage your brewer.

- 3 Slide brew basket out **(Fig. 8)** and lift both the permanent filter and Filter Carrier Insert from the brew basket to remove. **(Fig. 9)** To reinsert, set the permanent filter and Filter Carrier Insert back into the brew basket. **(Fig. 10)** When cleaning, you can remove the permanent filter from the brew basket.
- 4 Once the filter is in place, slide the brew basket all the way in until you hear a slight click.

- 5 Twist the brew-through lid clockwise onto the glass carafe to lock into place. **(Fig. 11)**
- 6 Center the carafe below the brew basket. **(Fig. 12)**
NOTE: Do not use any coffee for the first two brew cycles in order to clean the brewer.
- 7 Plug the brewer into an electrical outlet.

- 8 Once all parts are securely in place, press the Power Save button then press the CLEAN button to thoroughly clean the machine before first use. **(Fig. 13)**
- 9 Discard the water in the carafe and repeat, beginning with step 2, with one more Clean Cycle of water before first use.

Preparing and Using the Ninja Coffee Bar®

HOW MUCH COFFEE DO YOU GET IN YOUR CUP?

CAUTION: Please ensure that you are using at least a 12 oz. cup for the cup size, 14 oz. cup for the XL Cup size, 16 oz. travel mug for the travel mug size and 20 oz. travel mug for the XL Multi-Serve size to prevent overflow and a scalding injury.

Each size and brew type produces a different amount of coffee to optimize strength, taste, and size.

NOTE: The coffee grounds will absorb some of the water that is brewed, resulting in slightly less brewed coffee than water used.





APPROXIMATE BREW VOLUME

Size/Brew	Classic	Rich	Over Ice (coffee only)	Over Ice (filled with ice)
Cup	9.5 oz.	8.7 oz.	3.8 oz.	9.5 oz.
XL Cup	11.5 oz.	10.3 oz.	4.6 oz.	11.5 oz.
Travel Mug	14 oz.	13.2 oz.	5.9 oz.	14 oz.
XL Multi-Serve	18 oz.	16 oz.	7.3 oz.	18 oz.

Our Specialty Brew is always 4 oz. and Cafe Forte is always 8 oz., so you don't need to adjust the dial for our Signature Brews.

WOULD YOU LIKE A HOTTER COFFEE?

Have you ever wondered why coffee is served in paper cups when you order it to go? The type of cup you brew into can drastically influence the drinking temperature.

Cup Temperature	CERAMIC CUP			NINJA® CUP	PAPER CUP
	Room Temperature	Pre-warmed with hot water	Pre-warmed in microwave with milk		
Drinking Temperature	Hot 	Hotter 	Hotter 	Hotter 	Hottest 
Why is there a difference?	A cold ceramic mug will steal heat from the coffee as it warms itself up.	If the mug is already warm, it will not steal as much heat from the coffee.	Just like your cold mug, cold milk lowers the temperature of your coffee.	The Ninja double wall cup is designed to retain initial coffee temp better than a ceramic cup.	Unlike a ceramic mug, a thinner paper cup does not steal substantial heat from the coffee.

PRE-HEATING

- After plugging in or turning your brewer on from Power Save mode, press the Power Save button to initiate Pre-heating. You will see your pre-heat LED turn on.
- Allow 3 minutes for your brewer to pre-heat.
- After 3 minutes, the light will turn off. Your brewer has now pre-heated.
- Your Ninja Coffee Bar will in stay pre-warmed mode unless you put the brewer into power save mode by pressing the Power Save Button.

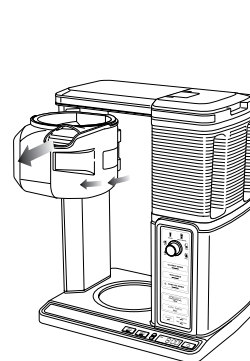

Fig. 14

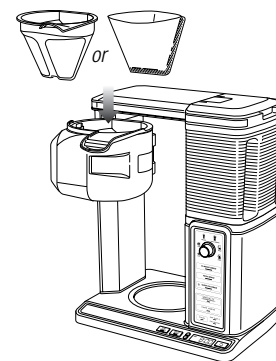

Fig. 15

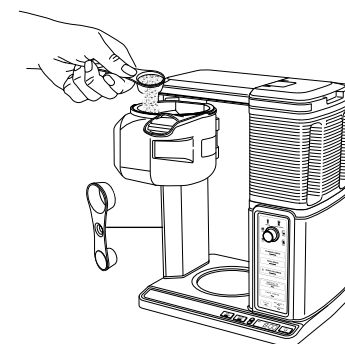

Fig. 16

FILLING THE BREW BASKET WITH COFFEE

For best results, use the below measurements of ground coffee for each size brew—the amount of ground coffee for each size will remain the same for any brew type that you select. For example, if you select Cup and Classic Brew, you will use the same amount of coffee grounds as if you select Cup and Over Ice Brew.

CAUTION: The maximum capacity for ground coffee is 12 rounded tablespoons or 6 Ninja Big Scoops. Exceeding this amount or using fine ground coffee may cause overflow.

- Open the brew basket by sliding it out of the brewer. (Fig. 14)

NOTE: Check for any loose grounds that may be left in the brew basket. Remove and rinse the brew basket if needed.

- Place the permanent filter or a #4 paper cone filter in the brew basket. If using a paper filter, first ensure the permanent filter is removed from the brew basket. Then fold a #4 paper cone filter along the seams and insert firmly into the brew basket. (Fig. 15)

- Use the Ninja Scoop and follow the measurements in the chart to fill the filter. These measurements are based on level scoops—adjust to your preferred taste. (Fig. 16) We suggest using a medium grind size if grinding whole beans.

Serving Size	Ninja® Scoop	Tablespoons
Cup / XL Cup	2–3 small scoops	2–3 Tbsp.
Travel Mug / XL Multi-Serve	3–5 small scoops	3–5 Tbsp.
Half Carafe	3–4 big scoops	6–8 Tbsp.
Full Carafe	4–6 big scoops	8–12 Tbsp.
Signature Brews	Ninja® Scoop	Tablespoons
Specialty (4oz. Brew)	2 big scoops	4 Tbsp.
Cafe Forte (8oz. Brew)	2 big scoops	4 Tbsp.

NOTE: Exceeding the recommended medium grind size for whole beans may cause the brew basket to overflow.

- Slide the brew basket back into the brewer and click in place.

Preparing and Using the Ninja Coffee Bar® - cont.

- ⚠ **CAUTION: HOT WATER** Do not remove the brew basket or vessel while brewing.
- ⚠ **CAUTION: STEAM** Do not touch steam vents or the top of the brewer while brewing.
- ⚠ **CAUTION:** The brew basket is hot after brewing. Always allow the brewer to cool down before cleaning.

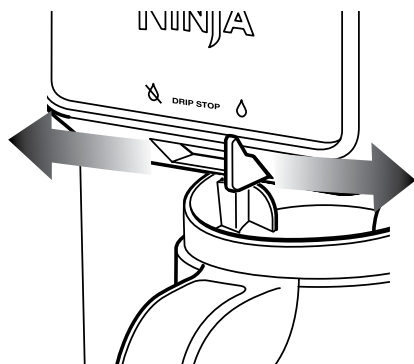

Fig. 17

DRIp STOP

NOTE: If the Drip Stop is closed before you begin a brew, the brewer will notify you with 5 beeps and the Drip Stop light will be illuminated. Set the Drip Stop to the open position and select your brew concentration level.

CAN'T WAIT FOR THAT FIRST CUP TO BE READY?

When brewing a carafe, close the Drip Stop to pause the brew cycle and pour a cup. Remember to reopen the Drip Stop to complete the brew. (Fig. 17)

NOTE: If you forget to open the Drip Stop, the Ninja Coffee Bar will pause the brew, and after 20 seconds it will give you a friendly audible reminder. After 6 minutes the brew will be canceled.

CAN'T WAIT FOR THE LAST FEW DROPS?

When the brew cycle is complete, set the Drip Stop to the closed position to stop dripping from the brew basket.

NOTE: While the Drip Stop is closed the Drip Stop indicator will light up in the bottom right hand corner of the control panel.

NOTE: Remember to open the Drip Stop when you're ready to brew again. If you forget, your Ninja Coffee Bar will give you a friendly audible reminder.

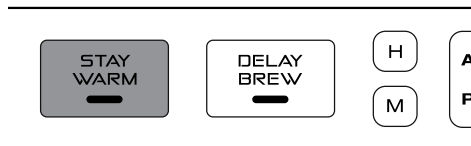

Fig. 18

INTELLIGENT WARMING PLATE

The Intelligent Warming Plate will automatically turn on after a full or half carafe size of Classic or Rich brew. The Intelligent Warming Plate will adjust the heat it produces in order to avoid burning the coffee over time.

⚠ **CAUTION:** The **HOT SURFACE** light will illuminate when the warming plate is hot. Do not touch the surface when this light is illuminated.

STAY WARM BUTTON

Press the Stay Warm Button after the brew to turn the Intelligent Warming Plate off. You can turn the Intelligent Warming Plate back on within 2 hours of the brew by pressing the stay warm button again if desired. (Fig.18)

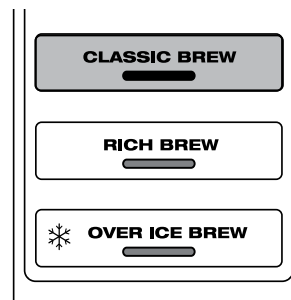

Fig. 19

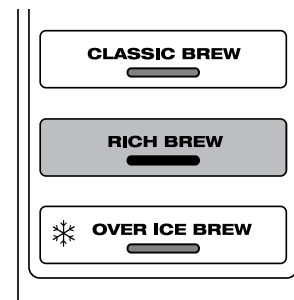

Fig. 20

BREWING COFFEE

NOTE: Each brew has a pre-infusion cycle with varying times. The brew will begin, stop, and be quiet for a short period of time before it begins again. This process is used to evenly saturate your coffee grounds.

NOTE: For a hotter coffee, rinse the coffee cup, mug or glass carafe with hot water prior to brewing.

⚠ **CAUTION:** Ensure the coffee cup, mug or glass carafe is completely empty before starting a brewing cycle. Starting a brewing cycle with coffee in the vessel will cause an overflow.

CUSTOM BREWS: CLASSIC, RICH OR OVER ICE BREW

Classic Brew - For a smooth, balanced flavor.

Rich Brew - For a coffee that is richer than Classic Brew and still smooth, with more room for milk and cream.

- 1 After filling the water reservoir and adding ground coffee to the filter, be sure that the Drip Stop is open and the reservoir, basket, and filter are securely in place.
- 2 Use the Multi-Serve dial to select the size of coffee you would like to brew. Place the empty vessel that you would like to brew into underneath the brew basket.

NOTE: If making a single cup, lower the Multi-Serve Cup Platform down and center the cup or mug on the cup platform. Please ensure that you are using at least a 12 oz. cup for the cup size, 14 oz. cup for the tall cup size, 16 oz. travel mug for the travel mug size and 20 oz. travel mug for the XL Multi-Serve size.

- 3 Press the CLASSIC BREW or RICH BREW button and the brew will begin. (Fig. 19, Fig. 20) Press the CLASSIC BREW or RICH BREW button again to cancel the brew.

NOTE: The brew will begin, stop, and be quiet for a short period of time before it begins again. This process is used to evenly saturate your coffee grounds.

NOTE: If brewing a half carafe or a full carafe, the Stay Warm indicator and Intelligent Warming Plate will automatically turn on. (Fig. 19, Fig. 20) This can be turned off by pressing the Stay Warm button once illuminated. The Intelligent Warming Plate will turn off automatically after 2 hours.

NOTE: Do not remove water reservoir, brew basket, or vessel while brewing.

- 4 The Ninja Coffee Bar® will beep to signal a completed brew.

NOTE: Rich Brew will use slightly less water and yield slightly less brewed coffee than Classic Brew.

Preparing and Using the Ninja Coffee Bar® - cont.

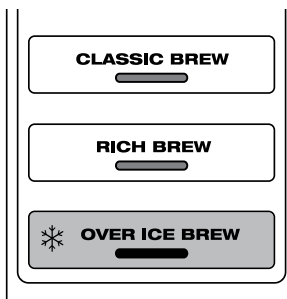

Fig. 21



Fig. 22



Fig. 23

OVER ICE BREW

Designed to brew hot coffee over ice to lock in the flavor for a rich, freshly brewed, smooth iced coffee without becoming watered down. Be sure your vessel is filled with ice before brewing.

CAUTION: DO NOT USE GLASSWARE. However, the provided glass carafe is safe to use due to the specialized glass material.

- 1 After filling the water reservoir, add ground coffee to the filter (feel free to add more coffee if you like a stronger taste.) Be sure that the Drip Stop is open and the reservoir, basket and filter are in place.
- 2 Use the Multi-Serve dial to select the size of coffee that you would like to brew.
- 3 Before brewing, fill the desired vessel to the top with ice cubes and place the vessel below the brew basket. Press the OVER ICE BREW button and the brew will begin. (Fig. 21) Press the OVER ICE BREW button again to cancel the brew.

IMPORTANT: Always fill the desired vessel to the top with ice before placing it below the brew basket. Do not add ice to the water reservoir.

NOTE: The brew will begin, stop, and be quiet for a short period of time before it begins again. This process is used to evenly saturate your coffee grounds.

NOTE: If making a carafe of Over Ice Brew, fill the carafe with ice and brew without the brew-through lid.

- 4 The Ninja Coffee Bar will beep to signal a completed brew. Stir to cool coffee completely.

CAUTION: Make sure to use the proper cup size, to prevent coffee overflowing the cup.

Go to ninjacoffeebar.com for more information and how-to videos.

NINJA BREWS

Specialty and Cafe Forte brews deliver a specific amount of concentrated coffee for the perfect brew every time. Specialty delivers approximately 4 oz. and Cafe Forte delivers approximately 8 oz.

SPECIALTY OR CAFE FORTE BREW

The Specialty Brew produces a strong coffee concentrate perfect for an iced blended coffee drink or milk-based specialty drink.

Cafe Forte has a deep, full-bodied, and complex flavor that is rich and drinkable. It tastes great black—no milk or sweeteners needed. Refer to the Inspiration Guide for recipes.

- 1 After filling the water reservoir and adding ground coffee to the filter, be sure that the Drip Stop is open and that the reservoir, basket and filter are securely in place.

Note: If brewing an iced blended drink, fill the desired vessel with the amount of ice recommended in the recipe before brewing.

- 2 Place the vessel that you would like to brew into underneath the brew basket. Press the SPECIALTY BREW button or CAFE FORTE button and the brew will begin. (Fig. 22, 23) Press the SPECIALTY BREW button or CAFE FORTE button again or press the Power Save button to cancel the brew.

NOTE: The brew will begin, stop, and be quiet for a short period of time before it begins again. This process is used to evenly saturate your coffee grounds.

NOTE: No matter which size is selected on the Multi-Serve dial, Specialty will always brew 4 oz. and Cafe Forte will always brew 8 oz.

- 3 The Ninja Coffee Bar will beep to signal a completed brew.

CAUTION: DO NOT reach across the top of the brewer to froth during brewing. Steam is released from vent on top of brewer and can result in a steam burn.

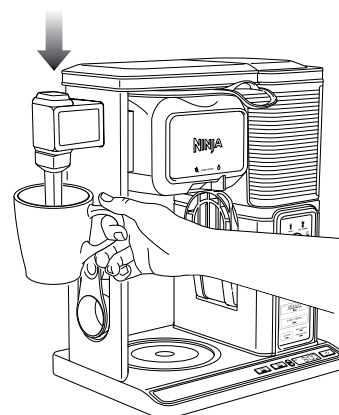

Fig. 24

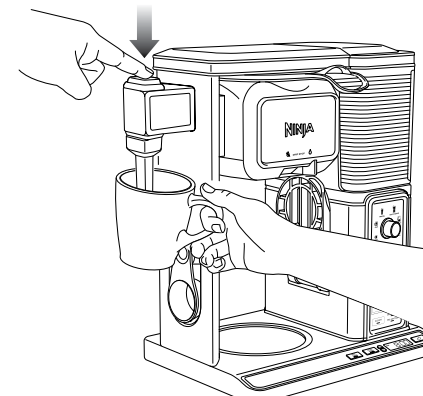

Fig. 25

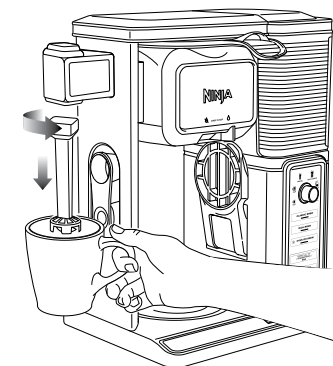

Fig. 26

FROTHING YOUR MILK

- 1 Pour milk into cup, until it is about one-third full. (Use more or less milk depending on your preference.) Microwave for 45-60 seconds for hot milk.
- 2 Move the frother into the ready position by swinging the arm toward the front.
- 3 Hold cup under the frother and submerge the whisk just below the surface of the milk. This allows air to fold into the milk, for the frothiest results. (Fig. 24)
- 4 Press and hold the frothing button for 30 to 45 seconds. (Fig. 25)
- 5 You can easily remove the frother whisk by twisting it clockwise. Keep your cup below the whisk and carry it to your sink or dishwasher for cleaning. (Fig. 26)

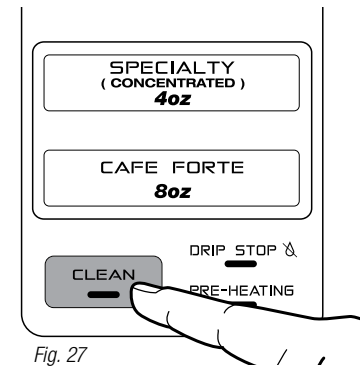

Fig. 27

CLEANING AFTER A BREW

- ⚠ **CAUTION:** Make sure that the brewer is unplugged from the power source before cleaning.
- ⚠ **CAUTION:** Be sure to allow the brewer to cool before cleaning.
- IMPORTANT:** Discontinue use if the glass carafe is scratched or handle is loose or damaged.
- NOTE:** Do not leave coffee in the glass carafe for an extended period of time after a brew.

NOTE: Do not leave water in or underneath the water reservoir unused for multiple days. Rinse and replace with fresh water.

- 1 Before cleaning, close the Drip Stop.
- 2 After each brew is complete and the coffee grounds have cooled, carefully remove the permanent filter and wash. If using a paper filter, simply discard. Remove brew basket from the brewer, rinse and wash with soap and warm water.
- 3 After each froth, rinse thoroughly or place the frother whisk on top rack of dishwasher.
 - NOTE:** The swinging brew basket is not dishwasher safe.
 - NOTE:** The flip-top reservoir lid is not dishwasher safe.
 - NOTE:** If coffee grounds spilled over into the brew basket or in the overflow channels, remove and rinse under water until grounds are removed.

- 4 Wash the carafe and brew-through lid with soap and warm water. Use a bottle brush or a cloth to wash the inside of the carafe.
 - NOTE:** The brew-through lid, glass carafe, permanent filter and water reservoir are top shelf dishwasher safe.
 - IMPORTANT:** Clean the glass carafe with a soft brush or sponge. Do not use a wire brush.

- 5 Wipe machine down with a warm cloth with soap and water. Let the warming plate cool before cleaning with a wet cloth and soap and water. Clean shower head, the water reservoir shelf, the water reservoir, flip-top water reservoir lid, the removable filter carrier and Filter Carrier Insert with soap and water. **Do not immerse the base in water.**

NOTE: For best results, use a bottle brush. This will allow you to scrub all of the inside with soap and hot water.

CLEANING YOUR CARAFE

We recommend rinsing your carafe with warm soapy water, or placing in the top shelf of your dishwasher.

If you want to clean the carafe more thoroughly, we recommend using a soft foam brush such as the one shown.



CLEANING YOUR WATER RESERVOIR

- 1 Empty the water reservoir.
- 2 Hand wash with dish soap and rinse, or place on the top rack of your dishwasher.
- 3 Clean the water reservoir shelf with cloth and warm soapy water.

HOW TO CLEAN & DESCALE THE BREWING SYSTEM

- ⚠ **CAUTION:** Be sure to allow the brewer to cool before cleaning.
- ⚠ **CAUTION:** DO NOT immerse the coffeemaker into water or any other liquid.

The CLEAN button will illuminate when there is a calcium buildup on your Ninja® Coffee Bar that could be affecting the flavor of your coffee. If you do not clean your brewer when instructed to do so, eventually the CLEAN light will flash and an urgent “Clean” message will appear on the clock display. The cleaning cycle is a two stage process, the reservoir is first filled with cleaning solution and later with clean water to flush the system.

To clean and descale your Ninja Coffee Bar:

- 1 Select the Carafe size and set the carafe beneath the brew basket.
 - 2 Use a descaling solution and follow the directions on the package. Fill the water reservoir up to but not exceeding the Max Fill line (43 oz.)
- OR**
- 3 Fill the water reservoir to the Travel Mug line (16 oz.) with white vinegar, then fill the rest of the reservoir with water up to but not exceeding the Max Fill line (43 oz.)
 - IMPORTANT:** Use only white vinegar.
 - 4 Once the water reservoir is filled with your cleaning solution and water mixture, press the CLEAN button. **(Fig. 27)**

- 5 Your Ninja Coffee Bar will deliver a small amount of water to distribute the cleaning mixture through the system. It will then pause for one hour as the clock display counts down. Do not remove the carafe from the base during this period, as there will be additional water delivered.

- 6 After one hour, your Ninja® Coffee Bar will discharge the remainder of the cleaning mixture into the carafe. Upon completion, the Ninja Coffee Bar will beep, and a “Flush” message will appear on the clock screen.
- 7 Empty and thoroughly clean the carafe and water reservoir to remove any cleaning solution that could affect the flavor of your coffee.
- 8 Fill the reservoir with fresh water up to but not exceeding the Carafe line (43 oz. Max Fill line) and set the carafe beneath the brew basket.
- 9 Press the CLEAN button to begin the Flush stage. (The Flush stage takes approximately 8 minutes.)
- 10 Upon completion of the Flush stage, the CLEAN light will turn off. Discard the water in the carafe.
 - NOTE:** If the CLEAN light illuminates again, then calcium buildup is still present. Repeat the steps above and the CLEAN light will automatically shut off when your brewer is clean.
 - Please call Customer Service at 1-877-646-5288 to purchase descaling solution or if the brewer needs any servicing.



Troubleshooting Guide

PROBLEMS	POSSIBLE REASONS & SOLUTIONS
Sediment in my coffee.	If there is sediment at the bottom of the brewed coffee, this may be due to using finely ground coffee in the permanent filter. To reduce the amount of sediment in the brewed coffee use a slightly coarser grind or use a paper filter.
Grounds in my coffee.	If there are grounds in your coffee, check to make sure the brew basket did not overflow. If there are too many grounds in the brew basket, or you are using a fine ground coffee, the grounds will flow into an overflow channel designed to make sure overflow is captured in the brew vessel. For best results use medium ground coffee in the recommended measurements.
Brew Basket dripping after brew.	Check to see if the Drip Stop toggle is set to the closed, no-drip position. If the Drip Stop is set to the closed, no drip position and the brewer continues to drip, run a Clean Cycle or wash the brew basket thoroughly with warm, soapy water.
Paper filter falling over.	The Ninja Coffee Bar® is designed to take a #2 cone filter. Be sure you are using this size and shape for best results. Be sure the paper filter is firmly pressed into the brew basket. Wet the corners of the filter for best results. If problem persists, try using the permanent filter.
Coffee is not hot enough.	To keep your coffee hotter longer, pre-heat your mug or carafe by rinsing it with hot water from the tap. If using a microwave safe mug with cream or milk, try pre-heating the cream or milk in the microwave for 30 seconds. NOTE: Never place carafe in the microwave.
Over Ice Brew is not cold.	The Over Ice Brew is designed to brew hot coffee over ice to lock in the flavor for rich, smooth iced coffee. Make sure your cup, travel mug, or carafe is filled all the way to the top with ice cubes.
Weak coffee.	If the coffee tastes weak, try adding more coffee grounds into the brew basket for the next brew cycle. If the coffee is still weak after adding more coffee grounds, try Rich Brew to make a stronger, more concentrated cup.
Coffee too strong.	Try using a coarser grind. If the coffee is still too strong, try using less coffee grounds.
Brew will not start.	Make sure the Power Save Button light is illuminated. Check to make sure the brewer is plugged in and water is in the water reservoir. If the Drip Stop is in the open position, check that the brew basket is pushed all the way into the brewer. If you hear 5 beeps, check that the Drip Stop is in the open position. NOTE: The brew will begin, stop, and be quiet for a short period of time before it begins again. This process is used to evenly saturate your coffee grounds.
Brew cycle is too slow.	A carafe brew will take approximately 8 minutes and the single cup will take approximately 4 minutes. If the brew cycle is taking longer than normal, run the Clean Cycle with the descaling solution.

PROBLEMS	POSSIBLE REASONS & SOLUTIONS
My cup, travel mug or carafe overflowed.	The cup, travel mug or carafe may not have been empty prior to brewing. The water exceeded the Max Fill line on the water reservoir prior to brewing. The Ninja Coffee Bar® is designed to dispense the following amounts on Classic brew: Cup 9.5 oz. XL Cup 11.5 oz. Travel Mug 14 oz. XL Multi-Serve 18 oz. Half Carafe 28 oz. Carafe 43 oz. Please ensure that you are using at least a 12 oz. cup for the cup size, 14 oz. cup for the XL Cup size, 16 oz. travel mug for the travel mug size and 20 oz. travel mug for the XL Multi-Serve size. NOTE: On Rich Brew and Over Ice Brew there will be less volume dispensed. Specialty Brew will deliver approximately 4 oz. and Cafe Forte will deliver approximately 8 oz.
Brew basket overflowed.	Check the amount of coffee or type of grind used.
Water left in my reservoir.	Ninja Coffee Bar allows you to fill the reservoir up to but not exceeding the Max Fill line and Auto-iQ™ One-Touch Intelligence will only use the water needed for the brew size and style selected. After a brew you may notice leftover water in your water reservoir after filling to the minimum fill line of the size selected. The water reservoir markings are minimum fill lines that indicate if there is enough water for the proper brew size in the reservoir, but all brew styles use different amounts of water to create the proper flavor and concentration. You can brew multiple cups before needing to refill.
Does it take coffee pods?	This brewer is designed to brew coffee grounds only. Do not insert pods or K-Cups®.
My Ninja Coffee Bar is leaking.	If the leak is coming from the brew basket, be sure all the parts are fit securely in the brewer. If the leak is coming from the bottom of the brewer, call customer service at 1-877-646-5288.
My Ninja Coffee Bar beeped and did not complete the full brew that I selected.	Ensure the water reservoir is locked in place and is filled with enough water for the desired brew. Check the CLEAN indicator light. If illuminated, run a Clean Cycle with the appropriate descaling solution or a white vinegar mixture. See Care & Maintenance section. Check the Drip Stop indicator light. If illuminated, ensure the brew basket is fully inserted into the brewer and open the Drip Stop once the vessel is placed under the brew basket. If the problem persists, please call customer service at 1-877-646-5288.
Why is the second cup that I brewed hotter than the first cup?	Once the Ninja Coffee Bar has brewed the first cup, the brewing system is pre-warmed. This enables any following brews to be slightly hotter. For a hot first cup, try pre-warming your mug. Or after pugging in or turning on your brewer from Power Save mode, allow 3 minutes for your brewer to preheat.

*K-Cup is a registered trademark of Keurig Green Mountain, Inc. Use of the K-Cup trademark does not imply any affiliation with or endorsement by Keurig Green Mountain, Inc.

ONE (1) YEAR LIMITED WARRANTY

PROBLEMS	POSSIBLE REASONS & SOLUTIONS
I noticed the carafe design & lid. What are the benefits?	Our unique carafe shape and design has the following benefits: Easy-grip design makes it easy to pour coffee without dripping. Thoroughly mixes your coffee from the first drop to the last thanks to the brew-through carafe lid. Optimizes coffee temperature. Allows you to brew both hot and iced coffee.
Coffee Brew Volume: What impacts coffee brew volume?	When you make hot coffee, coffee grounds will absorb some of the water that is brewed, resulting in slightly less brewed coffee than the water used. The more coffee you use, the more water will be absorbed. Additionally, our wider bottom carafe holds most of the volume coffee at the base which helps control the temperature more evenly. Classic Brew:   Full Carafe Half Carafe
How does the Ninja Coffee Bar® keep coffee at the right temperature?	The carafe is designed to keep most of the coffee volume in the bottom so it can be held closer to the Intelligent Warming Plate. This helps maintain the coffee at the ideal drinking temperature.

Go to ninjacoffeebar.com for more information and how-to videos.

SharkNinja Operating LLC warrants this product to be free from material defects and workmanship for a period of one (1) year from the date of purchase when utilized for normal household use, subject to the following conditions, exclusions and exceptions.

The liability of **SharkNinja Operating LLC** is limited solely to the cost of the repair or replacement of the unit at our option. This Limited Warranty does not cover normal wear of parts and does not apply to any unit that has been tampered with or used for commercial purposes. This Limited Warranty does not cover damage caused by misuse, abuse, negligent handling or damage due to faulty packaging or mishandling in transit. This Limited Warranty does not cover damage or defects caused by or resulting from damages from shipping or from repairs, service or alteration to the product or any of its parts, which have been performed by a repair person not authorized by **SharkNinja Operating LLC**.

If your appliance fails to operate properly while in use under normal household conditions within the warranty period, return the complete appliance and accessories, freight prepaid. For assistance with warranty service options or customer support, please call our customer care and product specialists at 1 (877) 646-5288 or visit our website ninjacoffeebar.com.

If the appliance is found to be defective in material or workmanship, **SharkNinja Operating LLC** will repair or replace it free of charge. Proof of purchase is required and a fee of \$19.95 will apply to cover the cost of return freight.*

This Limited Warranty is extended to the original purchaser of the unit and excludes all other legal, implied and/or conventional warranties. The responsibility of **SharkNinja Operating LLC**, if any, is limited to the specific obligations expressly assumed by it under the terms of this Limited Warranty. In no event is **SharkNinja Operating LLC** liable for incidental or consequential damages to anyone of any nature whatsoever. Some states do not permit the exclusion or limitation of incidental or consequential damages, so the above may not apply to you.

This Limited Warranty gives you specific legal rights, and you may also have other rights which vary from state to state or from province to province.

***IMPORTANT: Carefully pack item to avoid damage in shipping. Be sure to include proof of purchase date and to attach tag to item before packing with your name, complete address and phone number with a note giving purchase information, model number and what you believe is the problem with the item. We recommend you insure the package (as damage in shipping is not covered by your Limited Warranty). Mark the outside of your package "ATTENTION CUSTOMER SERVICE".**

Product Registration

Please visit ninjacoffeebar.com or call 1-877-646-5288 to register your new Ninja® product within ten (10) days of purchase. You will be asked to provide the store name, date of purchase and model number along with your name and address.

The registration will enable us to contact you in the unlikely event of a product safety notification. By registering, you acknowledge to have read and understood the instructions for use and warnings set forth in the accompanying instructions.

Replacement Parts

ORDERING REPLACEMENT PARTS

To order additional parts and attachments, please visit ninjacoffeebar.com or feel free to contact customer service: **1-877-646-5288**.



SharkNinja Operating LLC

US: Newton, MA 02459

CAN: Ville St-Laurent, QC H4S 1A7

1-877-646-5288

ninjacoffeebar.com

Copyright © 2016 SharkNinja Operating LLC

For SharkNinja U.S. Patent information visit sharkninja.com/USPatents

Ninja, Ninja Coffee Bar and Thermal Flavor Extraction are registered trademarks of SharkNinja Operating LLC.

Auto-iQ is a trademark of SharkNinja Operating LLC.

Printed in China

Illustrations may differ from actual product. We are constantly striving to improve our products, therefore the specifications contained herein are subject to change without notice.

CF091_Series_32_IB_160831_1