

# eLIGHT

# eLIGHT

*Semi Flush Mount Light*

*Model 6103*

## INSTALLATION MANUAL

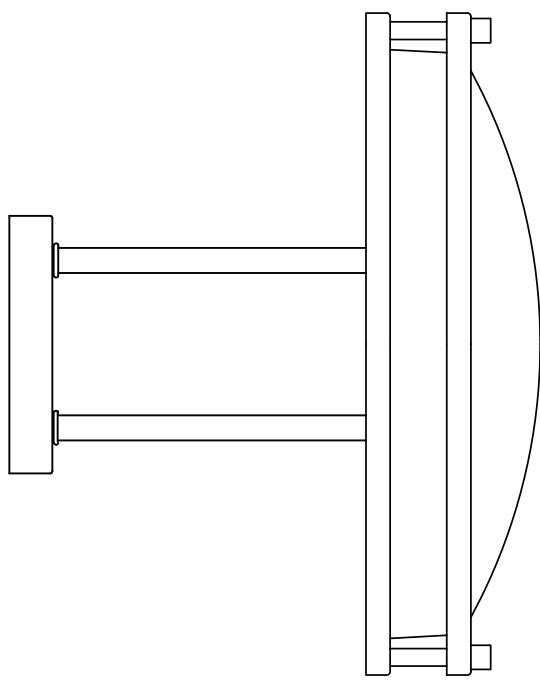



Thank you for purchasing this eLIGHT Ceiling Semi Flush Mount Light Fixture. This product has been manufactured with the highest standards of safety and quality.

**FEATURES:**





1. Easy to install.
2. Metal frame and frosted glass.
3. For energy savings this fixture has been engineered to safely use a Self Ballasted Compact Fluorescent Lamp in place of an incandescent lamp.

**CAUTION:**

-  **DANGER:** Before installation, turn off the main power at the circuit breaker.
-  **WARNING:** Installation must be performed by a qualified licensed electrician.
-  **CAUTION:** To prevent electric shock, do not insert any objects through openings or attempt to open the adapter.

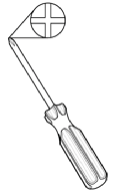
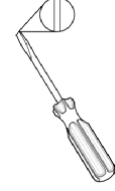
**TOOLS REQUIRED FOR INSTALLATION AND ASSEMBLY**

(not included):

-  Phillips Screwdriver
-  Flathead Screwdriver
-  Wire Cutters
-  Wire Strippers
-  Safety Goggles
-  Electrical Tape

**PRODUCT MAINTENANCE:**

1. To clean the outside of the fixture, use a dry or slightly dampened clean cloth (use clean water, never a solvent) to wipe the surface of the fixture.
2. To clean the inside of the fixture, first disconnect power to the fixture by turning off the circuit breaker or by removing the fuse at the fuse box. Next, use a dry or slightly dampened clean cloth (use clean water, never a solvent) to wipe the interior surface of the fixture.
3. Do not use any cleaners with chemicals, solvents or harsh abrasives. Use only a dry soft cloth to dust and wipe carefully.

**LIMITED WARRANTY**

The manufacturer warrants this lighting fixture to be free from defects in materials and workmanship for a period of two (2) years from date of purchase. This warranty applies only to the original consumer purchaser and only to products used in normal use and service. If this product is found to be defective, the manufacturer's only obligation, and your exclusive remedy, is the repair or replacement of the product at the manufacturer's discretion, provided that the product has not been damaged through misuse, abuse, accident, modifications, alterations, neglect or mishandling. This warranty shall not apply to any product that is found to have been improperly installed, set-up, or used in any way not in accordance with the instructions supplied with the product. This warranty shall not apply to a failure of the product as a result of an accident, misuse, abuse, negligence, alteration, or faulty installation, or any other failure not relating to faulty material or workmanship. This warranty shall not apply to the finish on any portion of the product, such as surface and/or weathering, as this is considered normal wear and tear. The manufacturer does not warrant and specially disclaims any warranty, whether expressed or implied, of fitness for a particular purpose, other than the warranty contained herein. The manufacturer specifically disclaims any liability and shall not be liable for any consequential or incidental loss or damage, including but not limited to any labor/expense costs involved in the replacement or repair of said product.

**KEEP your receipt and these Instructions for Proof of Purchase.**

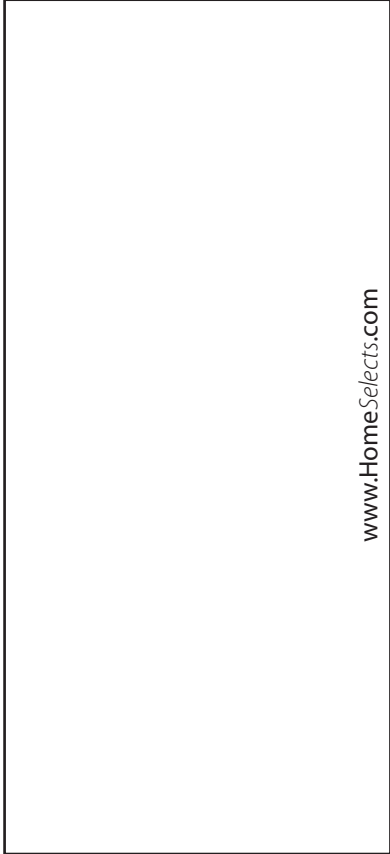

[www.HomeSelects.com](http://www.HomeSelects.com)

# ASSEMBLY

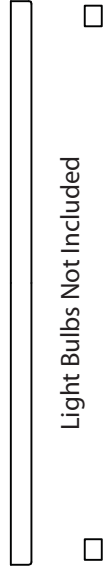
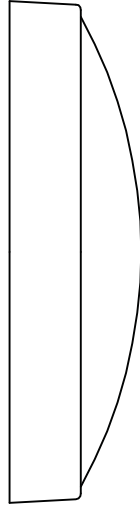
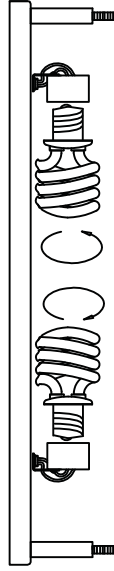
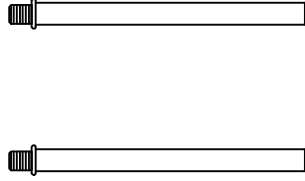
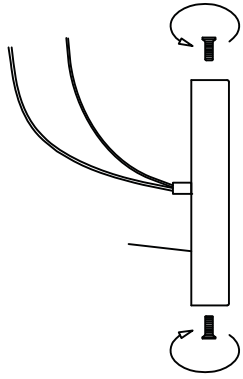

Light Bulbs Not Included



## TROUBLESHOOTING:

Possible Cause	Corrective Action
Light will not turn on.	<ol style="list-style-type: none"> <li>1. Power is off.</li> <li>2. Faulty switch.</li> <li>3. Faulty wire connection.</li> </ol>
Fuse blows or circuit breaker trips when light is turned on.	<ol style="list-style-type: none"> <li>1. Crossed wires or power wire is grounding out.</li> </ol>

# PARTS INCLUDED FOR INSTALLATION

(parts are not to scale):

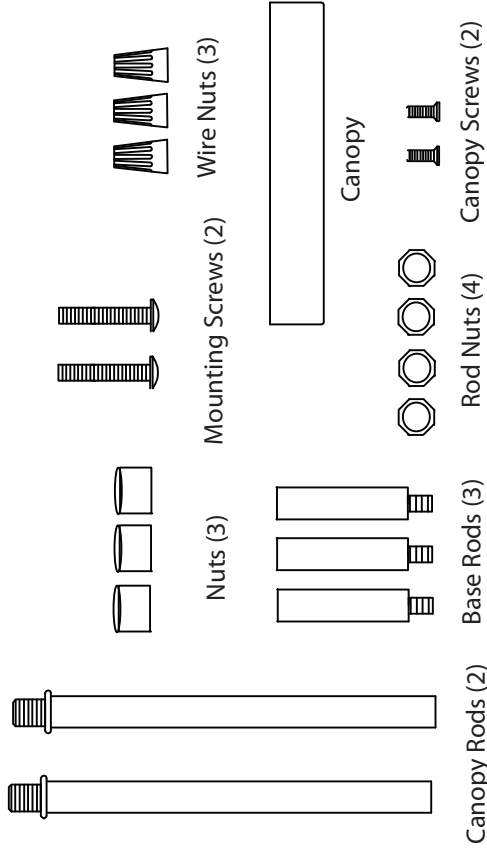

Canopy Rods (2)

Base Rods (3)

Rod Nuts (4)

Canopy Screws (2)

Mounting Screws (2)

Wire Nuts (3)

Nuts (3)

Canopy

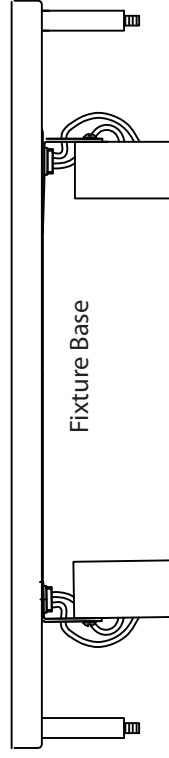

Fixture Base

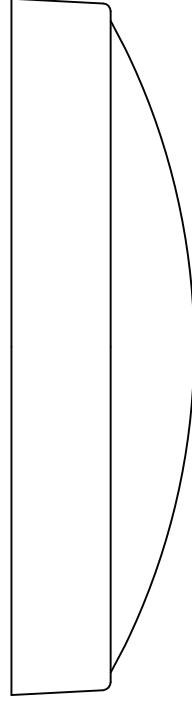

Glass Globe



Decorative Ring

## INSTALLATION:

### INSTALLATION INSTRUCTIONS:

#### CAUTION:

**!** **DANGER:** Before installation, turn off the main power at the circuit breaker.

1. Insert the metal canopy rods into the canopy and secure with nuts.
2. Insert the metal canopy rods into the fixture housing and secure with nuts.
3. Thread the fixture wires through one of the metal rods.
4. Install the canopy mounting bracket to the ceiling box with supplied screws.
5. Make the wiring connections using the supplied wire nuts from the light fixture to the supply wires in the ceiling box.
6. Slide the canopy housing over the mounting bracket and secure with the canopy screws.
7. Install light bulbs (not included)
8. Install the glass globe using the decorative ring and decorative nuts.

NOTE: If you have electrical questions, consult your local electrical code for approved grounding methods.

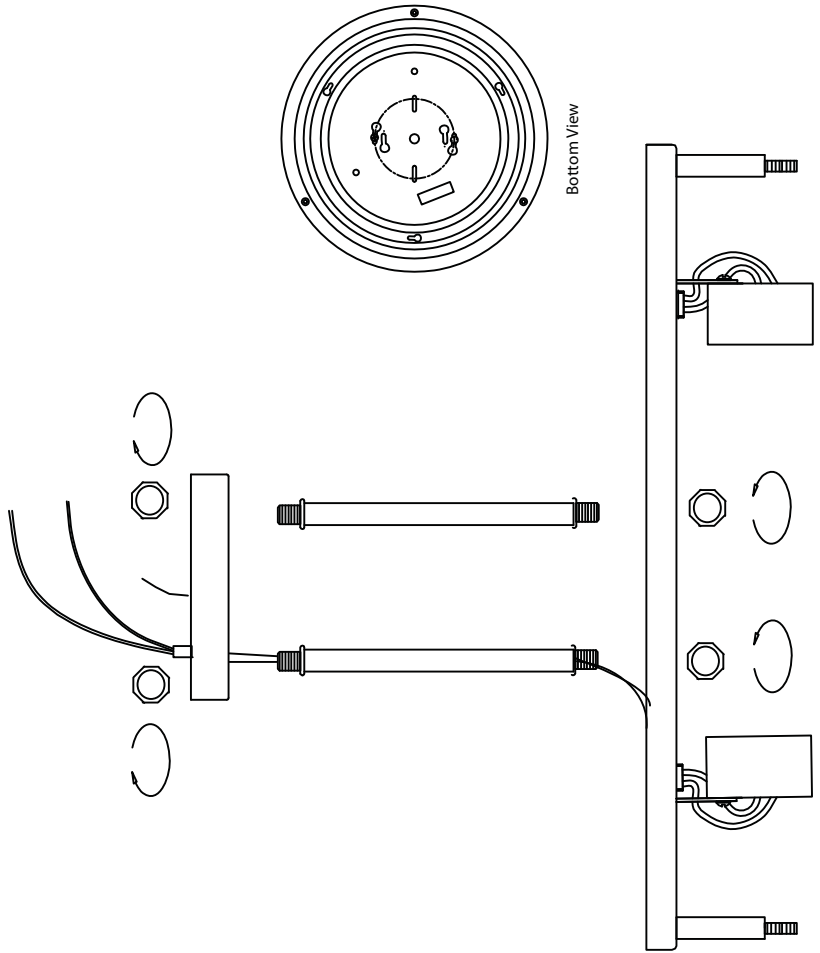

### INSTALLATION INSTRUCTIONS: (Continued)

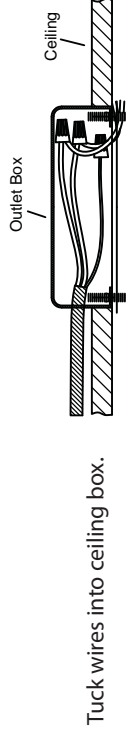

Tuck wires into ceiling box.

