



*Thinking of you*  
**Electrolux**



.....  
Dual Fuel Slide-In Range

.....  
Use and Care Guide

## CONTENTS

- |  |   |
|--|---|
| <ul style="list-style-type: none"> <li><b>8</b> Before Setting Surface Controls</li> <li><b>9</b> Burner Cap Placement</li> <li><b>10</b> Installing Burner Grates</li> <li><b>11</b> Setting Surface Controls           <ul style="list-style-type: none"> <li><b>11</b> Setting Proper Burner Flame Size</li> <li><b>12</b> Setting Surface Controls</li> <li><b>13</b> Home Canning</li> </ul> </li> <li><b>14</b> Before Setting Oven Controls           <ul style="list-style-type: none"> <li><b>15</b> Luxury Glide™ Oven Racks</li> </ul> </li> <li><b>16</b> Setting Oven Controls           <ul style="list-style-type: none"> <li><b>18</b> Setting the User Preferences</li> <li><b>22</b> Rapid Preheat</li> <li><b>23</b> Bake</li> <li><b>25</b> Broil</li> </ul> </li> </ul> | <ul style="list-style-type: none"> <li><b>26</b> Convection Bake</li> <li><b>32</b> Meat Probe</li> <li><b>37</b> Setting Multi Stage</li> <li><b>40</b> The Lower Oven</li> <li><b>41</b> My Favorite</li> <li><b>43</b> The Sabbath Mode</li> <li><b>45</b> Self Clean</li> <li><b>48</b> Care and Cleaning           <ul style="list-style-type: none"> <li><b>50</b> Cleaning Surface Burner Heads</li> <li><b>51</b> Caring for Your Glide Racks</li> <li><b>52</b> Removing and Replacing the Oven Door</li> </ul> </li> <li><b>54</b> Before You Call           <ul style="list-style-type: none"> <li><b>54</b> Solutions to Common Problems</li> </ul> </li> <li><b>57</b> Warranty</li> </ul> |
|--|---|

## PLEASE READ AND SAVE THIS GUIDE

Thank you for purchasing an Electrolux appliance. You've chosen a product that brings with it decades of professional experience and innovation. Ingenious and stylish, it has been designed with you in mind. So whenever you use it, you can be safe in the knowledge that you'll get great results every time.

This Use & Care Guide is part of our commitment to customer satisfaction and product quality throughout the service life of your new appliance. We view your purchase as the beginning of a relationship. To ensure our ability to continue serving you, please use this page to record important product information.

## CUSTOMER CARE AND SERVICE

Keep a Record for Quick Reference

---

**Purchase Date**

---

**Electrolux model number**

---

**Electrolux serial number**

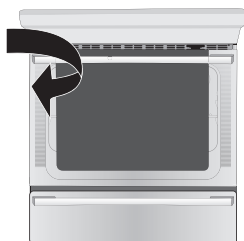

When contacting Service, ensure that you have the following data available. The information can be found on the rating plate. Serial plate location: open oven drawer (some models) or warmer drawer (some models). We recommend the use of original spare parts. Registering your product with Electrolux enhances our ability to serve you. You can register online at [www.electroluxappliances.com](http://www.electroluxappliances.com) or by dropping your Product Registration Card in the mail. For toll-free telephone support in the U.S. and Canada: 1-877-4ELECTROLUX (1-877-435-3287).

### On the Electrolux Website

Want to learn more about your product or discover additional Electrolux appliances? If so, then check out the link below for product overviews, a list of features, photo galleries, product manuals (complete owner's guide, installation instructions, wiring diagrams, product spec sheets), specifications, reviews, related accessories, and video guides.

For online support and Internet production information, visit <http://www.electroluxappliances.com>

[www.electrolux.com](http://www.electrolux.com)

1-877-435-3287

## Important Safety Instructions

Read all instructions before using this appliance.  
Save these instructions for future reference.

This manual contains important safety symbols and instructions. Please pay attention to these symbols and follow all instructions given.

Do not attempt to install or operate your appliance until you have read the safety precautions in this manual. Safety items throughout this manual are labeled with a WARNING or CAUTION statement based on the risk type.

### DEFINITIONS

This is the safety alert symbol. It is used to alert you to potential personal injury hazards. Obey all safety messages that follow this symbol to avoid possible injury or death.

#### WARNING

Indicates a potentially hazardous situation which, if not avoided, may result in death or serious injury.

#### CAUTION

Indicates a potentially hazardous situation which, if not avoided, may result in minor or moderate injury.

**IMPORTANT!** Indicates installation, operation, maintenance, or valuable information that is not hazard related.



#### **General Information, Important, Hints and Tips**

Indicates useful information to avoid malfunctions and is also used for hints and tips how the appliance works in the best way. Information icon followed by supporting text.

#### WARNING

**Storage In or On Appliance**—Flammable materials should not be stored in an oven or near surface units. This includes paper, plastic, and cloth items, such as cookbooks, plastic ware, and towels, as well as flammable liquids. Do not store explosives, such as aerosol cans, on or near the oven.

#### WARNING

**Do Not Leave Children Alone** - Children should not be left alone or unattended in the area where appliance is in use. They should never be allowed to sit or stand on any part of the appliance, including the storage drawer, lower broiler drawer, warmer drawer, or lower double oven.

#### WARNING

Never cover any slots, holes, or passages in the oven bottom or cover an entire oven rack with materials, such as aluminum foil. Aluminum foil linings may trap heat, causing a fire hazard.

** WARNING** If the information in this manual is not followed exactly, a fire or explosion may result causing property damage, personal injury or death.

### FOR YOUR SAFETY:

- Do not store or use gasoline or other flammable vapors and liquids in the vicinity of this or any other appliance.
- WHAT TO DO IF YOU SMELL GAS:
  - Do not try to light any appliance.
  - Do not touch any electrical switch; do not use any phone in your building.
  - Immediately call your gas supplier from a neighbor's phone. Follow the gas supplier's instructions.
  - If you cannot reach your gas supplier, call the fire department.
- Installation and service must be performed by a qualified installer, servicer or the gas supplier.

#### WARNING

Stepping, leaning, or sitting on the door or drawers of an oven can result in serious injuries and also cause damage to the appliance. Do not allow children to climb or play around the oven. The weight of a child on an open oven door may cause the oven to tip, resulting in serious burns or other injury.

#### CAUTION

Wear proper apparel. Loose-fitting or hanging garments should never be worn while using this appliance. Do not let clothing or other flammable materials come into contact with hot surfaces.

#### CAUTION

Do not heat unopened food containers. Build-up of pressure may cause container to burst and result in injury.

#### CAUTION

Do not use water or flour on grease fires. Smother fire or flame or use dry chemical or foam-type extinguisher. Cover the fire with a pan lid or use baking soda.

## Important Safety Instructions

### ⚠ WARNING

### Tip Over Hazard

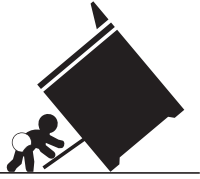

- A child or adult can tip the appliance and be killed.
- Verify the device is engaged with the countertops or that the device has been

installed to the walls of the cabinet, the wall, or the floor as per the installation instructions

- Ensure the anti-tip device is re-engaged with the countertop, the walls of the cabinet, the wall, or the floor as per the installation instructions when the appliance is moved.
- Do not operate the appliance without the anti-tip device in place and engaged.
- Failure to follow these instructions can result in death or serious burns to children and adults.



To check if the anti-tip bracket is installed properly, use both arms to grasp the rear edge of the appliance back. Carefully

attempt to tilt appliance forward. When properly installed, the appliance should not tilt forward.

Refer to the anti-tip bracket installation instructions supplied with your range for proper installation.

Air curtain or other overhead range hoods, which operate by blowing a downward air flow on to a range, shall not be used in conjunction with gas ranges other than when the hood and range have been designed, tested and listed by an independent test laboratory for use in combination with each other.

### ⚠ CAUTION

Use dry potholders. Moist or damp potholders on hot surfaces may result in burns from steam. Do not let potholders touch hot cooking areas. Do not use towels or other bulky cloths.

### ⚠ CAUTION

Do not store items of interest to children in the cabinets above a range or on the backguard of the range. Children climbing on the range to reach items could be seriously injured.

### ⚠ CAUTION

When heating fat or grease, watch it closely. Grease may catch fire if it becomes too hot.

**IMPORTANT!** Important Safety Notice - The California Safe Drinking Water and Toxic Enforcement Act requires the governor of California to publish a list of substances known to cause cancer, birth defects, or other reproductive harms, and it requires businesses to warn customers of potential exposures to such substances.

### ⚠ CAUTION

Read and follow the below instructions and precautions for unpacking, installing, and servicing your appliance:

- Remove all tape and packaging before using the oven. Destroy the carton and plastic bags after unpacking the oven. Never allow children to play with packaging material.
- Proper Installation—Be sure your appliance is properly installed and grounded by a qualified technician in accordance with the National Fuel Gas Code ANSI Z223.- latest edition, or in Canada CAN/CGA B149.1, and CAN/CGA B149.2, and the National Electrical Code ANSI/NFPA No.70-latest edition, or in Canada CSA Standard C22.1, Canadian Electrical Code, Part 1, and local code requirements. Install only per installation instructions provided in the literature package for this range.
- User Servicing—Do not repair or replace any part of the appliance unless specifically recommended in the manuals. All other servicing should be done only by a qualified technician. This reduces the risk of personal injury and damage to the oven.
- Ask your dealer to recommend a qualified technician and an authorized repair service. Know how to disconnect the power to the oven at the circuit breaker or fuse box in case of an emergency.
- Never modify or alter the construction of an oven by removing the leveling legs, panels, wire covers, anti-tip brackets/screws, or any other part of the oven.
- Remove the oven door from any unused oven if it is to be stored or discarded.

**Save these instructions for future reference.**

## Important Safety Instructions

- Be sure to have an appropriate foam-type fire extinguisher available, visible, and easily located near the appliance.
- Do not attempt to operate the oven during a power failure. If the power fails, always turn off the oven. If the oven is not turned off and the power resumes, the oven will begin to operate again. Once the power resumes, reset the clock and oven function.
- Cold temperatures can damage the electronic control. When using this appliance for the first time, or when the appliance has not been used for an extended period of time, be sure the appliance has been in temperatures above 32°F (0°C) for at least 3 hours before turning on the power to the appliance.

### IMPORTANT INSTRUCTIONS FOR USING YOUR OVEN

- Never use your appliance for warming or heating the room.
- Use care when opening oven door, lower oven door, or warmer drawer (some models). Stand to the side of the oven when opening the door of a hot oven. Let hot air or steam escape before you remove or replace food in the oven.
- Keep oven vent ducts unobstructed. Touching surfaces in this area when the oven is on may cause severe burns. Do not place plastic or heat-sensitive items on or near the oven vent. These items can melt or ignite.
- Placement of Oven Racks - Always place oven racks in desired location while oven is cool. If rack must be moved while oven is hot, do not let potholder contact hot heating element in oven. Use potholders and grasp the rack with both hands to reposition. Remove all bakeware and utensils before moving the rack.
- Do not use a broiler pan without its insert. Broiler pans and inserts allow dripping fat to drain away from the high heat of the broiler. Do not cover the broiler insert with aluminum foil; exposed fat and grease could ignite.
- Protective Liners - Do not use aluminum foil to line oven bottoms, except as suggested in the manual. Improper installation of these liners may result in a risk of electric shock, or fire.
- Do not cook food on the oven bottom. Always cook in proper bakeware and always use the oven racks.

### IMPORTANT INSTRUCTIONS FOR USING YOUR COOKTOP

#### **⚠ WARNING**

**Use Proper Flame Size** — Adjust flame size so it does not extend beyond the edge of the utensil. The use of undersized utensils will expose a portion of the burner flame to direct contact and may result in ignition of clothing. Proper relationship of utensil to flame will also improve efficiency.

- When you are flaming foods under a ventilating hood, turn on the fan.
- Know which knob controls each surface heating unit. Place a pan of food on the surface burner before turning it on, and turn the burner off before removing the pan.
- Use proper pan size. This appliance is equipped with one or more surface units of different sizes. Select cookware having flat bottoms large enough to cover the burner. The use of undersized utensils will expose a portion of the flame to direct contact and may result in ignition of clothing. Proper relationship of utensil to burner will also improve efficiency.
- Utensil handles should be turned inward and not extend over adjacent surface burners — To reduce the risk of burns, ignition of flammable materials, and spillage due to unintentional contact with the utensil, the handle of the utensil should be positioned so that it is turned inward, and does not extend over adjacent surface units.
- Never leave surface burners unattended at high heat settings — Boilovers cause smoking and greasy spillovers that may ignite, or a pan that has boiled dry may melt.
- Glazed cooking utensils — Only certain types of glass, glass/ceramic, ceramic, earthenware, or other glazed utensils are suitable for cook top service without breaking due to the sudden change in temperature. Check the manufacturer's recommendations for cook top use.
- Improper cookware may break due to sudden changes in temperature. Check the cookware manufacturer's recommendations for cooktop use.

**Save these instructions for future reference.**

## Important Safety Instructions

- Do not use decorative surface burner covers. If a burner is accidentally turned on, the decorative cover will become hot and possibly melt. Burns will occur if the hot covers are touched. Damage may also be done to the cooktop.
- Always turn knob to the full LITE position when igniting top burners. Visually check that burner has lit. Then adjust the flame so it does not extend beyond the edge of the utensil.

### IMPORTANT INSTRUCTIONS FOR CLEANING YOUR OVEN

#### **⚠ CAUTION**

Before manually cleaning any part of the oven, be sure all controls are turned off and the oven is cool. Cleaning a hot oven can cause burns.

Clean the oven regularly to keep all parts free of grease that could catch fire. Do not allow grease to accumulate.

Always follow the manufacturer's recommended directions for use of kitchen cleaners and aerosols. Be aware that excess residue from cleaners and aerosols may ignite causing damage and injury.

Clean ventilating hoods frequently. Grease should not be allowed to accumulate on the hood or filter. Follow the manufacturer's instructions for cleaning hoods.

### SELF-CLEANING OVENS

- Clean only the parts listed in this manual. Before using self-clean, remove the broiler pan, any food, utensils, and bakeware from the oven. Remove oven racks unless otherwise instructed.
- Do Not Use Oven Cleaners. No commercial oven cleaner or oven liner protective coating of any kind should be used in or around any part of the oven.
- Do Not Clean Door Gasket. The door gasket is essential for a good seal. Care should be taken not to rub, damage, or move the gasket.
- Some birds are extremely sensitive to the fumes given off during the self-clean cycle of any oven. Move birds to another well-ventilated room.

#### **⚠ CAUTION**

**DO NOT TOUCH HEATING ELEMENTS OR INTERIOR SURFACES OF OVEN** - Heating elements may be hot even though they are dark in color. Interior surfaces of an oven become hot enough to cause burns. During and after use, do not touch, or let clothing or other flammable materials contact heating elements or interior surfaces of oven until they have had sufficient time to cool. Other surfaces of the appliance may become hot enough to cause burns - among these surfaces are (identification of surfaces - for example, oven vent openings and surfaces near these openings, oven doors, and windows of oven doors).

### CONVERSION TO L.P. GAS

#### **⚠ WARNING**

Personal injury or death from electrical shock may occur if the conversion to L.P. gas is not made by a qualified installer or electrician.

#### **⚠ WARNING**

Any additions, changes or conversions required in order for this appliance to satisfactorily meet the application needs must be made by a qualified technician.

This appliance allows for conversion to Liquefied Petroleum (L.P.) Gas.

If L.P. conversion is needed, contact your local L.P. Gas provider for assistance. The L.P. conversion kit is provided with this appliance and is located on the lower REAR (back side) panel of the range. Before installing the kit be sure to read the L.P. Installation Instructions and follow them carefully when making the installation.

**Save these instructions for future reference.**

## Important Safety Instructions

### GROUNDING INSTRUCTIONS: ELECTRIC MODELS WITH NO FACTORY-SUPPLIED POWER CORD

#### **⚠ WARNING**

Avoid fire hazard or electrical shock. Failure to follow this warning may cause serious injury, fire, or death.

For personal safety, this appliance must be properly grounded. For maximum safety, the power cord must be plugged into an electrical outlet that is the correct voltage, is correctly polarized and properly grounded in accordance with local codes. It is the personal responsibility of the consumer to have the appropriate outlet with the correct, properly grounded wall receptacle installed by a qualified electrician. It is the responsibility and obligation of the consumer to contact a qualified installer to assure that the electrical installation is adequate and is in conformance with all local codes and ordinances.

See the installation instructions packaged with this appliance for complete installation and grounding instructions.

### GROUNDING INSTRUCTIONS: CANADIAN ELECTRIC MODELS

For models factory-equipped with a power cord:

#### **⚠ WARNING**

Avoid fire hazard or electrical shock. Failure to follow this warning may cause serious injury, fire, or death.

For personal safety, this appliance must be properly grounded. For maximum safety, the power cord must be plugged into an electrical outlet that is the correct voltage, is correctly polarized and properly grounded in accordance with local codes.

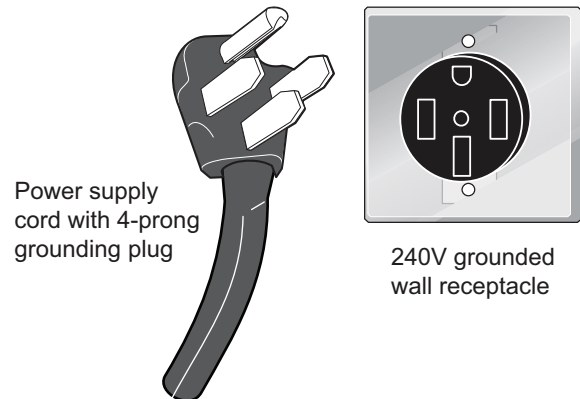

It is the personal responsibility of the consumer to have the appropriate outlet with the correct, properly grounded wall receptacle installed by a qualified electrician.

#### **⚠ WARNING**

Avoid fire hazard or electrical shock. Do not use an adapter plug, use an extension cord, or remove grounding prong from the power cord. Failure to follow this warning may cause serious injury, fire, or death.

See the installation instructions packaged with this appliance for complete installation and grounding instructions.

**Save these instructions for future reference.**

# BEFORE SETTING SURFACE CONTROLS

## Using Proper Cookware

### ⚠ CAUTION

Surface burners may appear to have cooled after they have been turned off. The surface burner may still be hot and burns may occur if the surface burner is touched before it has cooled sufficiently.

For best cooking results, cookware should have flat bottoms that rest level on the surface burner grate. Before using cookware, check for flatness by rotating a ruler across the bottom of the cookware (Figure 1). Specialty pans such as lobster pots, griddles, and pressure cookers may be used but must conform to these recommended cookware requirements.

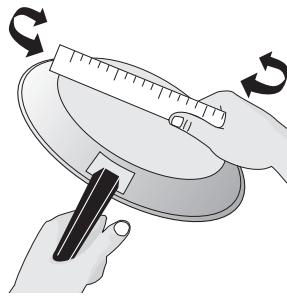

Figure 1: Testing Cookware

### CORRECT



- Flat bottom and straight sides.
- Tight fitting lids.
- Weight of handle does not tilt pan. Pan is well balanced.
- Pan sizes match the amount of food to be prepared.
- Made of material that conducts heat well.
- Easy to clean.

### INCORRECT

- Curved and warped pan bottoms.



- Pan overhangs unit by more than 2.5 cm (1").



- Heavy handle tilts pan.



- Flame extends beyond unit.



Figure 2: Cookware recommendations

### IMPORTANT!

The size and type of utensil used, and the amount and type of food being cooked will influence the burner flame setting needed for best cooking results.



Always use a utensil for its intended purpose. Follow manufacturer's instructions. Some utensils were not made to be used in the oven or on the cooktop.

## Cookware Material Types

The cookware material determines how evenly and quickly heat is transferred from the surface burner to the pan bottom. The most popular materials available are:

Aluminum - Excellent heat conductor. Some types of food will cause it to darken (Anodized aluminum cookware resists staining and pitting).

Copper - Excellent heat conductor but discolors easily (See Aluminum).

Stainless - Slow heat conductor with uneven cooking results. Is durable, easy to clean and resists staining.

Cast Iron - A slow heat conductor however will retain heat very well. Cooks evenly once cooking temperature is reached.

Porcelain-enamel on metal - Heating characteristics will vary depending on base material.

Glass - Slow heat conductor.

## Using a Wok (not supplied)

### ⚠ CAUTION

Do not use a wok if it is equipped with a metal ring that extends beyond the burner unit. Because this ring traps heat, the surface unit and cooktop surface could be damaged.

Woks with flat bottoms suitable for use on your cooktop are available in most cookware or hardware stores. Round bottomed woks (with a support ring that does not extend beyond the burner unit) may also be used. The metal ring was designed to support the wok safely when it is filled with large amounts of liquids (soup making) or fat (frying).

Wire trivets: Do not use wire trivets. Cookware bottoms must be in direct contact with the grates.



Figure 3: Wok recommendations



## BURNER CAP PLACEMENT

Check burner cap placement before operating the surface burners.

### ⚠ WARNING

To prevent flare-ups and avoid creation of harmful by-products, do not use the cooktop without all burner caps properly installed to insure proper ignition and gas flame size. Turn the burner on to determine if it will light. If the burner does not light, contact a Service Center. Do not service the sealed burner yourself.

It is very important to be sure that all surface burner caps and burner grates are properly installed and in the correct locations before operating the cooktop burners.



The color of the flame is the key to proper burner adjustment. A good flame is clear, blue and hardly visible in a well-lighted room. Each cone of flame should be steady and sharply defined. Adjust or clean burner if flame is yellow-orange. To clean burner, see [“Cleaning Surface Burner Heads”](#) on page 50.

#### For all Burners:

- Place a burner cap on each burner head (Figure 4), matching the cap size to the head size. The cap for each burner has an inner locating ring which centers the cap correctly on the burner head. Be sure that all the burner caps and burner heads are correctly placed BEFORE using your appliance.
- Always keep surface burner caps in place whenever using a surface burner.
- When placing the burner caps, be sure that all burner caps are seated firmly and rest level on top of burner heads.
- For proper flow of gas and ignition of burners do not allow spills, food, cleaning agents or any other material to enter the gas orifice port opening.
- Burner heads are fixed. Do not try to remove them.

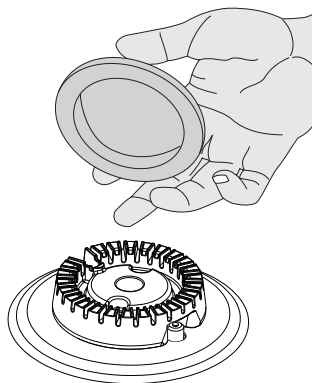

Figure 4: Burner cap and head

On round style burners, the burner cap lip (Figure 5) should fit snug into the center of burner head and rest level.

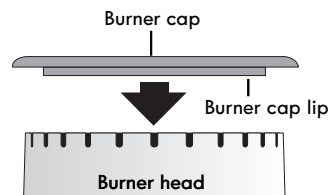

Figure 5: Burner cap lip placement

Refer to Figure 7 for correct and incorrect burner cap placement.

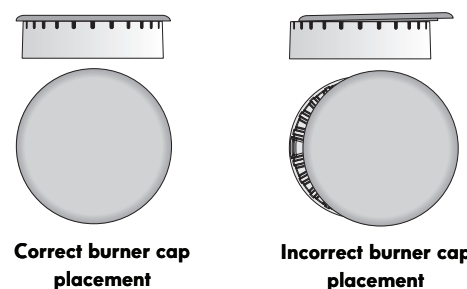

Figure 6: Correct & Incorrect burner cap placement

Once in place, you may check the fit by gently sliding the burner cap from side to side to be sure it is centered and firmly seated (Figure 7). When the burner cap lip makes contact inside the center of the burner head you will be able to hear the burner cap click. Please note that the burner cap should NOT move off the center of the burner head when sliding from side to side.

Check and be sure that all oval style (some models) burner caps are correctly in place on oval burner heads.

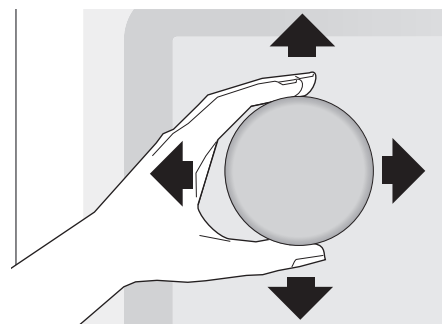
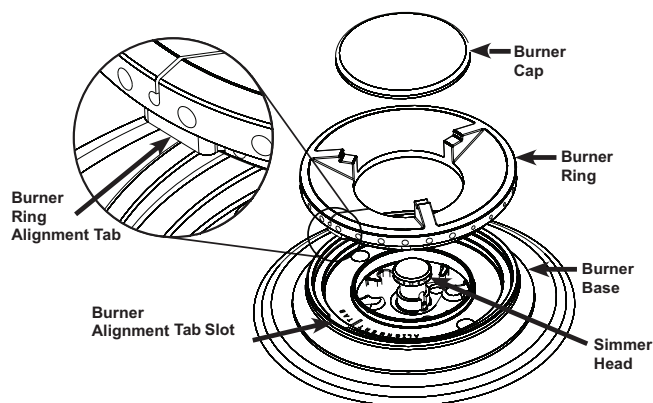

Figure 7: Checking the fit

**For the 18 000 BTU burner:**

Place the burner head over the gas orifice (Figure 8). Be careful not to damage the electrode while placing the burner head over the orifice. Make sure electrode fits correctly into slot in burner head.

**IMPORTANT!** For proper ignition, the burner ring alignment tab must align with burner base alignment tab slot.



**Figure 8: Setting G5 burner correctly**

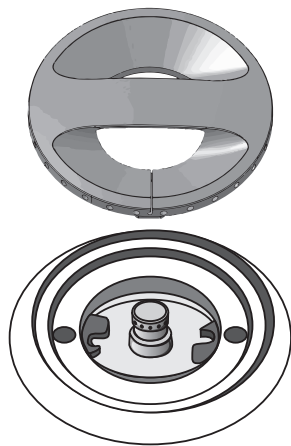

**Figure 9: 18 000 BTU burner cap and head**



When the burner ring is properly seated, it will click into place. When the burner cap is properly set in place, it should not move out of the recessed area of the burner head.

**INSTALLING BURNER GRATES****⚠ CAUTION**

Surface burners may appear to have cooled after they have been turned off. The surface burner may still be hot and burns may occur if the surface burner is touched before it has cooled sufficiently.

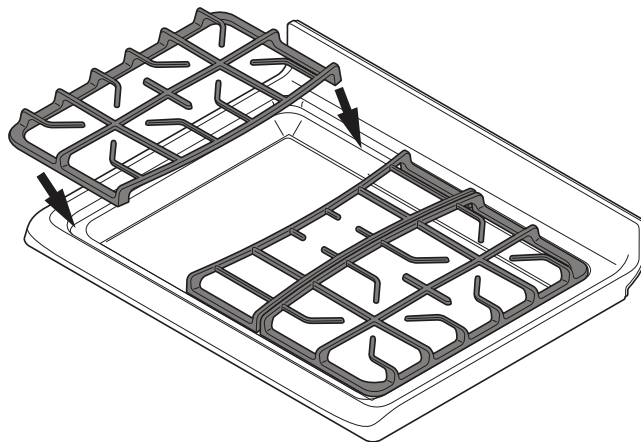

**Figure 10: Burner grates placement**

Make sure the burner grates are properly placed on the cooktop before using the surface burners. The grates are designed to rest inside the recess on the cooktop.

To install burner grates, place grates flat-side down and align into the cooktop recess. Grates should rest flush against each other and against the sides of the recess (Figure 10).

# SETTING SURFACE CONTROLS

## Types of Cooktop Surface Burners

The cooktop comes with a variety of burners to accommodate different sizes of cookware. The ability to heat food quicker and in larger volumes increases as the burner size increases. It is important to select cookware that is suitable for the amount and type of food being prepared

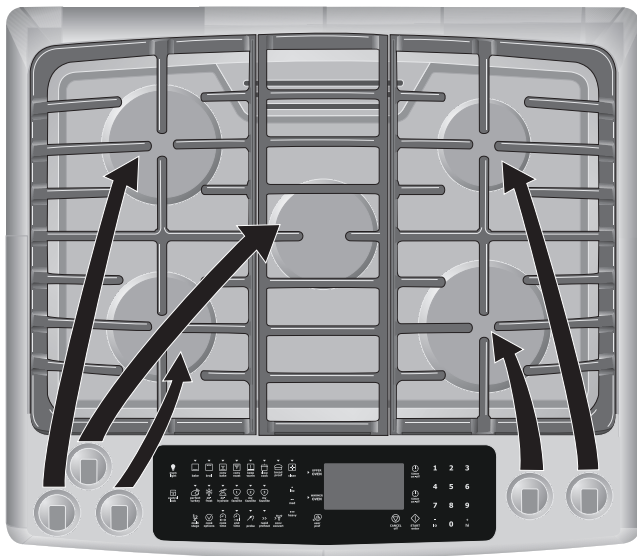

Figure 11: Surface burner types

### Cooktop Surface Burners, by Size and Type

The surface burners are located on the cooktop as follows (Figure 11):

- a 5 000 BTU (natural gas) burner located at the right rear position;
- a 18 000 BTU (natural gas) dual-flame burner located at the right front position;
- a 9 500 BTU (natural gas) burner located at the left front position;
- a 16 000 BTU (natural gas) burner located at the left rear position;
- a 9 500 BTU (natural gas) burner located at the center position.

## SETTING PROPER BURNER FLAME SIZE

### CAUTION

Never extend the flame beyond the outer edge of the cooking utensil. A higher flame wastes energy, and increases your risk of being burned by the flame.

The color of the flame is the key to proper burner adjustment. A good flame is clear, blue and hardly visible in a well-lighted room. Each cone of flame should be steady and sharp. Adjust or clean burner if flame is yellow-orange.

For most cooking: start on the highest setting and then turn to a lower setting to complete the process. Use the recommendations in Table 1 as a guide for determining proper flame size for various types of cooking.)

For deep fat frying: use a thermometer and adjust the surface knob accordingly. If the fat is too cool, the food will absorb the fat and be greasy. If the fat is too hot, the food will brown so quickly that the center will be under cooked. Do not attempt to deep fat fry too much food at once as the food will neither brown or cook properly

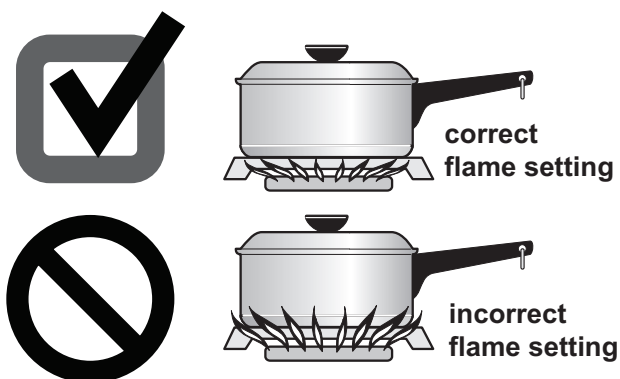

Figure 12: Correct and incorrect flame setting

Table 1: Flame size recommendations

Flame Size*	Type of Cooking
High flame	Start most foods; bring water to a boil; pan broiling
Medium flame	Maintain a slow boil; thicken sauces; gravies; steaming
Low flame	Keep foods cooking; poach; stewing

\*These settings are based for medium-weight metal or aluminum pans with lids. Settings may vary when using cookware made from different materials.

### IMPORTANT!

Specialty pans such as lobster pots, griddles and pressure cookers may be used but must conform to the above recommended cookware requirements.

## SETTING SURFACE CONTROLS

Your cooktop may be equipped with any combination of the following burners:

- Simmer Burner: best used for simmering delicate sauces, etc.
- Standard Burner: used for most all surface cooking needs.
- Large Burner: best used when bringing large quantities of liquid to temperature and when preparing larger quantities of food.
- Your cooktop is also equipped with 270° rotation flame control valves. These valves provide enhanced control of the burner flame. Each burner lights automatically from an electric ignitor when its control knob is turned to the LITE position



Regardless of size, always select a utensil that is suitable for the amount and type of food being prepared. Select a burner and flame size appropriate to the pan. Never allow flames to extend beyond the outer edge of the pan.



Figure 13: Regular burner control knob

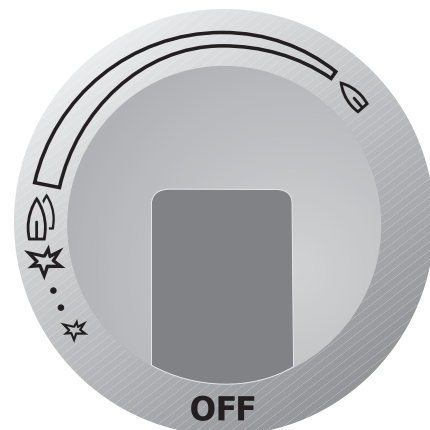

Figure 14: Dual burner control knob

To operate the surface burner:

### ⚠ CAUTION



Do not place flammable items such as plastic salt and pepper shakers, spoon holders or plastic wrappings on the cooktop when it is in use. These items could melt or ignite. Potholders, towels or wooden spoons could catch fire if placed too close to the range cooktop.

### ⚠ CAUTION

Do not place aluminum foil, or ANY material that can melt on the range cooktop. If these items melt they may permanently damage the cooktop surface.

### ⚠ CAUTION

When operating the oven, it is possible for residual heat from the oven to build-up and over time to eventually transfer to the surface control knobs located directly above the oven door.

1. Place cooking utensil on burner.
2. Push in and turn the Surface Control knob to (LITE). For dual flame burner, make sure to keep the knob setting between the two icons 
3. Visually check that the burner has lit.
4. Turn the control knob to the desired flame size. The control knobs do not have to be set at a particular mark. Use the guides and adjust the flame as needed. 

### IMPORTANT!

- Do not cook with the surface control knob left in the LITE position. The electronic ignitor will continue to spark if the control knob setting remains in the LITE position.
- When setting any surface control knob to the LITE position, all electronic surface ignitors will spark at the same time. However, only the surface burner you are setting will ignite.
- Never place or straddle a cooking utensil over two different surface cooking areas at the same time unless the utensil or cookware was designed for that purpose, such as a griddle. This can cause uneven heating results.
- In the event of an electrical power outage, the surface burners can be lit manually. To light a surface burner, hold a lit long match to the burner head, then slowly turn the surface control knob to LITE. After burner lights, turn knob to desired setting. Use caution when lighting surface burners manually.

## Using the Griddle (Some Models)

The griddle is intended for direct food cooking and can be used on both sides. Do not use pans or other cookware on the griddle. Doing so could damage the finish. Center the griddle over the simmer oval burner.

### ⚠ CAUTION

Surface burners may appear to have cooled after they have been turned off. The surface burner may still be hot and burns may occur if the surface burner is touched before it has cooled sufficiently.

### ⚠ CAUTION

Never place or straddle a cooking utensil over two different surface cooking areas at the same time unless the cooktop is designed for such a purpose.

### ⚠ CAUTION

Always place the griddle on the grate before lighting the burner. Be sure the griddle is positioned correctly and stable before use to prevent hot spills and possible burns.

### ⚠ CAUTION

Always use potholders to remove the griddle from the grate. Allow the griddle to cool before removing. Do not set hot griddle on surfaces that cannot withstand high heat, such as a counter top

### ⚠ CAUTION

Be sure the griddle is positioned correctly and stable before use to prevent hot spills and possible burns.

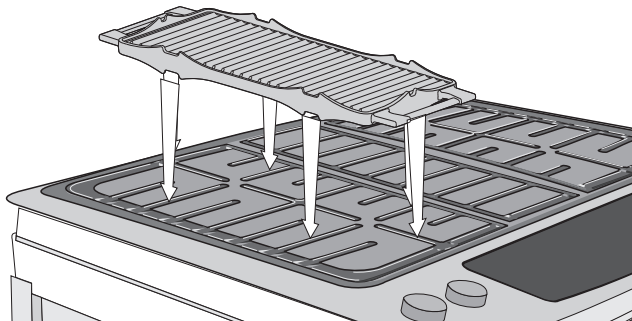

Figure 15: Griddle cooktop placement

## HOME CANNING

### ⚠ CAUTION

Canning can generate large amounts of steam. Use extreme caution to prevent burns. Always raise the lid to vent steam away from you. Safe canning requires that harmful micro-organisms are destroyed and the jars are sealed completely. When canning in a water bath canner, a gentle but steady boil must be maintained continuously for the required time.

Be sure to read and observe all the following points when home canning with your appliance. Check with the USDA (United States Department of Agriculture) Web site and be sure to read all the information they have available as well as follow their recommendations for home canning procedures.

- Use only quality flat bottom canners when home canning. Use a straight-edge to check canner bottom.
- Use only a completely flat bottom canner with no ridges that radiate from the bottom center when home canning. Heat is spread more evenly when the bottom surface is flat.
- Start with hot tap water to bring water to boil more quickly.
- Use the highest heat setting when first bringing the water to a boil. Once boiling is achieved, reduce heat to lowest possible setting to maintain that boil.
- Use tested recipes and follow instructions carefully. Check with your local Cooperative Agricultural Extension Service or a manufacturer of glass jars for the latest canning information.
- It is best to can small amounts and light loads.
- Do not leave water bath or pressure canners on high heat for an extended amount of time.
- Alternate surface units between each batch to allow the units and surrounding surfaces to cool down. Try to avoid canning on the same burner unit all day.

# BEFORE SETTING OVEN CONTROLS

## Oven Vents

The oven is vented above each door. When the oven is on, warm air passes through this vent. This venting is necessary for proper air circulation in the oven and good baking results. Do not block oven vent. Steam or moisture may appear near the oven vent. This is normal.

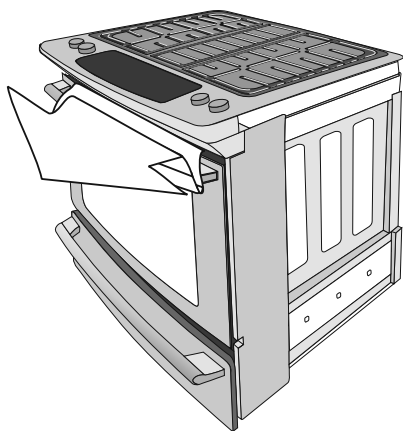

**Figure 16: Oven vent location**



Some models are equipped with a cooling fan that runs during the cooking process to cool internal electronic components. It is normal for this fan to continue to run for an extended period of time, even when the oven is off.

### **CAUTION**

Do not line the oven walls, racks, bottom, or any other part of the oven with aluminum foil. Doing so will alter heat distribution, produce poor baking results, and may cause permanent damage to the oven interior. During self clean temperatures, the oven will be hot enough to melt foil.

### **CAUTION**

Always use potholders or oven mitts when removing food or adjusting the oven racks. Wait until the oven is completely cooled if possible. Oven racks may be very hot and may cause burns.

## Arranging, Removing, and Replacing Flat or Offset Oven Racks

- To Arrange: Always arrange the oven racks when the oven is cool (prior to operating the oven).
- To Remove: Pull the oven rack straight forward until it reaches the stop position. Lift up front of oven rack slightly and slide out.
- To Replace: Place the oven rack on the rack guides on the oven walls. Tilt the front of the rack upward slightly and slide the oven rack back into place.

## Types of Oven Racks

### Flat Oven Rack

Flat oven racks (or the flat handle oven rack) may be used for most cooking needs and may be placed in most oven rack positions.

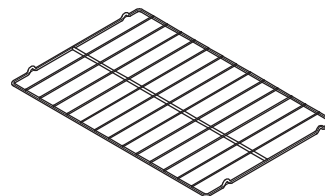

**Figure 17: Flat oven rack**

### IMPORTANT!

The two, flat handle oven racks are lubricated porcelain oven racks, which can remain in the oven during the self-clean cycle. Do not clean this vegetable oil lubrication off the racks. It is important that the sides of the oven racks always have a light coating of vegetable oil. To maintain optimal rack performance, re-apply a thin layer of vegetable oil to the sides of the rack after every self-clean cycle or when the rack becomes difficult to slide.

### Luxury-Glide™ Oven Rack

The fully extendable Luxury-Glide™ oven rack allows you to effortlessly extend your food away from the oven.

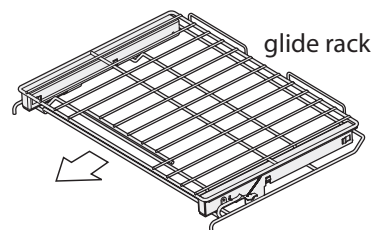

**Figure 18: Luxury-Glide™ Oven Rack**

### IMPORTANT!

The Glide Rack is porcelain enameled and may be left in the oven to be cleaned during the self-clean cycle. After the cycle, or anytime the gliding is rough, the Glide Rack extension tracks should be treated with graphite lubrication.

## Air Circulation in the Oven

For best air circulation and baking results allow 2-4" (5-10 cm) around the cookware for proper air circulation and be sure pans and cookware do not touch each other, the oven door, sides or back of the oven cavity. The hot air must circulate around the pans and cookware in the oven for even heat to reach around the food.

## LUXURY GLIDE™ OVEN RACKS

The fully extendable Luxury-Glide™ rack makes food preparation easier. This oven rack has glide tracks that allow the rack to be pulled away from the oven without rubbing the sides of the oven wall.

### Removing and Replacing the Luxury-Glide™ Oven Racks

#### To remove the oven Glide Rack:

##### ⚠ CAUTION

Always use potholders or oven mitts when removing food or adjusting the oven racks. Wait until the oven is completely cooled if possible. Oven racks may be very hot and may cause burns.

##### ⚠ CAUTION

Always remove/replace the oven racks before turning on the oven (when the oven is cool).

1. Using one hand, reach through handle opening and lift up on the release lever located across the lower front of the rack as shown in [Figure 19](#).
2. While holding up the release lever, pull the glide rack out of the oven until the stop position is reached ([Figure 20](#)), using two hands if necessary.
3. Using both hands, grasp the upper and lower portions of the glide rack ([Figure 21](#)).
4. Lift up the front of the rack slightly and continue to pull the rack away from the oven.
5. Be sure to grasp both upper and lower rack portions together when removing or handling the glide rack. The rack portions move independently and are difficult to handle unless held together.

#### To replace the oven Glide Rack:

##### ⚠ CAUTION

Always use potholders or oven mitts when removing food or adjusting the oven racks. Wait until the oven is completely cooled if possible. Oven racks may be very hot and may cause burns.

##### ⚠ CAUTION

Always remove/replace the oven racks before turning on the oven (when the oven is cool).

1. Grasp both upper and lower portions of glide rack ([Figure 21](#)).
2. Lift and hold the rack level between the oven cavity walls.
3. Tilt the front of the rack upward slightly and slide the rack completely into position. Some force may be necessary to make sure the oven rack has snapped completely into place.

### IMPORTANT!

The Glide Rack is porcelain enameled and may be left in the oven to be cleaned during the self-clean cycle. After the cycle, or anytime the gliding is rough, the glide rack extension tracks should be treated with graphite lubrication.

To prevent possible damage to the oven, do not attempt to close the oven door until all the oven racks are fully positioned back inside the oven cavity.

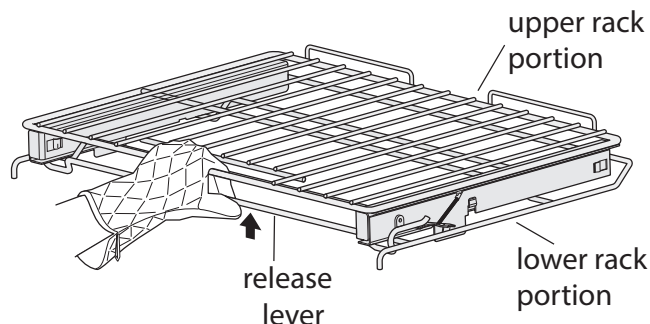

Figure 19: Luxury-Glide™ extendable oven rack

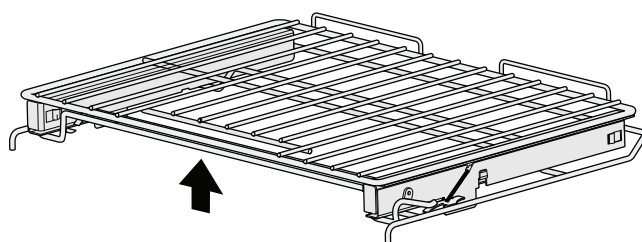

Figure 20: Removing the oven rack

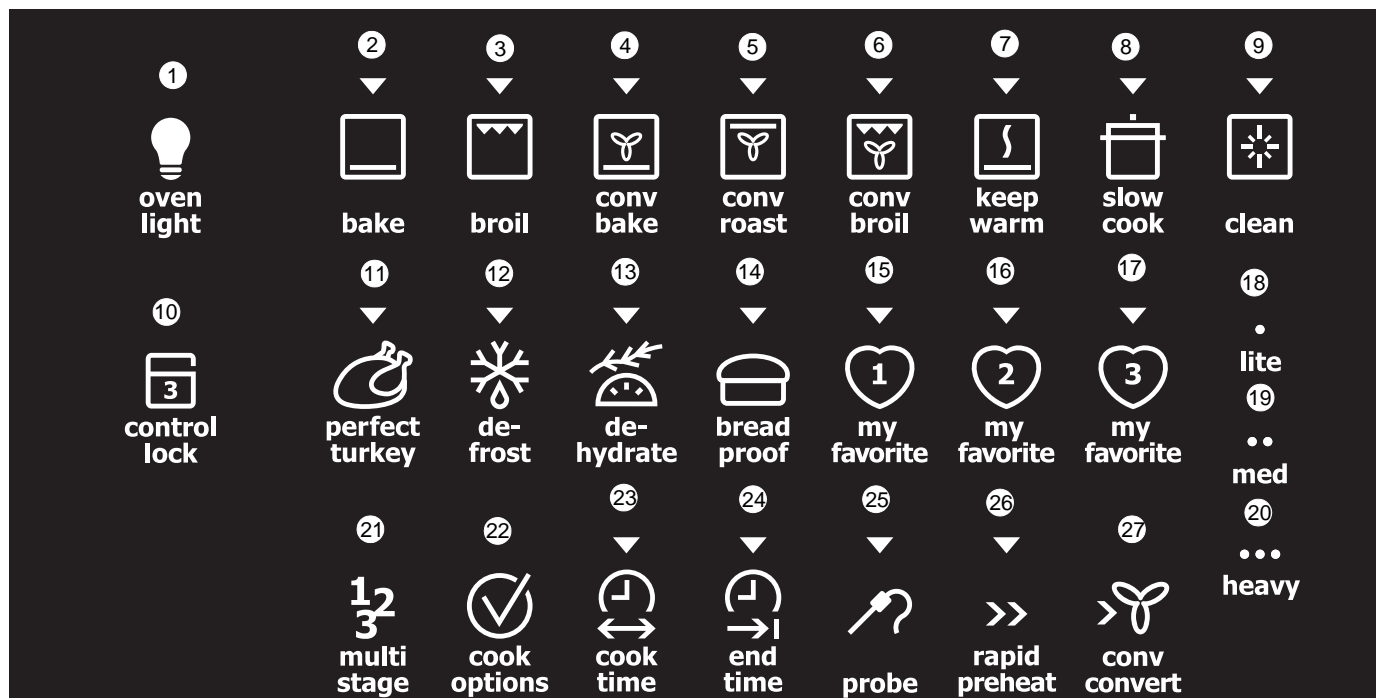

Figure 21: Replacing the oven rack



Clean oven racks according to the instructions provided in the "Caring for Your Glide Racks" section on [page 51](#).

# SETTING OVEN CONTROLS



- Oven Light** - Use to turn the internal "theater" style oven light on and off.
- Bake** - Use to enter the normal baking mode temperature and start a normal bake function, at any temperature from 170°F to 550°F (76°C to 288°C).
- Broil** - Use to select the broil function, at any temperature from 300°F to 550°F (148°C to 288°C).
- Conv Bake** - Use to select the convection baking function, which is used to obtain the best culinary results when baking with multiple pans and racks at any temperature from 170°F to 550°F (76°C to 288°C).
- Conv Roast** - Use to select the convection roasting function, best for cooking tender cuts of beef, lamb, pork, and poultry. Use this mode when cooking speed is desired at any temperature from 170°F to 550°F (76°C to 288°C).
- Conv Broil** - Use to select the convection broil function, best for thicker cuts of meat, fish, and poultry. Uses the broil element and a fan to circulate heat evenly and continuously at any temperature from 300°F to 550°F (148°C to 288°C).
- Keep Warm** - Use to select the keep warm function, best for keeping oven cooked foods warm after cooking has finished at any temperature from 150°F to 190°F (66°C to 86°C).
- Slow Cook** - Use to select the slow cook function, which cooks food more slowly, at lower temperatures and provides cooking results much the same way as a Slow Cooker or Crock-Pot.
- Clean** - Use to select the self cleaning function.
- Control Lock** - Use to disable all oven functions by locking the oven door and control panel.
- Perfect Turkey** - Use to select the perfect turkey function, which uses the meat probe to control precisely the cooking of a perfect turkey using the convection system to brown the exterior and seal in the juices.
- Defrost** - Use to select the defrost function, which is used to thaw small portions of delicate items such as cream cakes, frozen cream pies, and cheesecake at room temps.
- Dehydrate** - Use to select the dehydrate function, which dries foods with heat from the bake and the convection elements, circulating heat throughout the oven by the convection fan.
- Bread Proof** - Use to select the bread proof function, which prepares the dough for baking by activating the yeast.
- My Favorite 1** - Use each of the three my favorite function keys to save your most used and complex cooking sequences, spanning cooking mode, target temperature, and cook time (if any).
- My Favorite 2** - The oven can recall up to three cooking sequences from its internal memory. Use the second my favorite function key to save or recall your second pre-programmed cooking sequence.
- My Favorite 3** - Use the third my favorite function key to save or recall your third pre-programmed cooking sequence.
- Lite (Self Clean Cycle)** - Use to start a 2-hour self clean cycle.
- Med (Self Clean Cycle)** - Use to start a 3-hour self clean cycle.
- Heavy (Self Clean Cycle)** - Use to start a 4-hour self clean cycle.



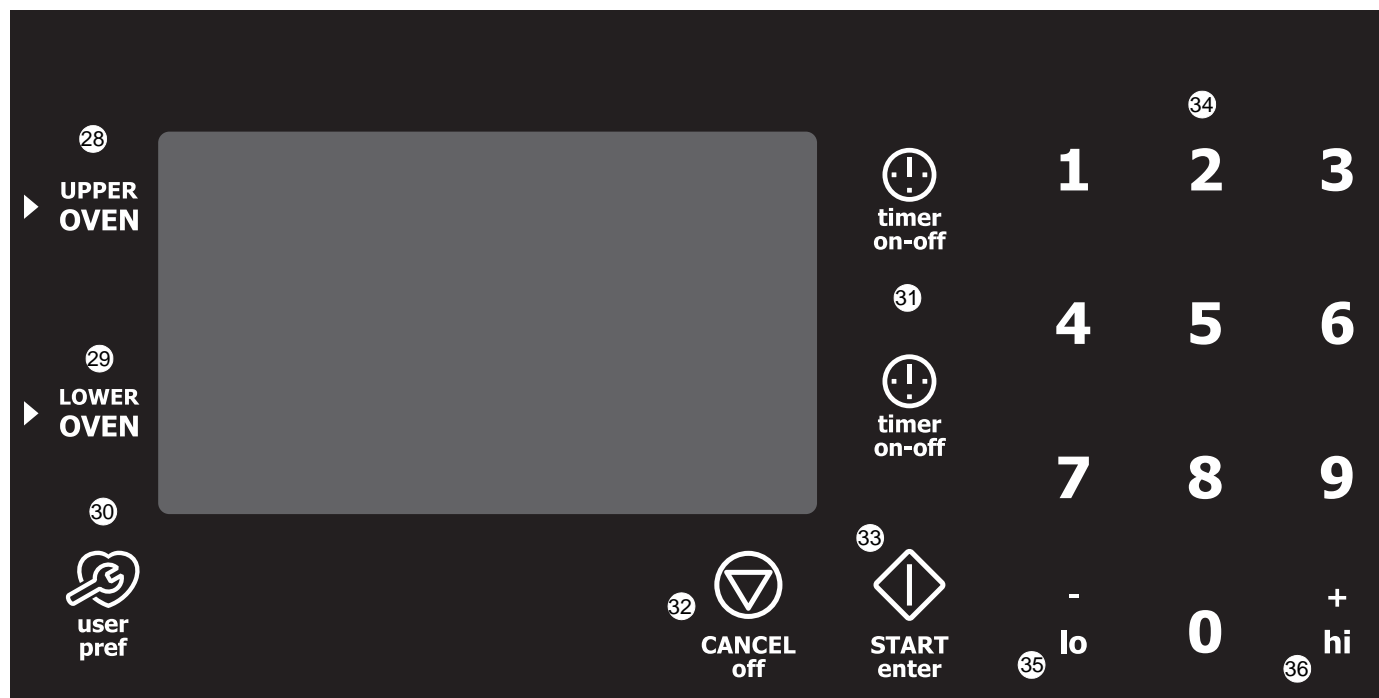

- 21. Multi Stage** - Use to enter up to three subsequent functions, to program a queue of up to three cooking modes with individual cooking times and temperatures.
- 22. Cook Options** - Use to light up the cooking options functions, such as cook time.
- 23. Cook Time** - Use to set a cooking duration time with an auto shut off.
- 24. End Time** - Use to select the time at which the cooking will end. It allows the oven to be set to shut off automatically at a set time of the day.
- 25. Probe** - Use to activate the meat probe function, enabling you to test internal food temperature at any temperature from 130°F to 210°F (54°C to 98°C).
- 26. Rapid Preheat** - Use to quickly preheat the oven temperature to any temperature from 170°F to 550°F (76°C to 288°C).
- 27. Conv Convert** - Use to convert a standard baking recipe temperature to a temperature for convection baking.
- 28. Upper Oven** - Use to light up the cooking modes functions for the upper oven.
- 29. Lower Oven** - Use to light up the cooking modes functions for the lower oven.
- 30. User Pref** - Use to bring the user preference menu in the display. Available when the oven is not being used, use this function to set such options as time of day, audio control, and many more.
- 31. Timers On-Off** - Use to set or cancel the minute timer, one for each oven. The minute timer does not start or stop cooking.
- 32. CANCEL Off** - Use to cancel any function previously entered except the time of day and minute timer. Push the **CANCEL off** key to stop cooking.
- 33. START Enter** - Use to start all oven functions.
- 34. 0 thru 9** - Use to enter temperature and times.
- 35. -lo** - Use to lower the temperature and times. This key is used in conjunction with the **+hi** key to set the Sabbath feature.
- 36. +hi** - Use to raise the temperature and times. This key is used in conjunction with the **-lo** key to set the Sabbath feature.



This range is equipped with a lower, mini oven. Available cooking functions for this mini oven are bake, keep warm, and slow cook. The available cooking options are cook time, end time, and favorites. See ["The Lower Oven"](#) on page [page 40](#) for instructions on mini oven use.

## Choosing and Setting an Oven

Both the upper and lower ovens may be set to cook at the same time using different functions. For example, you may want to broil in the upper oven while using the keep warm function in the lower oven at the same time. First, select which oven you want to set or modify by pressing either **UPPER OVEN** or **LOWER OVEN**. Then, follow the instructions in this guide to set the desired cooking functions.

The display will indicate which oven is currently available to be set by displaying a small red triangle indicator next to the UPPER OVEN or LOWER OVEN keys on the control.

If the UPPER OVEN key displays the red triangle indicator but you wish to set or change the settings for the lower oven, press **LOWER OVEN** once to change the oven selection. Then make the setting/changes. You may toggle between either oven and make setting changes at any time.

## Control and Time Settings

**Table 2: Minimum and maximum control settings: upper oven**

Feature	Minimum Temp	Maximum Temp
Rapid Preheat	170°F (76°C)	550°F (288°C)
Bake	170°F (76°C)	550°F (288°C)
Broil	300°F (148°C)	550°F (288°C)
Conv Bake	170°F (76°C)	550°F (288°C)
Conv Roast	170°F (76°C)	550°F (288°C)
Conv Broil	300°F (148°C)	550°F (288°C)
Keep Warm	150°F (66°C)	190°F (86°C)
Slow Cook	Lo 225°F (108°C)	Hi 275°F (134°C)
Bread Proof	85°F (30°C)	100°F (38°C)
Dehydrate	100°F (38°C)	225°F (108°C)
PerfectTurkey	170°F (76°C)	550°F (288°C)

**Table 3: Minimum and maximum time setting**

Feature	Minimum Time	Maximum Time
Timer 1	1 min	11 hr 59 min
Timer 2	1 min	11 hr 59 min
Clock 12 hour	1:00 hr	11 hr 59 min
Clock 24 hour	0:00 hr	23 hr 59 min
Cook time 12 hour	1 min	11 hr 59 min
Cook time 24 hour	1 min	23 hr 59 min
End time 12 hour	1:00 hr	12 hr 59 min
End time 24 hour	0:00 hr	23 hr 59 min
Clean Duration	Lite (2 hr)	Heavy (4 hr)

## Wave-Touch™ Display Modes

Your control is in a sleep mode when not in use. Only the clock time will display during this mode.

**To go to the Awake mode:**

To awaken the control, touch within the display panel (Figure 22). If the control panel is not touched again within 2 minutes, the control will return to the sleep mode. To start cooking you must select either the upper oven or the lower oven. User preferences are available during the awake mode as well as timers, oven light and the control lock.

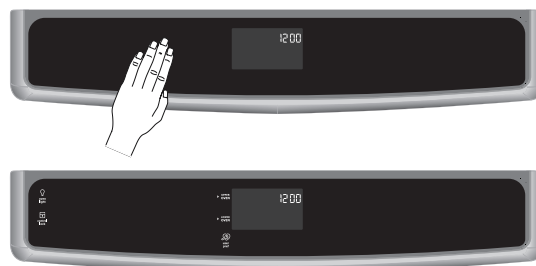

**Figure 22: Activating the awake mode**

## SETTING THE USER PREFERENCES

The User Preferences menu includes all user defined options. This feature enables you to control the various options of the electronic controls. This menu features the Time of Day, Celsius or Fahrenheit display mode, Continuous Bake or 12 Hour Energy Saving modes, Clock display or No-Clock display, 12 Hours Time of Day or 24 Hours Time of Day, Audio Control, and Adjusting the oven temperature. The User Preferences menu is only available when the oven is not on.

**To browse through the User Preferences menu:**

- To bring up the User Preferences menu, press **user pref**.
- Press **user pref** again to browse through the menu pages and select the feature you wish to adjust.
- Press **+hi** or **-lo** to toggle through a feature's available choices, which can include the ability to increase or decrease the numeric values. You may also use the numeric keypad to input precise values.
- Press **START enter** to accept a new option entry or press **user pref** to advance to the next preference.
- Press **CANCEL off** to save your entries and exit the user preferences mode.



### Setting the Clock-Time of Day

When the appliance is powered up for the first time or when the electric supply to the appliance has been interrupted, the display will flash **12:00** (Figure 23). Before any function of the oven can be set, **CANCEL off** must be pressed. This will set the clock at 12:00. To set the clock for the actual time the **user pref** key must first be pressed to bring the oven to the clock mode. Be sure to set the correct time on the clock before using the oven, especially if cooking with added time instructions.



Figure 23: 12:00 initial display

To set the clock time (example: 1:30):

1. Press **user pref**. **CLO 1200** appears in the display.
2. Enter **1 3 0** using the numeric keypad.
3. Press **START enter** to accept the new time.
4. Press **CANCEL off** to exit the user preferences menu.



**i** The clock cannot be adjusted while the oven is cooking, the timer is active, or during a self clean cycle.

**i** If an invalid time is entered, the control sounds an error tone, a chime. Re-enter a valid time and press **START enter**. Pressing **CANCEL off** automatically sets for **12:00**.

### Setting the Clock Display-On or Off

The clock display mode allows you to turn the clock display on or off.

To set the clock display:

1. Press **user pref** until **preset clock display** mode appears (Figure 24).
2. Use **+hi** or **-lo** to toggle to the **CLO off** option.
3. Press **START enter** to accept, then **CANCEL off** to exit the preferences mode.



Figure 24: Clock on (L) or off (R) display

**i** User preference options are not available while using any cooking function, when using the kitchen timer, or during self clean.

### Setting 12 or 24 Hour Display Mode

The oven control is factory preset to display the time of day in the 12-hour clock setting. The display can be changed to a 24 hour clock setting or to the OFF mode.

When the clock display is turned off, it continues to run and will function based on the previously set 12 or 24-hour setting.

To change clock display modes:

1. Press **user pref** until the preset **12hr clock display** mode appears (Figure 25).
1. Use **+hi** or **-lo** to toggle to the **24hr** option.
2. Press **START enter** to accept, then **CANCEL off** to exit the preferences mode.



Figure 25: Clock 12 hour (L) or 24 hour (R) display

**i** You cannot change the clock display mode while the oven is active with any cooking function or during self clean.

## Changing Oven Temperature Display-Fahrenheit (°F) or Celsius (°C)

The oven control can be programmed to display temperatures in °F or °C. The oven has been preset at the factory to display in °F

### To change the temperature display mode:

1. Press **user pref** key until **F-C F** appears in display (Figure 26).
2. Use **+hi** or **-lo** to toggle between the **F** or **C** option.
3. Press **START enter** to accept.
4. Press **CANCEL off** to exit the preferences mode.



Figure 26: F or C selection



You cannot modify the oven temperature display while oven is active with any cooking function or during self clean operation.

## Changing Between 12-Hour Energy Saving or Continuous Bake Mode Settings

The oven control is factory preset for a 12-hour Energy Saving mode. This setting automatically turns off any oven function after 11 hours and 59 minutes of non-stop cooking. The control may be set to override this feature if there is a need for cooking beyond 12 hours.

### To change between 12 Hour Energy Saving and continuous bake settings:

1. Press **user pref** until **ES on** or **ES off** appear in the display.
2. Press **+hi** or **-lo** again to toggle between **ES on** or **ES off**.
3. Press **START enter** to accept the desired setting, then **CANCEL off** to exit the preferences mode.



## Setting Silent or Audible Control Mode

The audio control feature allows you to control the audio volume for the oven control. You may turn the audio off and later return to operating with all the normal audible sounds and alerts. A tone sounds when a key is pressed and also at the end of a cycle (timer, cook time, or end time).

The factory audio setting is preset to level 5 (Figure 27). The volume can be adjusted for lower levels from 5 through 1, or it can be turned off for a silent control setting (Figure 27).

### To adjust the audio tone level:

1. Press **user pref** until **AUD 5** appears (Figure 27).
2. Use **+hi** or **-lo** to toggle from **5** down to **1**, or to the **off** option for desired level.
3. Press **START enter** to accept the new audio level, then press **CANCEL off** to exit the preferences mode.



Figure 27: Audio level adjust on (L) or off (R)



When the control is set for AUD off, error tones will remain audible.

## Oven/Control Lock

The control lock feature automatically locks the oven door and the control panel. The Control Lock is only allowed when the oven is in the awake mode. The door lock icon will flash in the display for 20 seconds or until the door has finished locking. Do not attempt to open the oven door while the door lock icon is flashing.

### To activate control lock:

- Press and hold **control lock** for three seconds. The time of day will be visible.



### To cancel the control lock feature:

- Press and hold **control lock** for three seconds. Once unlocked, the door lock icon will no longer appear.



If **OVEN** is pressed when oven lock is active, the oven will sound an error tone (a chime) indicating the function is not available until the control lock feature is turned off.

## Timers

This unit is equipped with two kitchen timers which serves as extra timers in the kitchen that will chime when the set time has run out. These timers can help timed cooking or food preparation times without interfering with any active cooking process. They do not start or stop cooking. When the time countdown reaches less than 1 minute, the display will show the time remaining in seconds. The timer feature can be used during any of the other oven control functions and cooking modes.

### To set the timer for 5 minutes:

1. Press **timer on-off**. **0:00** will appear in the display.
2. Press 5 on the numeric keypad to set the timer to 5 minutes. The **lo** or **hi** keys may be pressed to raise or lower the actual time displayed.
3. Press **timer on-off** again to accept and start the countdown.
4. When the set time runs out, **0:00** will be displayed, and **timer on-off** will flash. The clock will sound a chime that will be repeated at regular intervals until **timer on-off** is pressed.



### To cancel the timer before the set time has run out:

- Press **timer on-off**. The display will return to the time of day.



## Temperature Visual Display

Your oven is equipped with a temperature visual display for each oven. When a cooking mode is set, the actual temperature will display in the user interface window and will rise as the unit preheats. When the unit reaches the set temperature, a chime will sound to remind you to place the food in the oven. This feature is active with bake, convection bake, and convection roast.



The lowest temperature that will display is 100°F (38°C).

## Interior Oven Lights

Your appliance is equipped with "theater" style oven lighting feature that gradually lights the oven interiors to full brightness. The oven lights will turn on automatically when the oven door is opened. In addition, the oven lights will turn on in both ovens at the same time.

### The Two Dual Left/Right Corner Oven Lights

The interior oven lights are located at the rear of the oven cavity and are covered with a glass shield. The glass shield must be in place whenever the oven is in use.

**IMPORTANT!** For best results, keep the oven light turned OFF during bake. Remember to turn the light OFF after checking food.

### To toggle the oven lights on and off:

- Press **oven light**.



## RAPID PREHEAT

The rapid preheat feature can be set using the following oven modes: bake and convection bake. When activated, the oven will begin preheating quickly and **PRE-HEATING** will appear in the display. The minimum temperature shown is 170°F (76°C). A tone will sound to indicate the oven has finished preheating and **PRE-HEATING** will disappear from the display. Once the oven has fully preheated, the rapid preheat feature will perform like bake and continue to bake until cancelled.

**IMPORTANT!** The rapid preheat feature is for single rack only, and it is available only in the upper oven. The heat distribution with multiple rack will be uneven. Use a rack in position 2 or 3.

**IMPORTANT!** For batter- and dough-based baked goods such as cakes, pastries, and breads, use either the standard bake or convection bake function.

To set rapid preheat using the default oven temperature:

### ⚠ CAUTION

Always use pot holders or oven mitts when working with a hot oven. When baking, the oven interior and oven racks will become hot enough to cause burns.

1. Select **UPPER OVEN** to light up the available cooking modes keys.
2. Press **bake** or **conv bake**.
3. Press **cook options**.
4. Press **rapid preheat**.
5. Press **START enter**.



Rapid preheating is not suggested for roasting or casseroles.



The convection fan will rotate when the rapid preheat is started. This is normal. If rapid preheat is set with the bake feature the convection fan will turn off once the oven set temperature is reached.



To change temperature settings after rapid preheat has started, select the **UPPER** oven. Then, press the **+hi** or **-lo** keys to increase or decrease the oven temperature. The oven temperature will change by 5° (F) with each press of **+hi** or **-lo**. If changing cooking times, select the **cook time** or **end time** keys needed to make the changes.

To set rapid preheat with an oven temperature of 425°F (218°C):

### ⚠ CAUTION

Always use pot holders or oven mitts when working with a hot oven. When baking, the oven interior and oven racks will become hot enough to cause burns.

1. Select **UPPER OVEN** to light up the available cooking modes keys.
2. Press **bake** or **conv bake**.
3. Enter **4 2 5** using the numeric keypad.
4. Press **cook options**.
5. Press **rapid preheat**.
6. Press **START enter**.



**425**



To stop rapid preheat at any time, press **CANCEL off**.

## BAKE

Bake may be set with these options: 1) rapid preheat; 2) cook time; 3) end time; and 4) meat probe, achieved through using the cook time and end time settings.

### To set the oven for bake at the default oven temperature of 350°F (176°C):

#### CAUTION

Always use pot holders or oven mitts when working with a hot oven. When baking, the oven interior and oven racks will become hot enough to cause burns.

#### CAUTION

Do not bake foods directly on the oven bottom. To avoid damaging the oven interior and surfaces, always bake foods in the oven using bakeware positioned on an oven rack.

1. Place food in the oven.
2. Select an oven by pressing either **UPPER OVEN** or **LOWER OVEN** to light up the available cooking modes keys.

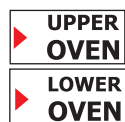

3. Press **bake**. The default oven temperature of 350°F (176°C) appears in the display.



4. Press **START enter**.
5. When Bake is active the oven begins to preheat. Display will show **PRE-HEATING** and the convection fan will run until preheating is done. (The convection element only shows for upper oven during preheat.) When the oven reaches the set temp, the control sounds a tone to signal oven is ready.



6. To stop bake at any time, press **CANCEL off**.

### To set bake with oven temperature of 425°F(218°C):

1. Select an oven by pressing either **UPPER OVEN** or **LOWER OVEN** to light up the available cooking modes keys.

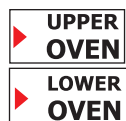

2. Press **bake**.



3. Enter **4 2 5** using the numeric keypad.

bake  
**425**

4. Press **START enter**. To add or change any bake settings once the oven is baking, make temperature changes using the **+hi** or **-lo** keys. Each press will adjust the temp by ±5°F (±2°C).



5. To stop bake at any time, press **CANCEL off**.



The convection fan will rotate when bake first starts. This is normal. The fan will turn off once the oven reaches the set temperature.



If bake is active without a cook time setting, the oven will remain on for 12 hours before turning off automatically unless it is cancelled. To bake longer than 12 hours, see [“Changing Between 12-Hour Energy Saving or Continuous Bake Mode Settings”](#) on page 20 for instructions.

#### Baking Tips

- Fully preheat the oven before baking items like cookies, cakes, biscuits, or breads.
- When using a single rack for baking, position the rack so that the food is in the center of the oven.
- For best results when baking cakes or cookies using two oven racks, use the convection bake function. If using two racks, place bakeware on oven rack in positions 1 and 4 (Figure 28) and place pans as shown in Figure 29. Use glide rack in position 1 and a flat rack in position 4.
- Allow at least 2 inches (5 cm) of space between bakeware for proper air circulation.
- Dark or dull pans and glass absorb more heat than shiny bakeware resulting in dark or over browning of foods. To prevent this it may be necessary to reduce the oven temperature or cook time to prevent over browning of some foods. Dark pans are recommended for pies. Shiny pans are recommended for cakes, cookies and muffins.
- Do not open the oven door too often. Opening the door will reduce the temperature in the oven.
- For cakes, pastries, and breads, use the convection bake function for best results when using multiple racks.

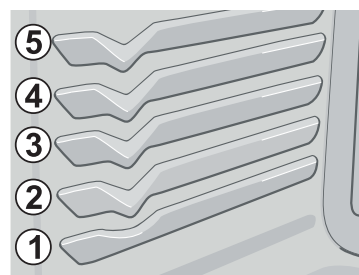

Figure 28: Rack positions

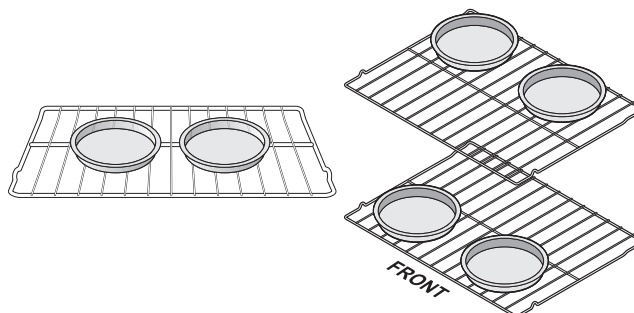

Figure 29: Single rack pan spacing (L), Double spacing (R)

## Cook Time

Cook time is used when a recipe calls for a specific temperature and cook time. It allows the oven to be set to cook for a set length of time and shut off automatically. The maximum cook time is 11 hours, 59 minutes. This feature can be used with bake, convection bake, convection roast, keep warm, defrost, bread proof, and dehydrate. It can also be part of a multi stage sequence.

**To bake for 30 minutes with the oven at default temperature setting of 350°F (176°C):**

### WARNING

Food Poisoning Hazard. Do not let food sit for more than one hour before or after cooking. Doing so can result in food poisoning or sickness. Foods that can easily spoil such as milk, eggs, fish, meat, or poultry should be chilled in the refrigerator first. Even when chilled, they should not stand in the oven for more than 1 hour before cooking begins and should be removed promptly when finished cooking. Eating spoiled food can result in sickness from food poisoning.

### CAUTION

Use the automatic timer when cooking cured or frozen meats and most fruits and vegetables.

1. Select an oven by pressing either **UPPER OVEN** or **LOWER OVEN** to light up the available cooking modes keys.
2. Press **bake**.
3. Press **cook options**.
4. Press **cook time**.
5. Enter **30** using the numeric keypad.
6. Press **START enter**. The oven starts heating. Cook time will start counting down for the set time.
7. **End** will appear in the display window and the oven will shut off automatically when the time runs out. The control will chime and repeat the end tones every 10-15 seconds until **CANCEL off** is pressed. To stop cooking, press **CANCEL off**.

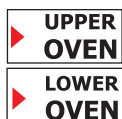

bake



cook options



cook time

30



START enter



CANCEL off



To change a cook time during cooking, press **cook time**, use **lo** or **hi** to adjust the time, and press **START enter** to finish.

## Setting Cook Time with End Time

End time allows the oven to be set to shut off automatically at a set time of day. The oven control will calculate the remaining time by itself. The oven will shut off and chime when the count-down is finished. This feature can be used with bake, convection bake, convection roast, slow cook, keep warm, defrost, dehydrate, and bread proof. This oven can be programmed with cook time and end time to start and stop by itself at the right time. Before setting end time, be sure the time of day is set correctly on the oven clock.

**To set the oven to bake at 375°F (191°C) for 50 minutes and to automatically shut off at 5:30:**

1. Select an oven by pressing either **UPPER OVEN** or **LOWER OVEN** to light up the available cooking modes keys.
2. Press **bake**.
3. Enter **375** using the numeric keypad.
4. Select **cook options**.
5. Press **cook time**.
6. Enter **50** using the numeric keypad.
7. Press **end time**.
8. Enter **530** using the numeric keypad.
9. Press **START enter**.
10. **End** will appear in the display window and the oven will shut off automatically when the time runs out. The control will chime and repeat the end tones every 10-15 seconds until **CANCEL off** is pressed. To stop cooking, press **CANCEL off**.



bake

375



cook options



cook time

50



end time

530



START enter



CANCEL off

Once **START enter** is pressed, the oven will calculate the delayed start time. When the oven reaches the delayed starting time, the oven will automatically turn on and heat to the set temperature. The oven will maintain the set temperature throughout the set cook time until the set end time cancels the cooking function.

To change temperature settings during the cooking process, use the **+hi** or **-lo** keys to increase or decrease the oven temperature. The oven temperature will change by 5° (F) with each press of the **+hi** or **-lo** key.



## BROIL

Broiling is a method of cooking tender cuts of meat by direct heat under the broil element of the oven. This mode is best for meats, fish, and poultry up to 1" thick. The meat probe cannot be used with this mode. Depending on cooking preferences, you can increase or decrease cooking times or move food to a different rack position. If the food you are broiling is not listed in [Table 4](#), follow the instructions provided in your cookbook and watch the item closely.

**To broil with default broil oven temperature of 550°F (288°C):**

1. Arrange interior oven racks and place the broiler insert on the broiler pan, then place the meat on the insert ([Figure 30](#)). Be sure to close the oven door.
2. Select **UPPER OVEN** to light up the available cooking modes keys.
3. Press **broil**. The display will show **5 5 0**.
4. Press **START enter**. To change temperature settings, use the **+hi** or **-lo** keys to increase or decrease the oven temperature. The oven temperature will change by 5°F with each press of **+hi** or **-lo**.
5. Place food in the oven after preheating for 2 minutes to rack position recommendations ([Table 4](#)) and ([Figure 31](#)). Be sure to place pan with the meat directly under the broil element and close the oven door during broiling.
6. Turn food when the top side is browned and cook on the second side.
7. Press **CANCEL off** to stop the broil feature.



### ⚠ WARNING

If an oven fire occurs, turn the oven off and do not open the door. If the fire continues, throw baking soda on the fire or use a fire extinguisher. Do not put water or flour on the fire. Flour may be explosive, and water can cause a grease fire to spread and possibly cause personal injury.

### ⚠ CAUTION

Always use pot holders or oven mitts when using a hot oven. When broiling, the oven interior and oven racks will become hot enough to cause burns. Do not use the broiler pan without the insert. Do not cover the broil pan or insert with aluminum foil; the exposed grease could ignite.

### Important notes:

- Always arrange oven racks when the oven is cool. For optimum browning, preheat the broil element for five to six minutes before placing meat in the oven. To avoid burning food, watch the food carefully when broiling and turn meat when needed.
- Broiler pans and inserts allow the grease to drain away from the high heat of the broiler. Do not use the pan without the insert. Do not cover the broiler insert with aluminum foil—the exposed grease could ignite.

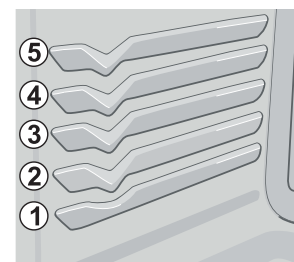
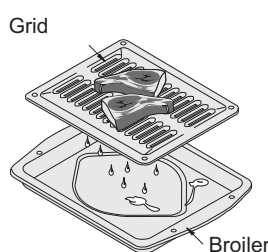

Figure 30: Broiler pan/insert

Figure 31: Rack positions

Table 4: Broiling recommendations<sup>1), 2), 3)</sup>

Food Item	Rack Position	Temperature	Cook Time (in minutes)		Internal Temp	Doneness
			1st side	2nd side		
Steak 1" thick	5th	550°F (288°C)	5	4	135°F (57°C)	Rare
Steak 1" thick	5th	550°F (288°C)	6	5	145°F (63°C)	Medium
Steak 1" thick	5th	550°F (288°C)	8	7	170°F (77°C)	Well
Pork Chops 3/4" thick	5th	550°F (288°C)	8	6	170°F (77°C)	Well
Chicken - Bone In	3rd	450°F (232°C)	20	10	170°F (77°C)	Well
Chicken - Boneless	5th	450°F (232°C)	8	6	170°F (77°C)	Well
Fish	5th	500°F (288°C)	13	n/a	170°F (77°C)	Well
Shrimp	3rd	550°F (288°C)	5	n/a	170°F (77°C)	Well
Hamburger 1" thick	5th	550°F (288°C)	5	4	135°F (57°C)	Rare
Hamburger 1" thick	5th	550°F (288°C)	6	5	145°F (63°C)	Medium
Hamburger 1" thick	3rd	550°F (288°C)	10	8	170°F (77°C)	Well

- 1) Broiling is direct heat cooking and will produce some smoke. If smoke is excessive, place food further away from the element. Always watch food carefully to prevent burning.
- 2) The U.S. Department of Agriculture states, "Rare fresh beef is popular, but you should know that cooking it to only 140°F (60°C) means some food poisoning organisms may survive." (Source: Safe Food Book, Your Kitchen Guide, USDA Rev. June 1985.) The lowest temperature recommended by the USDA is 145°F (63°C) for medium rare fresh beef. For beef medium 160°F, well done 170°F.
- 3) Use the off-set or half-rack (if available) only in the top position.

## CONVECTION BAKE

Convection functions use a fan to circulate the oven's heat uniformly and continuously around the oven (Figure 32). This improved heat distribution allows for fast, even baking and browning results. It also gives better baking results when using two oven racks at the same time. Heated air flows around the food from all sides, sealing in juices and flavors. Breads and pastry brown more evenly. Most foods baked in a standard pan will bake faster and more evenly with the convection feature. Multiple rack baking may slightly increase bake time for some foods, but the overall result is time saved.



Rack positions are 1 (glide rack) and 4 (flat rack). The convection bake feature is best used for multiple rack baking. Use this feature when the recipe instructions have been written especially for convection baking. If the recipe instructions are for baking and you wish to use convection baking, follow the "Convection Convert" instructions on page 27. Convection convert will automatically adjust the oven temperature so that convection baking will provide the best possible results.

### Benefits of convection bake:

- Superior multiple oven rack performance
- Foods bake more evenly
- No special pans or bakeware required
- Foods can bake up to 25 to 30% faster.

### Convection bake may be set with the following options:

- Convection convert
- Rapid preheat
- Meat probe
- Cook time or cook time with end time settings

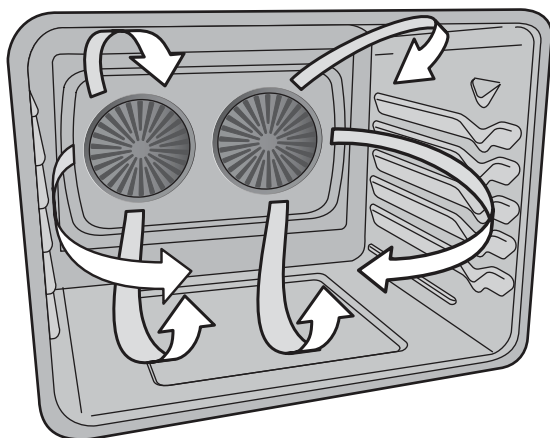

Figure 32: Air circulation in convection mode

To set convection bake with the factory default temperature of 350°F (176°C):

### ⚠ CAUTION

Always use pot holders or oven mitts when working with a hot oven. When baking, the oven interior and oven racks will become hot enough to cause burns.

1. Arrange interior oven racks.
2. Press **UPPER OVEN** to light up the available cooking modes keys.



3. Press **conv bake**.



4. Press **START enter**. The display will show **PRE-HEATING**.



5. Place food in the oven when the chime signals, the temperature display shows that the oven has reached the set target temperature, and **PRE-HEATING** disappears. Remove food once complete.

6. Press **CANCEL off** to stop or cancel the convection bake feature at any time.



**IMPORTANT!** If the oven door is opened when convection bake is active, the convection fans will stop rotating until the oven door is closed.



When using convection bake, bake time reductions may vary depending on the amount and type of food being baked.

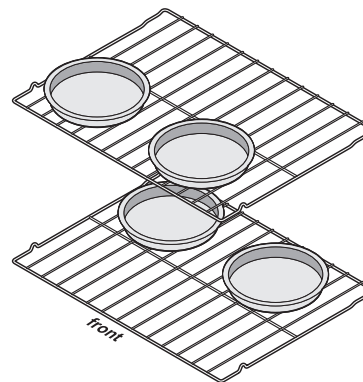

Figure 33: Pan spacing for convection baking

### Convection Baking/Convert Tips

- Fully preheat the oven before baking items like cookies, biscuits, and breads.
- When using any single oven rack, use the radiant bake function and position the rack in the oven so that the food is in the center of the oven.
- When baking cakes using two oven racks, place bakeware in positions 1 and 4 (Figure 34) and place pans as shown in Figure 33. Use a flat rack in position 4 and a glide rack in position 1.
- Allow 2 inches (5 cm) of space between bakeware to allow for proper air circulation.
- Cookies and biscuits should be baked on pans with no sides or very low sides to allow air to circulate around the food.
- Dark or dull bakeware absorbs more heat than shiny bakeware, resulting in dark or overbrowned foods. It may be necessary to reduce oven temperature or bake time to prevent overbrowning of some foods. Dark bakeware is recommended for pies. Shiny bakeware is recommended for cakes, cookies, and muffins.
- Do not open the oven door often. Opening the door will reduce the temperature in the oven and may increase bake time.
- Reduce oven temperature 25°F (14°C) from recipe's recommended oven temperature. Follow the remainder of the recipe's instructions using the minimum recommended bake time.
- For cakes, pastries, and breads, use the convection bake function for best results when using multiple racks.

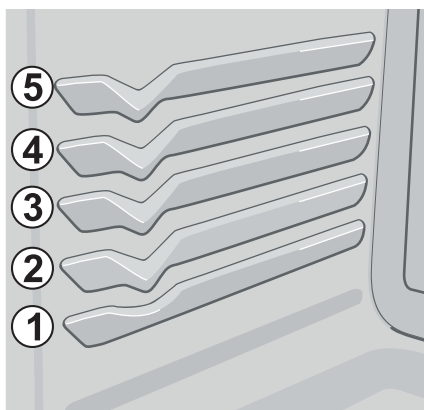

Figure 34: Rack positions

### Convection Convert

Use convection convert to automatically convert any normal baking recipe into a convection bake recipe. The control uses the normal recipe settings and adjusts to a lower temperature for convection baking. When set properly, this feature is designed to display the actual converted (reduced) temperature in the display. Convection convert can only be used with convection bake. Convection convert can be set with cook or end time instructions.

#### Benefits of convection convert:

- Superior multiple oven rack performance
- Some foods bake faster, saving time and energy
- No special bakeware required



When using convection convert, bake time reductions may vary depending on the open temperature setting. Convection convert reduces original temperatures by 25°F (14°C).

#### To set convection convert with the factory default oven temperature of 350°F (176°C):

#### ⚠ CAUTION

Always use pot holders or oven mitts when using the oven. When baking, the oven interior and oven racks will become very hot which can cause burns.

1. Arrange interior oven racks.
2. Press **UPPER OVEN** to light up the available cooking modes keys.
3. Press **conv bake**.
4. Press **cook options**. The bake options keys will light up.
5. Press **conv convert**. The temperature displayed will be 25°F (14°C) lower than what it used to be.
6. Press **START enter** to begin the convection baking. Once the oven reaches the set temperature, a tone will sound indicating the oven is ready.
7. Press **CANCEL off** to stop or cancel the convection feature at any time.



Convection convert can be set after the convection bake function is started by pressing **cook options**, and then pressing **conv convert**.









### Using Convection convert with cook time

When convection conversion is used with the cook time feature, **CF** (check food) will be displayed when 75% of the bake time is complete. The control will chime at regular intervals until **CANCEL off** is pressed, as a reminder to check the food. When the cook time runs out, the oven will shut off automatically and chime.

#### To set convection convert for 30 minutes at 375°F (191°C):

##### CAUTION

Always use pot holders or oven mitts when using the oven. When baking, the oven interior and oven racks will become very hot which can cause burns.

1. Arrange interior oven racks.
2. Press **UPPER OVEN** to light up the available cooking modes keys. 
3. Press **conv bake**.   
conv  
bake
4. Enter **3 7 5** using the numeric keypad.   
375
5. Press **cook options**. The bake options keys will light up.   
cook  
options
6. Press **cook time**.   
cook  
time
7. Enter **3 0** using the numeric keypad.   
30
8. Press **conv convert**. The temperature displayed will be 25°F (14°C) lower than what it used to be.   
conv  
convert
9. Press **START enter** to begin the convection baking. Once the oven reaches the set temperature, a tone will sound indicating the oven is ready.   
START  
enter
10. Press **CANCEL off** to stop or cancel the convection feature at any time.   
CANCEL  
off



The convection convert feature will work best if the bake time is 20 minutes or longer. If setting a bake time that is under 20 minutes, the feature will not chime at 75% of the bake time.

## Convection Roast

Convection roast is best for cooking tender cuts of beef, lamb, pork, and poultry. Heated air circulates around the meat from all sides, gently browning the exterior and sealing in the juices and flavors. Use this mode when cooking speed is desired. Convection roast uses the hidden bake element, the hidden convection element, the broil element, and a fan to circulate the oven's heat evenly and continuously within the oven.

Convection roast may be set with cook time, cook time with end time and probe. Preheating is not necessary when using convection roast.

### To set convection roast with the default oven temperature of 350°F (176°C):

1. Arrange interior oven racks.
2. Press **UPPER OVEN** to light up the available cooking modes keys.
3. Press **conv roast**.
4. Press **START enter**. To change temperature settings after this feature has started, press **+hi** or **-lo** to increase or decrease the oven temperature. The oven temperature will change by  $\pm 5^{\circ}\text{F}$  ( $\pm 2^{\circ}\text{C}$ ) with each press of **+hi** or **-lo**.
5. Press **CANCEL off** to stop or cancel the convection feature at any time.



### To properly arrange food for roasting:

#### ⚠ CAUTION

Always use pot holders or oven mitts when using the oven. When cooking, the oven interior and oven racks will become very hot which can cause burns. Do not cover the broil pan/insert with aluminum foil; the exposed grease could ignite.

#### ⚠ WARNING

Should an oven fire occur, close the oven door and turn the oven off. If the fire continues, throw baking soda on the fire or use a fire extinguisher. Do not put water or flour on fire. Flour may be explosive, and water can cause a grease fire to spread and cause personal injury.

1. Place the oven rack on bottom or next to the bottom oven rack position.
2. Place the insert/grid on the broiler pan. Make sure the insert is securely seated on top of the broiler pan. Do not use the broiler pan without the insert. Do not cover the insert with aluminum foil.
3. Next, place the roasting rack on the insert/grid. Make sure the roasting rack is securely seated on the grid in the broiler pan. The roasting rack allows the heated air to circulate under the food for even cooking and helps to increase browning on the underside.
4. Place meat (fat side up) on insert (Figure 35). Place prepared food on oven rack and slide into oven.

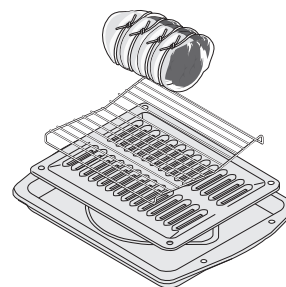

Figure 35: Broil pan, insert, and roasting rack

Table 5: Convection roasting temperature and time recommendations

Meat		Weight	Oven Temp	Internal Temp	Minutes per lb.
Beef	Standing rib roast <sup>1)</sup>	4 to 6 lbs.	350°F (177°C)	160°F (71°C) <sup>1)</sup>	25-30
	Ribeye roast <sup>1)</sup>	4 to 6 lbs.	350°F (177°C)	160°F (71°C) <sup>1)</sup>	25-30
	Tenderloin roast <sup>1)</sup>	2 to 3 lbs.	400°F (204°C)	160°F (71°C) <sup>1)</sup>	15-25
Poultry	Turkey whole <sup>2)</sup>	12 to 16 lbs.	325°F (163°C)	180°F (82°C)	8-10
	Turkey whole <sup>2)</sup>	16 to 20 lbs.	325°F (163°C)	180°F (82°C)	10-15
	Turkey whole <sup>2)</sup>	20 to 24 lbs.	325°F (163°C)	180°F (82°C)	12-16
	Chicken	3 to 4 lbs.	350°F-375°F (177°C-191°F)	180°F (82°C)	12-16
Pork	Ham roast, fresh	4 to 6 lbs.	325°F (163°C)	160°F (71°C)	30-40
	Shoulder blade roast	4 to 6 lbs.	325°F (163°C)	160°F (71°C)	20-30
	Loin	3 to 4 lbs.	325°F (163°C)	160°F (71°C)	20-25
	Pre-cooked ham	5 to 7 lbs.	325°F (163°C)	160°F (71°C)	30-40

1) For beef, medium 160°F. Well done 170°F.

2) Stuffed turkey requires additional roasting time. Shield legs and breast with foil to prevent over browning and drying of the skin.

### Convection Roasting tips:

- Preheating for convection roast will not be necessary for most meats and poultry.
- Arrange oven racks so the food is in the center of the oven.
- Since convection roast cooks faster, you can reduce cook times by 25% from the recommended time of your recipe (check the food at this time). Then if needed, increase cook time until the desired doneness is obtained.
- Do not cover foods when dry roasting - covering will prevent the meat from browning properly.
- Be sure to carefully follow your recipe's temperature and time recommendations or refer to the convection roast recommendations in [Table 5](#).
- Use the broiler pan and insert, as well as the roasting rack ([Figure 35](#)) (some models). The broiler pan will catch grease spills, and the insert will help prevent splatters. The roasting rack will hold the meat.
- Do not use the broiler pan without the grid or cover the grid with aluminum foil.
- Always pull the rack out to the stop position before removing food.
- It is not recommended to roast chicken on a roasting rack. Use a deep pan instead.

### Convection Broil

Use convection broil to cook thicker cuts of meat, fish, and poultry that require direct exposure to radiant heat and the convection fan for optimum browning results. Convection broil gently browns the exterior and seals in the juices. It uses the broil element and a fan to circulate the oven's heat evenly and continuously within the oven.

The convection fan will begin rotating once convection broil has been activated, and the oven door is closed.

#### Convection Broiling Tips:

- Always pull the rack out to the stop position before turning or removing food.
- For optimum browning, preheat the broil element for 2 minutes and broil with the door closed.
- Broil one side until the food is browned; turn and cook on the second side. Season and serve.
- Always use the broiler pan and its insert when broiling, if included. It allows the dripping grease to be kept away from the high heat of the broil element ([Figure 35](#)).
- Do not use the broil pan without the insert. Do not cover the broil pan insert with foil. The exposed grease could catch fire. Do not use the roasting rack when broiling.
- Since convection broil cooks food quickly, reduce the cook time by 25% from the recommended cook time of your recipe (check the food at this time). If necessary, increase cook time until the desired doneness is obtained.

To set convection broil with a default oven set temperature of 550°F (288°C):

#### ⚠ CAUTION

Always use pot holders or oven mitts when using the oven. When cooking, the oven interior and oven racks will become very hot which can cause burns. Do not cover the broil pan/insert with aluminum foil; the exposed grease could ignite.

#### ⚠ WARNING

Should an oven fire occur, close the oven door and turn the oven off. If the fire continues, throw baking soda on the fire or use a fire extinguisher. Do not put water or flour on fire. Flour may be explosive, and water can cause a grease fire to spread and cause personal injury.

1. Arrange interior oven racks.
2. Press **UPPER OVEN** to light up the available cooking modes keys.
3. Press **conv broil**.
4. Press **START enter**. The convection fan will begin rotating once convection broil has been activated and oven door is closed. To change temperature settings, press **+hi** or **-lo** to increase or decrease the oven temperature. The oven temperature will change by  $\pm 5^{\circ}\text{F}$  ( $\pm 2^{\circ}\text{C}$ ) with each press of **+hi** or **-lo**.
5. Press **CANCEL off** to stop or cancel the convection feature at any time.

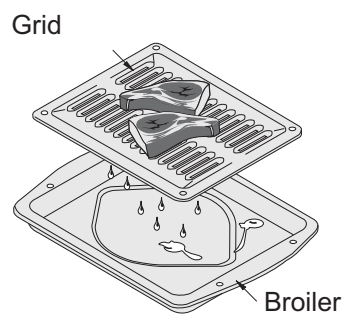

**Figure 36: Broil pan and grid**



The meat probe cannot be used in this cooking mode.

## Keep Warm

Keep warm is best for keeping oven baked foods warm for serving after cooking has finished. It may be set with cook time, cook time/end time, and multi stage. Keep warm uses the hidden bake element to maintain the temperature within the oven. Keep warm will run continuously or (if used with bake time) until the time runs out.

**To set a keep warm at the default of 170°F (76°C):**

### **WARNING**

Food Poisoning Hazard. Do not let food sit for more than one hour before or after cooking. Doing so can result in food poisoning or sickness. Foods that can easily spoil such as milk, eggs, fish, meat, or poultry should be chilled in the refrigerator first. Even when chilled, they should not stand in the oven for more than 1 hour before cooking begins and should be removed promptly when finished cooking. Eating spoiled food can result in sickness from food poisoning.

1. Arrange interior oven racks.
2. Select an oven by pressing either **UPPER OVEN** or **LOWER OVEN** to light up the available cooking modes keys.
3. Press **keep warm** to activate the keep warm function. The default temperature of 170°F (76°C) will appear in the display.
4. Press **START enter**.
5. Press **CANCEL off** to stop or cancel the keep warm feature.



**To set keep warm with a setting of 150°F (71°C):**

### **WARNING**

Food Poisoning Hazard. Do not let food sit for more than one hour before or after cooking. Doing so can result in food poisoning or sickness. Foods that can easily spoil such as milk, eggs, fish, meat, or poultry should be chilled in the refrigerator first. Even when chilled, they should not stand in the oven for more than 1 hour before cooking begins and should be removed promptly when finished cooking. Eating spoiled food can result in sickness from food poisoning.

1. Arrange interior oven racks.
2. Select an oven by pressing either **UPPER OVEN** or **LOWER OVEN** to light up the available cooking modes keys.
3. Press **keep warm** to activate the keep warm feature.



4. Press **-lo** until the temperature shows **150** on the display. **150**

5. Press **START enter**.



6. Press **CANCEL off** to stop or cancel the keep warm feature.



If changing cooking times, use cook time or end time to make the desired changes. Refer to **“Cook Time”** and **“Setting Cook Time with End Time”** on page 24 for instructions.

### Keep Warm Tips:

- Always start with hot food. Do not use the warm feature to heat cold food.
- Food in heat-safe glass and glass ceramic containers may need higher temperature settings compared to food in regular containers.
- Avoid repeated openings of the oven. It will allow hot air to escape and the food to cool.
- Aluminum foil may be used to cover food to increase moisture content.

### Keep Warm Temperature Selection

See **Table 6** for the recommended keep warm food settings. If a particular food is not listed, use the default temperature of 170°F (76°C). If more crispness is desired, remove the lid or aluminum foil from the food. Most foods can be kept as serving temperatures of 170°F (76°C). When a combination of foods are to be kept warm (for example, a meat with two vegetables and rolls) use 170°F (76°C).

**Table 6: Keep warm recommended food settings**

Food Item	Heating Level
Fried foods	hi 190°F (86°C)
Vegetables	med 170°F (76°C)
Soups (Cream) and Stews	med 170°F (76°C)
Sauces	med 170°F (76°C)
Meats	med 170°F (76°C)
Gravies	lo 150°F (66°C)
Eggs	lo 150°F (66°C)
Dinner plates with food	lo 150°F (66°C)
Casseroles	lo 150°F (66°C)
Breads and pastries	lo 150°F (66°C)

## MEAT PROBE

When cooking meat such as roasts, hams, or poultry, use the meat probe function to check the internal temperature without guesswork. For some foods, especially poultry and roasts, testing the internal temperature is the best method to ensure properly cooked meats. Your oven will automatically change from cooking to keep warm once the probe has reached the set temperature.

The following temperature settings apply to the probe function:

- Default: 170°F (76°C)
- Minimum: 130°F (54°C)
- Maximum: 210°F (98°C)

### IMPORTANT!

- Use only the meat probe supplied with appliance. Using any other probe or device may result in damage to appliance and the meat probe receptacle.
- Never leave or store meat probe inside oven.
- Defrost food completely before inserting meat probe to avoid damaging probe.

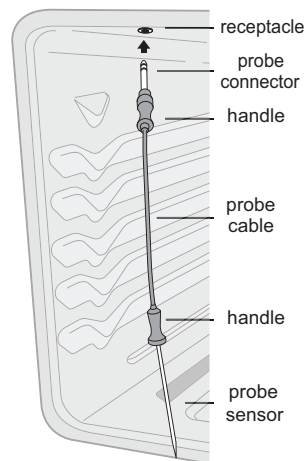
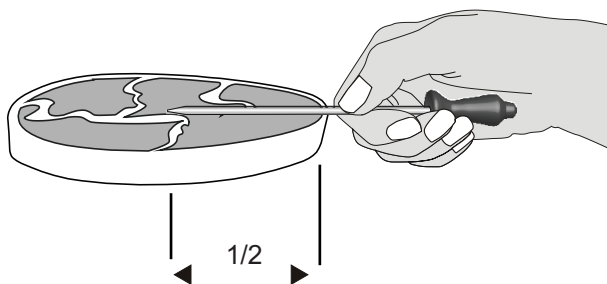

**Figure 37: Probe receptacle insertion**

The probe receptacle is located at the top of the oven cavity as shown in [Figure 37](#).

### Proper meat probe placement

Always insert meat probe so that the probe tip rests in the center of the thickest part of meat. Do not allow meat probe to touch bone, fat, gristle, or bakeware.



**Figure 38: Proper probe placement**

### Tips for Probe Placement

- For bone-in ham or lamb, insert meat probe into the center of lowest large muscle or joint.
- For meals such as meat loaf or casseroles, insert meat probe into center of food.
- When cooking fish, insert meat probe just above the gill.

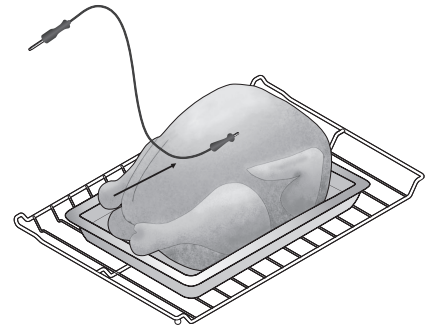

**Figure 39: Proper probe placement**



For whole poultry or turkey, insert meat probe into the thickest part of the breast ([Figure 39](#)).

### To set the meat probe:

Follow these steps to set the probe target temperature to 180°F (82°C) when using the convection roast feature with oven set temperature for 325°F (162°C): The default internal temperature when setting the probe is 170°F (76°C).

### ⚠ CAUTION

Always use pot holders or oven mitts when working with a hot oven. When baking, the oven interior and oven racks will become hot enough to cause burns.

### ⚠ CAUTION

Handle the meat probe carefully when inserting and removing from food or probe receptacle. Do not use kitchen utensils, such as tongs, to pull on meat probe cable when inserting or removing from food or receptacle. Use the provided handle, as shown in [Figure 37](#). To avoid possibility of burns after cooking, carefully unplug meat probe using a pot holder to protect hands.

1. Prepare the food and properly insert the meat probe into the food. Do not preheat or start cooking before properly inserting the meat probe. Probe should be inserted into the food and receptacle while the oven is still cool.
2. Place the prepared food on the desired oven rack position and slide into the oven.
3. Plug the meat probe into the probe receptacle located on the top of the oven cavity. When the meat probe is correctly plugged in to receptacle, the probe icon will illuminate in the oven control display after **cook options** is pressed.



- 4. Press **UPPER OVEN** to light up the available cooking modes keys.



- 5. Press **conv roast**.



- 6. Enter **3 2 5** using the numeric keypad.

**325**

- 7. Press **cook options**.



- 8. Press **probe**. The default temperature of 170°F appears in the display



- 9. Enter **1 8 0** using the numeric keypad to change the probe setting.

**180**

- 10. Press **START enter**.



- 11. During the cooking process, the actual meat probe temperature will display by default. To view the target temperature, press **probe** once. After 6 seconds the display will show the actual meat probe temperature. If the target temperature needs to be changed during the cooking process, press **probe** once and use the numeric keys to adjust the target temperature. Press **START enter** to accept any change.



- 12. The oven control will chime when the internal target temperature is reached. By default the oven will automatically change to a keep warm setting. Keep warm will maintain the oven temperature at 170°F (76°C).

- 13. Press **CANCEL off** to stop cooking at any time.



**Table 7: USDA recommended minimum internal cooking temps**

Food Type	Internal Temp.
<b>Ground meat and meat mixtures</b>	
Beef, Pork, Veal, Lamb	160°F (71°C)
Turkey, Chicken	165°F (74°C)
<b>Fresh beef, veal, lamb</b>	
Medium rare +	145°F (63°C)
Medium	160°F (71°C)
Well Done	170°F (77°C)
<b>Poultry</b>	
Chicken and Turkey, whole	165°F (74°C)
Poultry Breasts, Roasts	165°F (74°C)
Poultry Thighs, Wings	165°F (74°C)
Duck and Goose	165°F (74°C)
Stuffing (cooked alone or in bird)	165°F (74°C)
<b>Fresh pork-roasts, steaks, and chops</b>	
Medium	160°F (71°C)
Well Done	170°F (77°C)
<b>Ham</b>	
Fresh (raw)	160°F (71°C)
Pre-cooked (to reheat)	140°F (60°C)
<b>Eggs and egg dishes</b>	
Eggs	Cook til yolk/white firm
Eggs dishes	160°F (71°C)
Leftovers and Casseroles	165°F (74°C)

The U.S. Department of Agriculture states, "Rare fresh beef is popular, but you should know that cooking it to only 140°F (60°C) means some food poisoning organisms may survive." (Source: *Safe Food Book, Your Kitchen Guide*, USDA Rev. June 1985.) The lowest temperature recommended by the USDA is 145°F (63°C) for medium rare fresh beef. For beef medium 160°F, well done 170°F.

Visit the USDA Food Safety and Inspection web site at [www.fsis.usda.gov](http://www.fsis.usda.gov)

## Perfect Turkey™

Heated air circulates around the turkey from all sides, sealing in juices and flavors. Poultry cooked with this feature are crispy brown on the outside while staying moist on the inside.

Perfect turkey combines a cook cycle with the convection fan. The probe is used to monitor the exact internal temperature of the turkey while cooking. Once the turkey has reached the set temperature, the oven will stop cooking and change to keep warm.

Before setting the perfect turkey feature, or if you would like to change the probe target temperature, be sure to carefully read and follow setting the probe instructions.

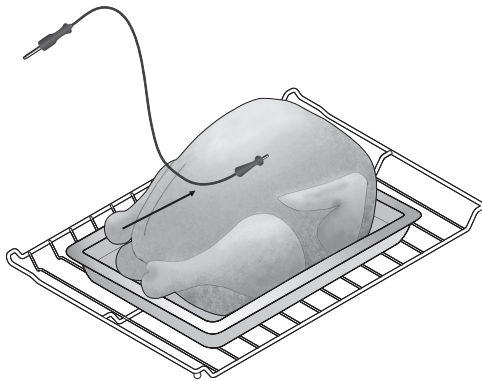

**Figure 40: Proper probe placement**

**IMPORTANT!** The temperature of the meat probe can be entered only when the probe is plugged in. If the probe is unplugged, the meat probe set temperature will be reset back to the default temperature of 180°F (82°C).

**IMPORTANT!** It is not recommended to modify the perfect turkey settings once cooking has started. Doing so may not provide the best results.

### Setting Perfect Turkey™

The default oven temperature of 325°F (163°C) is the optimal temperature for roasting turkey and cannot be changed. The probe ensures that the turkey will be cooked to the desired doneness.

#### To use the perfect turkey feature:

1. Insert the probe into the thickest part of the breast and place the turkey in the oven.
2. Plug the meat probe into the probe receptacle located on the top of the oven cavity (Figure 37).
3. Press **UPPER OVEN** to light up the available cooking modes keys.



4. Press **perfect turkey**. The meat probe set temperature will be 180°F (82°C) by default.



5. Press **START enter**.



It is not recommended to modify the perfect turkey settings once baking has started.

6. Press **CANCEL off** any time when setting the control or during the cooking process.



**Table 8: Perfect turkey temperature recommendations<sup>1)</sup>**

Meat	Weight	Oven Temp	Internal Temp	Min, per lb.
Turkey <sup>2)</sup>	12-16 lb.	325°F (163°C)	180°F (82°C)	8-10
Turkey <sup>2)</sup>	16-20 lb.	325°F (163°C)	180°F (82°C)	10-15
Turkey <sup>2)</sup>	20-24 lb.	325°F (163°C)	180°F (82°C)	12-16
Chicken	3-4 lbs	350°F-375°F (177°C-191°F)	180°F (82°C)	12-16

- 1) Stuffed turkey requires additional roasting time. Shield legs and breast with foil to prevent overbrowning and drying of the skin.
- 2) Weight, Oven temp, internal temp, and minutes per lb are for a whole turkey

## Setting Defrost

Only frozen foods that can be defrosted and served without cooking should be used with this feature. Use defrost to thaw small portions of delicate items such as cream cakes, frozen cream pies, and cheesecake at room temperature. While in the defrost mode, the convection fan will operate to circulate room temperature air around the food slowly, accelerating the natural defrosting of the food without using heat. Defrost may be set with cook time and cook time with end time.

**To set defrost:**

### CAUTION

Always use pot holders or oven mitts when working with a hot oven. When baking, the oven interior and oven racks will become hot enough to cause burns.

### CAUTION

This feature is not meant for thawing frozen meats, poultry, seafood, or other foods that need to be cooked before serving. Follow USDA recommendations for thawing foods.

### WARNING

Food Poisoning Hazard. Do not let food sit for more than one hour before or after cooking. Doing so can result in food poisoning or sickness. Foods that can easily spoil such as milk, eggs, fish, meat, or poultry should be chilled in the refrigerator first. Even when chilled, they should not stand in the oven for more than 1 hour before cooking begins and should be removed promptly when finished cooking. Eating spoiled food can result in sickness from food poisoning.

1. Place the food on the desired oven rack position and slide into the oven.

2. Press **UPPER OVEN** to light up the available cooking modes keys.



3. Press **defrost**.



4. Press **START enter**.



5. Press **CANCEL off** to stop cooking at any time.



## Setting Dehydrate

The dehydrate feature dries with heat from the elements. The heat is circulated throughout the oven by the convection fan. Use dehydrate to dry and/or preserve foods such as fruits, vegetables, herbs, and very thin slices of meat. Dehydrate may be set with cook time and cook time with end time. The following temperature settings apply to the dehydrate feature:

- Auto-suggest (default) setting: 120°F (48°C)
- Minimum dehydrate setting: 100°F (38°C)
- Maximum dehydrate setting: 225°F (108°C)

**To set dehydrate at the default temperature of 120°F (48°C):**

1. Place the food on the desired oven rack position and slide into the oven.

2. Press **UPPER OVEN** to light up the available cooking modes keys.



3. Press **dehydrate**.



4. Press **START enter**.



5. Press **CANCEL off** to turn off dehydrate at any time.



**To add or change any cook settings after this feature has started:**

- To change temperature settings, use the **+hi** or **-lo** keys to increase or decrease the oven temperature by ±5°F (±2°C).
- If changing cooking times, use cook time or end time to make the changes. Refer to [“Cook Time”](#) and [“Setting Cook Time with End Time”](#) on page 24 for instructions on how to use these features.

**For best results:**

- Dry most fruits and vegetables at 140°F (60°C). Dry herbs at 100°F (38°C).
- Drying times vary depending on the moisture and sugar content of the food, the size of the pieces, the amount being dried, and the humidity in the air.
- Treat fruits with antioxidants to avoid discoloration.
- Tightly woven cooling racks can be used to allow the air to circulate around the food; or use drying racks to allow the air to circulate around the food (this type of oven rack is not supplied with this appliance).
- Consult a food preservation book or library for information.
- The convection fan will turn off when the door is opened. Be sure to not open the oven door too often during the dehydrating process. The fan will resume operating when the door is closed.

## Setting Bread Proof

The bread proof feature maintains a warm environment useful for rising yeast-leavened products. Bread proof can be set with the following options: cook time or cook time with end time. The following temperature settings apply to the bread proof feature:

- Auto-suggest (default) setting: 100°F (38°C)
- Minimum bread proof setting: 85°F (30°C)
- Maximum bread proof setting: 100°F (38°C)

### For best results:

- No need to preheat for this feature.
- Proof bread until dough has doubled in bulk.
- Lightly cover the dough.
- Place a shallow pan with 1 to 3 cups of boiling water on the lowest rack position to keep the air moist inside the oven cavity.
- Allow at least 1" between edge of pan and walls of oven.
- Use the oven light to check progress. Do not open the oven door.

### To set bread proof for 85°F (30°C):

1. Place dough on the desired oven rack position and slide into the oven.
2. Press **UPPER OVEN** to light up the available cooking modes keys.
3. Press **bread proof**. The default temperature of 100°F will appear in the display.
4. Enter **8 5** using the numeric keypad.
5. Press **START enter**.
6. Press **CANCEL off** to turn off bread proof at any time.



85



## Slow Cook

Slow cook may be used to cook foods more slowly, at lower oven temperatures and provide cooking results much the same way as a slow cooker or crock-pot. Slow cook is ideal for roasting beef (ribs and brisket), pork, and poultry. It may be set with cook time, cook time/end time, probe, and multi stage. Slow cooking meats may result in the exterior of meats becoming dark but not burnt. This is normal. Slow cook uses the hidden bake element to maintain a low temperature in the oven. The meat probe cannot be used in this cooking mode. There are two settings available, high (HI) or low (LO). The maximum cook time for slow cook is 12 hours unless the oven control has been changed to the continuous bake mode.

### To set slow cook with a low setting:

#### ⚠ WARNING

Food Poisoning Hazard. Do not let food sit for more than one hour before or after cooking. Doing so can result in food poisoning or sickness. Foods that can easily spoil such as milk, eggs, fish, meat, or poultry should be chilled in the refrigerator first. Even when chilled, they should not stand in the oven for more than 1 hour before cooking begins and should be removed promptly when finished cooking. Eating spoiled food can result in sickness from food poisoning.

#### ⚠ CAUTION

Always use potholders or oven mitts when removing food or adjusting the oven racks. Wait until the oven is completely cooled if possible. When cooking, the oven interior and oven racks will become hot enough to cause burns.

1. Place the food on the desired oven rack position and slide into the oven.
2. Select an oven by pressing either **UPPER OVEN** or **LOWER OVEN** to light up the available cooking modes keys.
3. Press **slow cook**. The default setting **Hi** appears in the display. If you need a low setting, press **-lo** to select the **Lo** setting.
4. Press **START enter**. To change any cook settings after slow cook has started, press **+hi** or **-lo** and release.
5. Press **CANCEL off** to stop slow cook at any time.



If changing cooking times, use cook time or end time to make the needed changes. Refer to [“Cook Time”](#) and [“Setting Cook Time with End Time”](#) on [page 24](#) for instructions on how to use these features.

**For best results:**

- Slow cooking meats may result in the outside of the meat turning dark; this is normal. Completely thaw all frozen foods before cooking.
- Arrange food in center of oven. Position multiple racks to accommodate size of cooking utensils when baking multiple food items. Add any cream or cheese sauces during the last hour of cooking.
- Do not frequently open the oven door or leave the oven door open when checking food items. The more heat that is lost, the longer the food will need to cook.
- Cover foods to keep them moist or use a loose or vented cover to allow foods to turn crisp or brown.
- Roasts may be left uncovered so browning can occur. Cook times will vary depending on the weight, fat content, bone, and the shape of the roast.

**SETTING MULTI STAGE**

Use multi stage to perform sequential cooking at the touch of a button. Its purpose is to program a queue of up to three cooking modes with individual cooking time and temperatures in a sequence. This feature can be used with bake, broil, convection bake, convection roast, convection broil, and keep warm. A cook time can be programmed with the desired cooking mode and then queued. Be sure to follow recipe suggestions when determining how to best set multi stage.

For example, the first stage might be a short duration with a higher than normal cooking temperature to rapidly start the cooking process. A second stage at a normal temperature would allow for a longer, more normal cooking time. A final stage can be set for holding the cooked food at serving temperature by setting keep warm as the final stage. During stage 1 baking, the electronic control provides temperature visual output in the display. During stage 2 and 3, the electronic control displays the set temperature only.

**IMPORTANT!** A proper cook time and a set temperature are required for every stage programming. At least two stages must be programmed before multi stage cooking operation starts.



Any stage programmed with broil or convection broil cannot last longer than 10 minutes.

**IMPORTANT!** Be sure to run the rapid preheat feature to get the oven up to the desired temperature before starting a multi stage operation. See "Rapid Preheat" on page 22.

**To set a (2) multi stage feature for a casserole with:**

- For stage 1, bake at 400°F (204°C) for 1 hour; and
- For stage 2, brown, broil for at 500°F (260°C) for 4 minutes, using 2 stages of this feature:

**CAUTION**

Always use pot holders or oven mitts when working with a hot oven. When baking, the oven interior and oven racks will become hot enough to cause burns.

1. Place the food on the desired oven rack position and slide into the oven.
2. Press **UPPER OVEN** to light up the available cooking modes keys.



3. Press **multi stage**.



----- **STAGE 1** appears in the display -----

4. Press **bake**.



bake

5. Enter the temperature of **4 0 0** using the numeric keypad.

**400**

6. Press **START enter**.



7. Enter **6 0** minutes using the numeric keypad.

**60**

8. Press **START enter**. This sets the first stage of cooking and **stage 2** will show in the display allowing you to program the desired next step.



----- STAGE 2 -----

9. Press **broil**.



10. Enter **5 0 0** degrees using the numeric keypad.

**500**

11. Press **START enter**.



12. Enter **4** minutes using the numeric keypad.

**4**

13. Press **START enter** twice. This will program the 2 stages and begin cooking.



14. Press **CANCEL off** to stop multi stage cooking at any time.



### Setting Multi Stage for Three Stages

When all three stages of cooking are preferred, setting the multi stage feature requires a few easy steps. Each stage may be programmed with a cooking feature, set temperature, and a cook time. Using three stages is ideal when you want to add a keep warm after using two cooking functions.

#### To program a (three stage) multi stage feature for a casserole with:

- For stage 1, bake at 350°F (176°C) for 1 hour;
- For stage 2, brown, broil for 500°F (260°C) for 4 minutes; and
- For stage 3, keep warm at 170°F (76°C) for 15 minutes.

#### **CAUTION**

Always use pot holders or oven mitts when working with a hot oven. When baking, the oven interior and oven racks will become hot enough to cause burns.

1. Place the food on the desired oven rack position and slide into the oven.
2. Press **UPPER OVEN** to light up the available cooking modes keys.



3. Press **multi stage**.

**1 2 3**  
multi stage

----- **STAGE 1** appears in the display-----

4. Press **bake**.



5. Enter **3 5 0** using the numeric keypad.

**350**

6. Press **START enter**.



7. Enter **6 0** minutes using the numeric keypad.

**60**

8. Press **START enter**.









----- **STAGE 2** appears in the display-----

9. Press **broil**.



10. Enter **5 0 0** using the numeric keypad.

**500**

11. Press **START enter**.   
START  
enter
12. Enter **4** minutes using the numeric keypad. **4**
13. Press **START enter**.   
START  
enter
- **STAGE 3** appears in the display -----
14. Press **keep warm**.   
keep  
warm
15. Press **START enter**.   
START  
enter
16. Enter **1 5** minutes using the numeric keypad. **15**
17. Press **START enter**.   
START  
enter
18. Press **CANCEL off** to stop multi stage cooking at any time.   
CANCEL  
off

## THE LOWER OVEN

The lower oven is ideal for cooking foods such as pizza, casseroles, baked potatoes and frozen convenience foods. Available cooking functions for this mini oven are bake, keep warm, and slow cook. The available cooking options are cook time, end time, and favorites.

The following temperature settings apply to the bake feature for the lower oven:

- Auto-suggest (default) setting: 350°F/176°C
- Min. bake setting: 170°F / 76°C
- Max. bake setting: 450°F / 232°C

### To set bake for the lower oven:

#### **⚠ WARNING**

Keep children away from the lower oven when hot. Failure to do so can result in burns.

#### **⚠ WARNING**

Should an oven fire occur, close the drawer and turn the lower oven OFF. If the fire continues, use a fire extinguisher. DO NOT put water or flour on the fire. Flour may be explosive.

#### **⚠ CAUTION**

Always use pot holders or oven mitts when working with a hot oven. When baking, the oven interior and oven racks will become hot enough to cause burns.

#### **⚠ CAUTION**

Do not bake foods directly on the oven bottom. To avoid damaging the oven interior and surfaces, always bake foods in the oven using bakeware positioned on an oven rack

1. Press **LOWER OVEN** to light up the available cooking modes keys.
2. Press **bake**. The default oven temperature of 350°F (176°C) appears in the display.
3. Press **START enter**. To add or change any bake settings once the oven is baking, make temperature changes using the +hi or -lo keys. Each press will adjust the temp by ±5°F (±2°C).
4. When Bake is active the oven begins to preheat. Display will show **PRE-HEATING**. When the oven reaches the set temp, the control sounds a tone to signal oven is ready.
5. To stop bake at any time, press **CANCEL off**.



### Lower Oven Baking Tips

- When using the lower oven, limit the number of times the drawer is opened; this will minimize heat loss. Repeated opening of the drawer during the cooking process may increase cooking times and produce uneven cooking results. The cooking times for the lower oven may vary slightly from the upper oven.
- Do not use plastic wrap to cover food. Plastic may melt onto the lower oven or surrounding areas and be very difficult to clean. Use a lid or aluminum foil instead. Use only utensils and cookware in the lower oven that are recommended for oven use in the upper oven.
- Use pans in the lower oven large enough to contain food and any juices created from the cooking process.
- The maximum height of foods and utensils that may be used in the lower oven is 4". The maximum width is 15". Pay close attention to foods that have potential to rise beyond the recommended 4" maximum height.
- DO NOT LINE THE OVEN DRAWER WITH FOIL OR COVER THE OVEN RACK WITH FOIL. This may result in damage to your oven.
- When placing food in the lower oven always use a baking sheet or pan with 4 raised sides to prevent food from sliding off.
- The lower oven rack must always be in place when cooking or warming. Be sure that the rack is placed with the down turned sides into the drawer. This will provide for some air space between the drawer and the food.

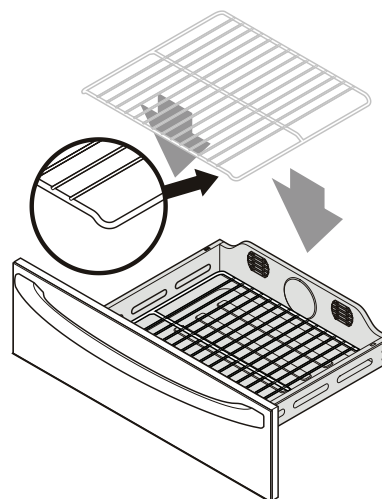

Figure 41: Rack positions



## MY FAVORITE

The my favorite settings allows you to save your most frequently used or most complex cooking sequences. This feature will save the cooking mode, the target temperature, and the cook time (if any). The my favorite feature stores and recalls up to three favorite recipe settings, which are easily accessible from a one touch key. This feature will only store or recall one favorite recipe at a time from each of the three my favorite keys on the control display.

My favorite may be used with bake, cook time, convection bake, convection roast, slow cook, and keep warm, and it will not work with any other feature, including end time, broil, or self clean.

### IMPORTANT!

The my favorite cooking option is available in both the top oven and in the lower, mini oven. Since bake, keep warm, and slow cook are the only cooking functions available in the lower oven, then any favorites created for the lower oven will be limited to bake, keep warm, and slow cook.

### To set a favorite recipe (example: bake for 30 minutes with oven temperature of 325°F (162°C)):

#### CAUTION

Always use pot holders or oven mitts when working with a hot oven. When baking, the oven interior and oven racks will become hot enough to cause burns.

1. Place the food on the desired oven rack position and slide into the oven.

2. Select an oven by pressing either **UPPER OVEN** or **LOWER OVEN** to light up the available cooking modes keys.

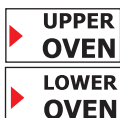

3. Press **bake**. The default oven temperature of **350** appears in the display.



4. Enter **3 2 5** for temp using the numeric keypad.

**325**

5. Press **cook options**.



6. Press **cook time**.



7. Enter **3 0** minutes using the numeric keypad.

**30**

8. Press **START enter**.



9. To store, press and hold one of the three **my favorite** keys for 3 seconds and release when you hear acceptance tone and see the red indicator light above your selection.



10. Press **CANCEL off** to stop the my favorite cooking at any time.



### To use a saved favorite recipe setting:

1. Press **UPPER OVEN** to light up the available cooking modes keys.



2. Press the **my favorite** key of your choice. The saved recipe will appear in the display.



3. Press **START enter**.



### To erase a favorite recipe setting:

1. Press **oven** to light up the available cooking modes keys.

2. Press the **my favorite** key of your choice and hold for 3 seconds, until the my favorite indicator light turns off.



### Adjusting the Oven Temperature

This appliance has been factory calibrated and tested to ensure accurate baking temperatures. For the first few uses, follow all recipe times and temperature recommendations carefully. If you think the oven is cooking too hot or too cool for your recipe times, the control may be adjusted so the oven cooks hotter or cooler than the temperature displayed.

The oven temperature may be increased or decreased  $\pm 35^{\circ}\text{F}$  ( $\pm 19^{\circ}\text{C}$ ) by adjusting the User Programmable Offset (UPO).



Each oven cavity can be set with its own unique UPO setting.

**IMPORTANT!** Do not use oven thermometers such as those found in grocery stores to check oven temperature. These thermometers may vary as much as  $20^{\circ}\text{F}$  to  $40^{\circ}\text{F}$  from actual oven temperatures.

#### How to offset the oven temperature by $+30^{\circ}\text{F}$ :

1. Press **user pref** until **UPO** appears in the upper or lower display. The default setting of **0** should display next to **UPO**.
2. To increase the oven temperature by  $30^{\circ}\text{F}$ , press **+hi** until **3 0** appears next to **UPO**.
3. To accept change, press **START enter**.
4. When finished, press **CANCEL off** to return the oven to an idle mode.



**30**



#### To offset the oven temperature by $-30^{\circ}\text{F}$ ( $-17^{\circ}\text{C}$ ):

1. Press **user pref** until **UPO** appears in the upper or lower display.
2. To decrease the oven temperature by  $30^{\circ}\text{F}$ , press **-lo** until **-30** appears.
3. To accept change, press **START enter**.
4. When finished, press **CANCEL off** to return the oven to an idle mode.



**-30**



Oven temperature adjustments made by changing the UPO setting will not affect the broil or self clean feature temperatures.



Do not use oven thermometers such as those found in grocery stores to check the temperature setting inside the oven. These thermometers may display temperatures that vary greatly from the actual temperature.

## THE SABBATH MODE

(for use on the Jewish Sabbath and Holidays)



For further assistance, guidelines for proper usage, and a complete list of models with the Sabbath feature, please visit the web at <http://www.star-k.org>.

This appliance provides special settings for use when observing the Jewish Sabbath/Holidays.

Sabbath mode disables all audible tones or visual display changes on the oven control. Bake heating is the only cooking features available while in the Sabbath mode.

You must first set the bake feature and temperature(s) needed for the oven, as well as the cook time and delay start options (if needed). Any settings made prior to setting the Sabbath mode will be visible in the displays.

The Sabbath mode will override the factory preset 12-hour Energy Saving mode and the appliance will stay on until the cooking features are cancelled. If any of the cooking features are cancelled when the appliance is in the Sabbath mode, no audible or visual indicators will be available to verify the cancellation.

If the oven interior lights are needed, be sure to activate them prior to setting the Sabbath mode. Once the oven light is turned on and the Sabbath mode is active, the oven light will remain on until the Sabbath mode is turned off and the oven lights are turned off. The oven door will not activate the interior oven lights when the oven door is opened or closed.

It is recommended that any oven temperature modification made within an active Sabbath mode be followed with two presses of the START enter key. This will ensure the oven remains on even if an attempt is made to set the oven temperature outside of its temperature range. If the oven temperature is set outside of the temperature range, the oven will default to the nearest available temperature. Try to set the desired oven temperature again.

**To program oven to bake with default oven temperature of 325°F (162°C) and activate the Sabbath feature:**

### **⚠ WARNING**

Food Poisoning Hazard. Do not let food sit for more than one hour before or after cooking. Doing so can result in food poisoning or sickness. Foods that can easily spoil such as milk, eggs, fish, meat, or poultry should be chilled in the refrigerator first. Even when chilled, they should not stand in the oven for more than 1 hour before cooking begins and should be removed promptly when finished cooking. Eating spoiled food can result in sickness from food poisoning.

### **⚠ CAUTION**

Always use pot holders or oven mitts when working with a hot oven. When baking, the oven interior and oven racks will become hot enough to cause burns.

1. Be sure the clock is set to the correct time of day.
2. Place the food on the desired oven rack position and slide into the oven.

3. Select an oven by pressing either **UPPER OVEN** or **LOWER OVEN** to light up the available cooking modes keys.

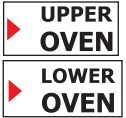

4. Press **bake**.



5. Enter **3 2 5** using the numeric keypad.

**3 2 5**

6. If you desire to set the oven control for cook time or end time, select **cook options**. If not, skip this step and continue to step 8.



7. If entering both cook time and end time for delay bake, the oven will automatically calculate the start time. Refer to “Cook Time” and “Setting Cook Time with End Time” on page 24 for instructions on how to use these features.



**IMPORTANT!** Remember the oven will shut down after using cook time and therefore may only be used once during the Sabbath/Jewish Holidays.

8. Press **START enter**. The oven will turn on and begin heating immediately.



9. To enter Sabbath mode, press and hold both **+ hi** and **- lo** keys together for 3 seconds. Release the keys when you hear a chime.



Once **SAb** appears in the display, the oven control will no longer chime or display any further changes, and the oven is properly set for the Sabbath feature.



**Figure 42: Sabbath Mode display**

**IMPORTANT!** The keys available once the oven is set to Sabbath mode are bake, start, cancel, and the numeric keypad. Cook time and end time are available before Sabbath mode is set.

10. To change the oven temperature once baking has started and the oven is in Sabbath mode, press **+ hi** or **- lo**. Each press of a key will raise (+) or lower (-) the temperature in  $\pm 5^{\circ}\text{F}$  ( $\pm 2^{\circ}\text{C}$ ) increments. Remember that the oven control will no longer chime or display further changes once the oven is in Sabbath mode.



11. The oven may be turned off at any time by pressing **CANCEL off**.



12. Pressing **CANCEL off** will not turn off the Sabbath feature. To cancel Sabbath mode, press and hold **+ hi** and **- lo** keys together for 3 seconds. **SAb** will disappear from the display.

**+ -**  
**hi lo**

**IMPORTANT!** Remember the oven will shut off after completing a cook time or end time and therefore may only be used once during the Sabbath/Jewish holidays. The maximum cook time setting is 11 hours and 59 minutes.

#### What to do after a power failure or power interruption when Sabbath mode is active

If a power failure or interruption occurs during the Sabbath/Holidays, the appliance will shut off. **SF** will appear in all the control display, indicating a Sabbath mode failure (Figure 43).



**Figure 43: Sabbath Failure**

When power is returned, the oven will not turn back on automatically. The oven will remember that it is set for the Sabbath, and the food may be safely removed from the oven while still in the Sabbath mode; however, the oven cannot be turned back on until the Sabbath mode is cancelled. After Sabbath mode is cancelled, Sabbath mode settings may be entered again, if it's still needed.

1. To cancel Sabbath mode, press and hold **+ hi** and **- lo** together for 3 seconds.
2. **SAb** will disappear from the display, and the oven may be used with all normal functions.

**+ -**  
**hi lo**

## Restoring the Factory Default Settings

Your appliance is set with a number of predetermined oven control settings. Over time you may make changes to the original factory settings. The following options may have been modified since the appliance was new:

- Clock 12-hour or 24-hour display mode
- 12-Hour Energy Savings or continuous bake mode
- Tone volume
- Oven temperature display (Fahrenheit or Celsius)
- Any oven temperature adjustment made (UPO)
- Clock Display On or Off
- Any saved recipes

**IMPORTANT!** Before restoring, be aware that any previous changes made to the oven control settings will be erased once the numeric keypad is pressed. This includes any temperature offset made for the oven when baking.

#### To restore factory default settings:

1. Press **user pref** until **rSt no** or **rSt YES** appears in the display (Figure 44).
2. Press **+hi** until **rSt YES** appears in the display.
3. Press **START enter** to accept.



**Figure 44: Oven ready to reset to default settings**

## SELF CLEAN

A self cleaning oven automatically cleans itself by using much higher temperatures than those used for baking. The self clean feature eliminates soils completely or reduces them to a fine powdered ash that, when the oven has cooled, can be wiped away easily with a damp cloth.

The self clean function provides three different clean time settings for self clean. Set clean for 2 hours for light, 3 hours for normal, or 4 hours for heavier soils.

### Before starting self clean:

#### **⚠ WARNING**

Do not leave small children unattended near the appliance. During the self clean cycle, the outside of the oven can become very hot to touch and can cause burns.

#### **⚠ CAUTION**

Do not force the oven door open when self clean is active. This can damage the automatic door-locking system. Use caution when opening the door after self cleaning. The oven may still be very hot and can cause burns. To avoid possible burns, stand to one side of the oven when opening the oven door to allow hot air or steam to escape.

#### **⚠ CAUTION**

The health of some birds is extremely sensitive to the fumes given off during the self clean cycle of any wall oven. Move birds to another well-ventilated room.

#### **⚠ CAUTION**

Do not line the oven walls, oven racks, oven bottom or any other part of the oven with aluminum foil. Doing so will stop heat distribution, produce poor baking results, and may cause permanent damage to the oven interior. Aluminum foil will melt to a hot oven surface during self clean.

#### **⚠ CAUTION**

The oven bake and broil elements may appear to have cooled after they have been turned off. The elements may still be hot and burns may occur if these elements are touched before they have cooled.

- Remove all items from the oven including bakeware, utensils, accessories, and any aluminum foil. Aluminum foil will not withstand high temperatures from a self clean cycle and will melt.
- Remove any excessive build up caused by spills. Any spill on the oven bottom should be wiped up and removed before starting a self clean cycle. To clean, use hot, soapy water and a cloth. Large spill residue can cause heavy smoke or fire when subjected to high temperatures. Do not allow food spills with a high sugar or acid content (such as milk, tomatoes, sauerkraut, fruit juices, or pie filling) to remain on the surface as they may leave a dull spot even after cleaning.
- Do not clean the oven door gasket (Figure 45). The woven material of the oven door gasket is essential for a good seal. Care should be taken not to rub, damage, or remove the gasket. Do not use any cleaning materials on the oven door gasket. Doing so could cause damage to the door gasket.

- Do not use oven cleaners or oven protective coatings in or around any part of the oven interior. Residue from oven cleaners may damage the porcelain during the next self-clean cycle.
- Clean any soil from the oven frame, the door liner outside the oven door gasket and the small area at the front center of the oven bottom (Figure 45). These areas heat sufficiently to burn soil on. Clean using soap and water prior to starting self clean.

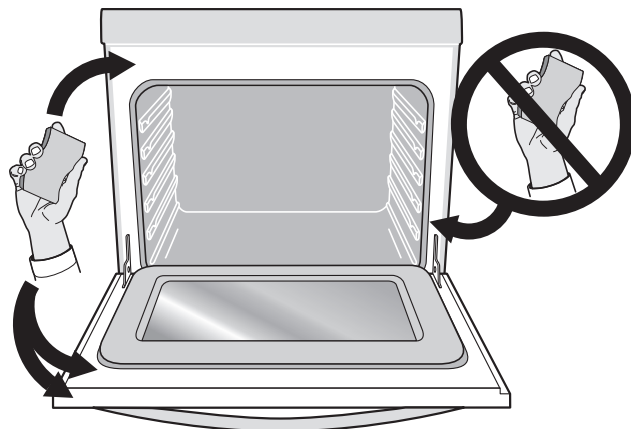

**Figure 45: Oven door area to clean and not clean (gasket)**

### Porcelain coated oven racks

- This oven comes with lubricated porcelain oven racks, which can remain in the oven during the self-clean cycle. Do not clean this vegetable oil lubrication off the racks. It is important that the sides of the oven racks always have a light coating of vegetable oil. To maintain optimal rack performance, re-apply a thin layer of vegetable oil to the sides of the rack after every self-clean cycle or when the rack becomes difficult to slide.

## Setting Self Clean

### ⚠ WARNING

Do not leave small children unattended near the appliance. During the self clean cycle, the outside of the oven can become very hot to touch and can cause burns.

### ⚠ CAUTION

Do not force the oven door open when self clean is active. This can damage the automatic door-locking system. Use caution when opening the door after self cleaning. The oven may still be very hot and can cause burns. To avoid possible burns, stand to one side of the oven when opening the oven door to allow hot air or steam to escape. The self clean feature will not operate if the lower or upper oven is on.

**IMPORTANT!** The kitchen area should be well ventilated. Use an open window, ventilation fan, or exhaust hood during the first self clean cycle to help eliminate the normal odors associated the initial clean cycle.

#### To start a self clean:



1. Ensure the oven is empty and remove all oven racks. Be sure the clock is set with the correct time of day and the oven door is completely closed.
2. Press **UPPER OVEN** to light up the available cooking modes keys. 
3. Press **clean**. 
4. The self clean feature allows you to choose one of three time options. Press **lite** for a 2-hour clean (Figure 46); or 



Figure 46: 2 hour lite clean

5. Press **med** (normal) for a 3-hour clean (Figure 47); or 



Figure 47: 3 Hour normal clean

6. Press **heavy** for a 4-hour clean (Figure 48). 



Figure 48: 4 Hour heavy clean

7. Press **START enter** to begin cleaning. 

Once active, the door lock motor will begin locking the oven door. **DOOR** will blink in the display.

- Do not try to open the door when the **DOOR** message is blinking or once it is on (allow about 15 seconds for the oven door to completely lock).
- Once the oven door is locked the **CLn** message will appear in the display for the entire self clean cycle.

#### When the self clean cycle is finished:

### ⚠ WARNING

Use caution when opening the oven door after self cleaning. The oven may still be very hot and can cause burns. To avoid possible burns, stand to the side of the oven when opening the oven door to allow hot air or steam to escape. The oven bake and broil elements may appear to have cooled after they have been turned off. The elements may still be hot, and burns may occur if these elements are touched before they have cooled.

1. The time of day and **Hot** will show in the display (Figure 49).
2. Once the oven has cooled (about 1 hour) and **Hot** is no longer displayed, the **door lock** message will flash. When this message stops flashing in the display, the door has finished unlocking and may be opened.



Figure 49: Hot oven (door still locked)

### ⚠ CAUTION

The oven bake and broil elements may appear to have cooled after they have been turned off. The elements may still be hot and burns may occur if these elements are touched before they have cooled.

3. After the oven has cooled, wipe away any residue or powdered ash from the oven interior using a damp cloth or paper towel.



A self clean cycle will not start if the control lock feature is active. If a self clean cycle was started but did not finish due to a power outage, your oven may not have completely cleaned.

**To cancel self clean:**

1. Press **CANCEL off**.



**WARNING**

Use caution when opening the oven door after self cleaning. The oven may still be very hot and can cause burns. To avoid possible burns, stand to the side of the oven when opening the oven door to allow hot air or steam to escape. The oven bake and broil elements may appear to have cooled after they have been turned off. The elements may still be hot, and burns may occur if these elements are touched before they have cooled.

2. If the self clean cycle has heated the oven to a high enough temperature, **Hot** will appear in the display (Figure 50). Allow enough time for the oven to cool and the door to unlock before the oven door may be opened.



**Figure 50: Oven too hot for door to unlock**

**IMPORTANT!** Before restarting self clean, read the following important notes:

- If your clock is set with the (default) 12 hr display mode, the delay start for a self clean can only be programmed to start up to 11 hours and 59 minutes after the time showing in the display (be sure to set the clock to current time before programming a delay start). To set a delay start self clean to begin 12 or more hours (maximum is 23 hours and 59 minutes) after the time of setting, be sure to first set the control in the 24 Hr display mode.
- If self clean was active and then interrupted by a power failure or cancelled before the oven was thoroughly cleaned, it may be necessary to run another self clean cycle.

**Setting Delayed Self Clean**

You may want to set the oven to perform a self clean at a later time (up to 12 hours later). The end time key will determine when the cleaning will stop. The end time must be set far enough from the real time to allow for the type of clean cycle you select, whether 2, 3, or 4 hours. Remember to add 30 to 40 additional minutes of cooling time before using the oven for cooking.



If you want to set a delayed self clean to end between 12 and 24 hours, use the user pref key to set the 12hr energy saving mode (ES) to Off and also set the clock (CLO) to the 24 hr mode.

**Setting for a heavy (4 hour) self clean cycle to end at 8:00 o'clock:**

**WARNING**

Do not leave small children unattended near the appliance. During the self clean cycle, the outside of the oven can become very hot to touch and can cause burns.

**CAUTION**

Do not force the oven door open when self clean is active. This can damage the automatic door-locking system. Use caution when opening the door after self cleaning. The oven may still be very hot and can cause burns. To avoid possible burns, stand to one side of the oven when opening the oven door to allow hot air or steam to escape.

**IMPORTANT!** The kitchen area should be well ventilated. Use an open window, ventilation fan, or exhaust hood during the first self clean cycle to help eliminate the normal odors associated the initial clean cycle.

1. Ensure the oven is empty and remove all oven racks and racks support. Be sure the clock is set with the correct time of day and the oven door is completely closed. In this example, the time of day should be earlier than 4:00 o'clock.

2. Press **UPPER OVEN** to light up the available cooking modes keys.



3. Press **clean**.



4. Press **heavy**.



5. Press **cook options**. The end time icon will appear.



6. Press **end time**. The numeric keypad will illuminate.



7. Enter **8 0 0** on the numeric keypad.

**8 0 0**

8. Press **START enter**. The display will indicate the time remaining before self clean begins. When the self clean cycle begins, the display will show the time remaining in the self clean cycle.



# CARE AND CLEANING

---

## Cleaning Various Parts of Your Oven

Before cleaning any part of the oven, be sure all controls are turned off and the oven is cool. Remove spills and any heavy soiling as soon as possible. Regular cleaning will reduce the difficulty and time of major cleaning later.

Surface Type	Recommendation
<b>Control knobs</b> <b>Painted body parts</b> <b>Painted decorative trim</b> <b>Aluminum, plastic, or vinyl trim</b>	For general cleaning, use hot soapy water and a cloth. Dry with a clean cloth. For more difficult soils and build-up grease, use a soft cloth and clean with mild dish detergent and water or a 50/50 solution of vinegar and water. Follow by rinsing the area with clean water; dry and polish with a soft cloth. Glass cleaners may be used if sprayed on a soft cloth first. Do not spray liquids directly on the oven control and display area. Do not use large amounts of water on the control panel. Excess water on the control area may cause damage to the appliance. Do not use other liquid cleaners, abrasive cleaners, scouring pads, or paper towels. They will damage the finish.
<b>Control panel</b> <b>Control keypad membrane</b> <b>Decorative trim (some models)</b>	Before cleaning the control panel, turn all controls off and activate oven lockout (on some models). Do not use abrasive cleaners on any of these materials; they can scratch. Clean using hot, soapy water and a cloth or sponge. Be sure to squeeze excess water from cloth or sponge before wiping control panel, especially when wiping around the controls area. Excess water in or around the controls may cause damage to the appliance.
<b>Porcelain enamel parts</b>	Gentle scrubbing with a soapy non-abrasive scouring pad will remove most spots. Rinse with a 1:1 solution of clear water and ammonia. If necessary, cover difficult spots with an ammonia-soaked paper towel for 30 to 40 minutes. Rinse with clean water and a damp cloth, and then scrub with a soap-filled non-abrasive scouring pad. Rinse and wipe dry with a clean cloth. Do not allow food spills with high sugar or acid content (milk, tomatoes, sauerkraut, fruit juices, or pie filling) to remain on the surface; they may cause a dull spot even after cleaning.
<b>Oven interior</b>	Remove excessive spillovers from oven cavity bottom before starting Self Clean. Clean any soils from oven frame and door liner outside the oven door gasket. For very important cleaning precautions, be sure to read all the <a href="#">“Self Clean”</a> instructions on <a href="#">page 45</a> .
<b>Porcelain coated oven racks</b>	This model comes with lubricated porcelain oven racks, which can remain in the oven during the self-clean cycle. Do not clean this vegetable oil lubrication off the racks. It is important that the sides of the oven racks always have a light coating of vegetable oil. To maintain optimal rack performance, re-apply a thin layer of vegetable oil to the sides of the rack after every self-clean cycle or when the rack becomes difficult to slide.  For instructions on how to care for your Glide Racks, see <a href="#">“Caring for Your Glide Racks”</a> on <a href="#">page 51</a> .
<b>Oven door</b>	Use soap and water to thoroughly clean the top, sides, and front of the oven door. Rinse well. You may use a glass cleaner on the outside glass of the oven door. Do not immerse the door in water. Do not spray or allow water or the glass cleaner to enter the door vents. Do not use oven cleaners, cleaning powders, or any harsh abrasive cleaning materials on the outside of the oven door.
<b>Cooktop surface</b>	Do not use spray oven cleaners on the cooktop. See <a href="#">“General Care &amp; Cleaning”</a> and <a href="#">“Cleaning the Cooktop and Surface Burners”</a> on <a href="#">page 49</a> .
<b>Stainless Steel (some models)</b>	Always rub in direction of metal grain to avoid damaging. Do not use cleaners with high concentrations of chlorides or chlorine. Do not use harsh scrubbing cleaners. Polish with a lint-free cloth. Always be sure to wipe excess cleaner/polish off from the metal surface as bluish stains may occur during future oven heating that cannot be removed. Clean heavier soils with hot, soapy water and a cloth or sponge. Rinse and dry using clean water and a cloth.

---



## General Care & Cleaning

The cooktop is designed to make cleaning easier. Because the gas burners are sealed, cleanups are easy when spillovers are cleaned up immediately. Correct and consistent cleaning is essential to maintaining your porcelain enamel cooktop. If food spills and grease spatters are not removed, they may burn onto the surface of the cooktop and cause permanent discoloration.

### ⚠ WARNING

Do not use a cooktop cleaner on a hot cooktop. The fumes can be hazardous to your health and can chemically damage the cooking surface.

### ⚠ CAUTION

Before manually cleaning any part of the range, be sure all controls are turned off and the range is cool. The range may be hot and can cause burns.

### ⚠ CAUTION

Ammonia must be rinsed before operating the oven. Provide adequate ventilation.

### ⚠ CAUTION

Do not use commercial oven cleaners on the cooktop.

## Broiler Pan Cleaning Tips

To make cleaning easier, line the bottom of the broiler pan with aluminum foil. Do not cover the broiler grid with foil.

To prevent grease from baking on, remove the broiler pan from the oven as soon as cooking is completed. Use hot pads because the broiler pan is extremely hot. Pour off grease. Soak the pan in hot, soapy water.

Clean the broiler pan as soon as possible after each use. If necessary, use soap-filled steel wool pads. Heavy scouring may scratch the grid.

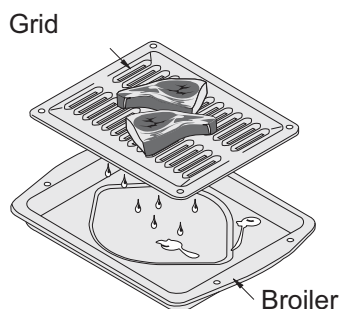

Figure 51: Broiler pan and grid

## Cleaning the Cooktop and Surface Burners

### ⚠ CAUTION

To avoid possible burns, do not attempt any of the cooktop cleaning instructions provided before turning OFF all of the surface burners and allow them to completely cool.

### ⚠ CAUTION

Any additions, changes or conversions required in order for this appliance to satisfactorily meet the application needs must be made by an authorized qualified agency.

### ⚠ CAUTION

To avoid possible burns, do not attempt to operate the surface burners without the burner caps.

Routinely clean the cooktop. Wipe with a clean, damp cloth and wipe dry to avoid scratches.

Keeping the surface burner head ports and slots clean will prevent improper ignition and an uneven flame.

### IMPORTANT!

Your appliance is shipped with the burner heads and burner caps in the correct locations. Before using your gas appliances be sure to follow the installation instructions before operating and remove all packing tape from the cooktop area.

### Cleaning recessed and contoured areas of cooktop

If a spill occurs on or in the recessed or contoured areas, blot up spill with an absorbent cloth. Rinse with a clean, damp cloth and wipe dry.

### Cleaning surface burner grates

- Clean only after the grates are completely cool.
- Use nonabrasive plastic scrubbing pad and mild abrasive cleanser or clean in the dishwasher.
- Food soils containing acids may affect the finish. Clean immediately after the grates are cool.
- Thoroughly dry grates immediately following cleaning.

### Cleaning burner caps

- Remove caps from burner heads after they have cooled.
- Clean heavy soils with a plastic scrubbing pad and absorbent cloth.
- Thoroughly dry burner caps immediately following cleaning including the bottom and inside of cap.
- Do not use abrasive cleaners. They can scratch porcelain.
- Do not clean burner caps in the dishwasher.
- Do not operate surface burners without burner caps properly in place. Read important notes.

## CLEANING SURFACE BURNER HEADS

For proper gas flow it may be necessary to clean the burner head and slots. To clean, first use a clean DAMP cloth to soak up any spills. Remove any food from between the burner slots using a small nonabrasive brush like a toothbrush and afterwards wipe up using a damp cloth. For stubborn soils located in the slots, use a small-gauge wire or needle to clean.

Any spill on or around the electrode must be carefully cleaned. Take care not to hit the electrode with any thing hard or it could be damaged.

### IMPORTANT!

Small food particulars on or around the electrode could stop the burner from lighting.

### To clean the burner head ignition ports

Each burner head has a small ignition port located as shown. Should you experience ignition problems it may be that this port hole is partially blocked with soil. With the burner head in place, use a small wire gauge needle or the end of a paper clip to clear the ignition port (Figure 52; round style shown; oval burner on some models not shown).

### IMPORTANT!

- The surface burner heads are secured to the cooktop and must be cleaned in place on the cooktop.
- Always keep the surface burner caps in place whenever a surface burner is in use.
- When replacing the burner caps, be sure the burner caps are seated firmly on top of the burner heads. Improper flame size and uneven heating may result when any surface burners are turned on and the burner caps are not seated correctly.
- For proper flow of gas and ignition of burners do not allow spills, food, cleaning agents or any other material to enter the gas orifice port opening.

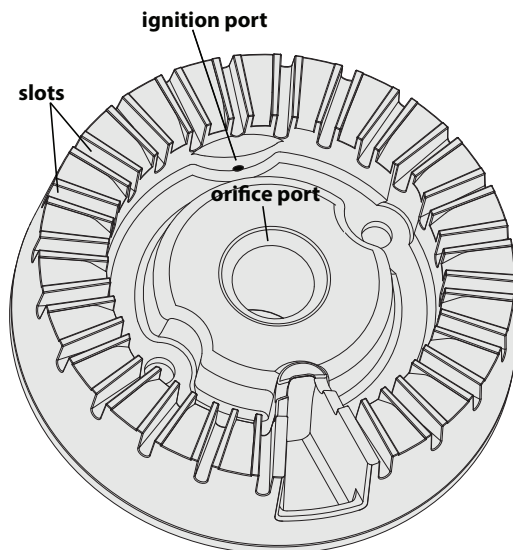

Figure 52: Cooktop burner head

### Double ring burner cap

The glass in the double ring is designed to fit loosely. Clean with normal non abrasive glass type cleaner and thoroughly dry before replacing.

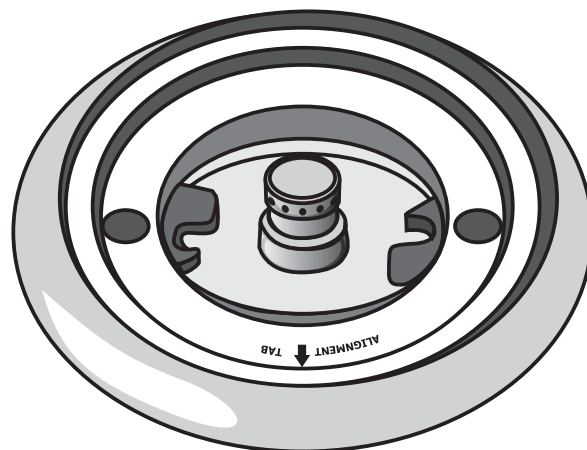

Figure 53: Double ring burner head

### Re-installing the G5 burner:

Place the burner head over the gas orifice (Figure 54). Be careful not to damage the electrode while placing the burner head over the orifice. Make sure electrode fits correctly into slot in burner head.

**IMPORTANT!** For proper ignition, the burner ring alignment tab must align with burner base alignment tab slot.

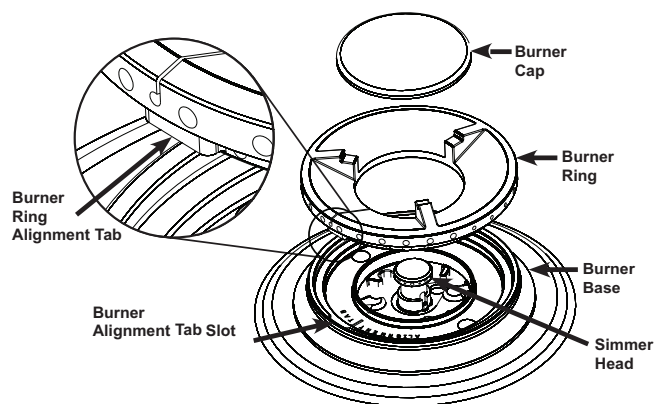

Figure 54: Setting G5 burner correctly



When the burner ring is properly seated, it will click into place. When the burner cap is properly set in place, it should not move out of the recessed area of the burner head.

## CARING FOR YOUR GLIDE RACKS

### ⚠ CAUTION

Handle oven racks only when they are cool. After cooking or after the self clean cycle, racks will be very hot and can cause burns.

#### Important Notes:

- The Glide Rack is porcelain enameled and may be left in the oven to be cleaned during the self-clean cycle. After the cycle, or anytime the gliding is rough, the glide rack extension tracks should be treated with graphite lubrication.
- Do not use cooking oil, cooking spray, or other oil-based lubrication products on the glide rack extension tracks. Use only the graphite lubrication in this area. To order graphite lubrication, contact your installer, servicer or dealer.
- It is important that the parts of the rack that contact the oven sides always have a light coating of vegetable oil. Apply a thin layer of vegetable oil to the sides of the rack when the rack becomes difficult to reposition in the oven.

#### To lubricate the glide rack:

1. Remove the rack from the oven and place the rack on a large flat surface covered with newspaper or scrap cloth. Fully extend the rack.
2. Wipe away debris and crumbs from the glide track using a cloth or sponge.

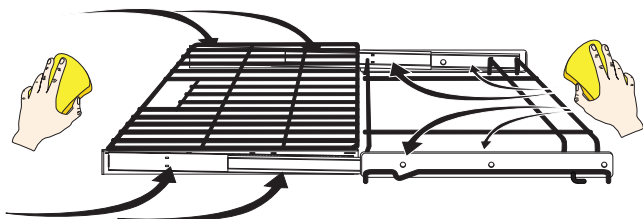

3. Shake graphite lubrication very well before applying. Place four drops of graphite lubrication along the tracks (see area circled on figure below). Repeat on both sides of the glide rack.

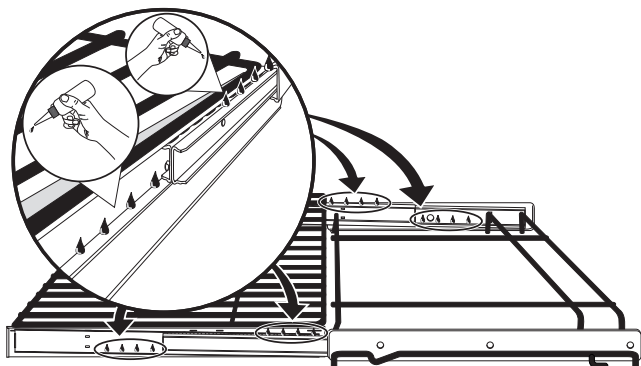

4. Extend and return the glide rack several times along the tracks to distribute the lubrication.

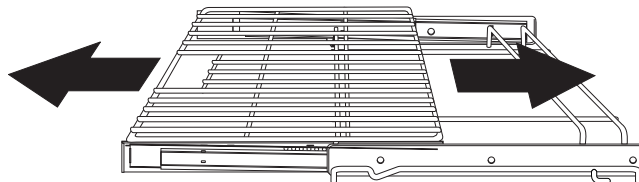

5. Turn glide rack over. Shake graphite lubrication very well before applying. Place four drops of graphite lubrication along the tracks. Repeat on both sides of the glide rack.

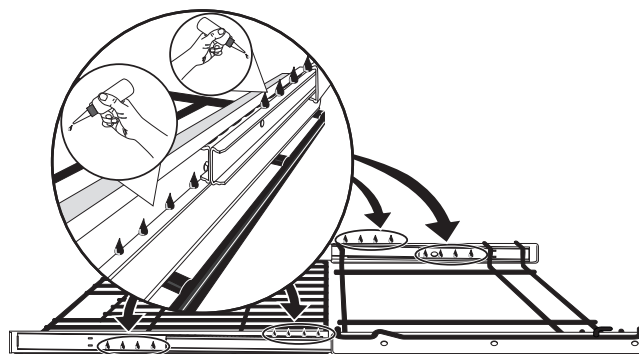

6. Extend and return the glide rack several times along the tracks to distribute the lubrication.

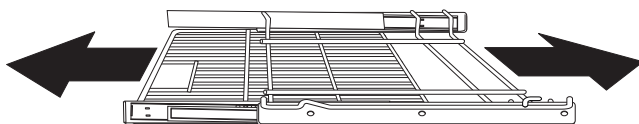

7. Apply a thin layer of cooking oil to the outer frame of the glide rack as shown below. Keeping the frame sides lightly lubricated allows the entire rack to slide easily when changing rack positions.

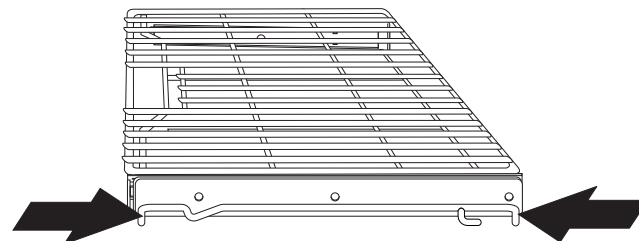

8. Replace rack in oven right-side up.

## REMOVING AND REPLACING THE OVEN DOOR

To remove the oven door:

### ⚠ CAUTION

To avoid possible injury when removing or replacing the oven door, follow the instructions below carefully and always hold the oven door with both hands positioned away from the door hinge area.

### ⚠ CAUTION

The door is heavy. For safe, temporary storage, lay the door flat with the inside of the door facing down.

### ⚠ WARNING

To prevent possible burns, do not attempt to remove the oven door until the oven has completely cooled.

1. Open oven door completely, horizontal with floor (Figure 55).
2. Pull the door hinge locks on both left and right door hinges down from the oven frame completely towards the oven door (Figure 56). A tool such as a small flat-blade screwdriver may be required.
3. Firmly grasp both sides of oven door along the door sides. Do not use the oven door handle (Figure 57).
4. Close the door until it is about ten percent open. The oven door may stop into this position just before fully closing.
5. With the oven door in the stop position, lift the oven door hinge arms over the roller pins located on each side of the oven frame (Figure 58).

To Replace Oven Door:

1. Firmly grasp both sides of oven door along the door sides. Do not use the oven door handle (Figure 57).
2. Holding the oven door at the same angle as the removal position, seat the hook of the hinge arm over the roller pins located on each side of the oven door frame (Figure 58). The hook of the hinge arms must be fully seated onto the roller pins.
3. Fully open the oven door, horizontal with floor (Figure 55).
4. Push the door hinge locks up towards and into the oven frame on both left and right oven door hinges to the locked position; then, close the oven door (Figure 56).

### IMPORTANT!

Special Door Care Instructions - Most oven doors contain glass that can break. Do not close the oven door until all the oven racks are fully in place. Do not hit the glass with pots, pans, or any other object. Scratching, hitting, jarring, or stressing the glass may weaken its structure causing an increased risk of breakage at a later time.

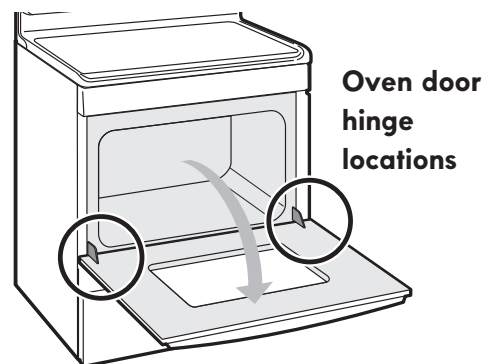

Figure 55: Door hinge location

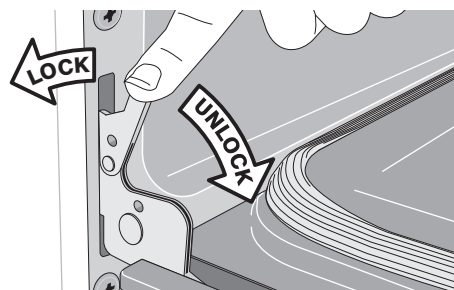

Figure 56: Door hinge locks

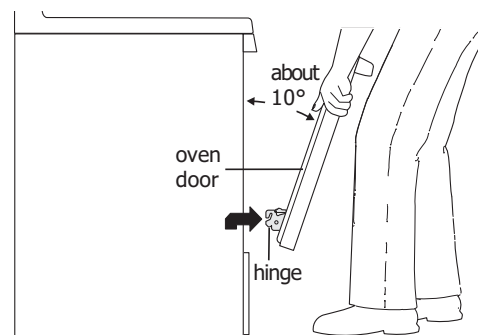

Figure 57: Holding door for removal

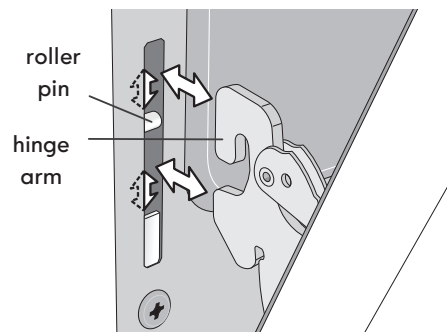

Figure 58: Location of hinge arm and roller pin

### Replacing the Dual Left/Right Corner Oven Lights

The interior oven lights are located at the rear of the oven cavity and are covered with a glass shield. The glass shield must be in place whenever the oven is in use (Figure 59).

**To replace the oven interior light bulb:**

**CAUTION**

Be sure the oven is unplugged and all parts are cool before replacing oven light. Wear a leather-faced glove for protection against possible broken glass.

1. Turn electrical power off at the main source.
2. Remove interior oven light shield by turning a quarter turn counter-clockwise.
3. Replace bulb with a new T-4 type Halogen 25 watt appliance bulb.



Do not allow your fingers to touch the new bulb when replacing. This will shorten the life of the bulb. Use a paper towel or cotton glove while handling the new bulb when installing.

4. Replace glass oven light shield by rotating clockwise.
5. Turn power back on again at the main source (or plug the appliance back in).
6. Be sure to reset the time of day on the clock.

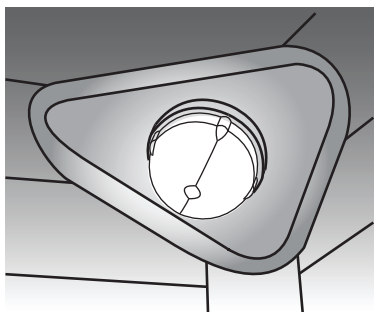

Figure 59: Wall oven Halogen light

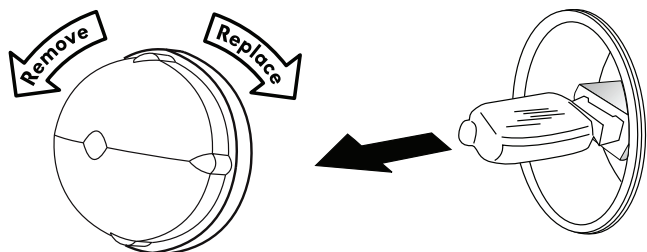

Figure 60: Replacing the oven Halogen light

### Aluminum Foil and Oven Liners

**WARNING**

Never cover any slots, holes, or passages in the oven bottom or cover an entire oven rack with materials such as aluminum foil. Doing so blocks air flow through the oven and may cause carbon monoxide poisoning. Aluminum foil linings may trap heat, causing a fire hazard.

**WARNING**

Protective Liners — Do not use aluminum foil to line the oven bottom. Only use aluminum foil as recommended in this manual. Improper installation of these liners may result in risk of electric shock, or fire.

- Aluminum foil - Use of aluminum foil on a hot cooktop can damage the cooktop. Do not use thin aluminum cooking utensils or allow aluminum foil to touch the surface burners under any circumstances.
- Aluminum utensils - The melting point of aluminum is much lower than that of other metals. Care must be taken when aluminum pots or pans are used on the cooktop. If aluminum pans are allowed to boil dry when using the cooktop, the utensil will be damaged or destroyed



Figure 61: Do not use commercial cleaners

# BEFORE YOU CALL





## SOLUTIONS TO COMMON PROBLEMS

### Oven Baking

For best baking results, heat the oven before baking cookies, breads, cakes, pies, or pastries, etc. There is no need to preheat the oven for roasting meat or baking casseroles.

The baking times and temperatures needed to bake a product may vary slightly from your previously owned appliance.

### Baking Problems and Solutions

Baking Problems	Causes	Corrections
Cookies and biscuits burn on the bottom. 	<ul style="list-style-type: none"> <li>• Cookies and biscuits put into oven before the preheating time is completed.</li> <li>• Oven rack is overcrowded or rack position too low.</li> <li>• Dark pans absorb heat too fast.</li> </ul>	<ul style="list-style-type: none"> <li>• Allow oven to preheat to desired temperature before placing food in oven.</li> <li>• Choose pan sizes that will permit 2" to 4" of air space (5.1 cm to 10.2 cm) on all sides when placed in the oven.</li> <li>• Use a medium weight baking sheet.</li> </ul>
Cakes too dark on top or bottom 	<ul style="list-style-type: none"> <li>• Cakes put in oven before preheating time is completed.</li> <li>• Rack position too high or too low.</li> <li>• Oven too hot.</li> </ul>	<ul style="list-style-type: none"> <li>• Allow oven to preheat to the selected temperature before placing food in the oven.</li> <li>• Use proper rack position for baking needs.</li> <li>• Set oven temperature 25°F (14°C) lower than recommended.</li> </ul>
Cakes not done in center 	<ul style="list-style-type: none"> <li>• Oven too hot.</li> <li>• Incorrect pan size.</li> <li>• Pan not centered in oven.</li> </ul>	<ul style="list-style-type: none"> <li>• Set oven temperature 25°F (14°C) lower than recommended.</li> <li>• Use pan size suggested in recipe.</li> <li>• Use proper rack position and place pan so there is 5.1 cm to 10.2 cm (2" to 4") of space on all sides of pan.</li> </ul>
Cakes not level. 	<ul style="list-style-type: none"> <li>• Oven not level.</li> <li>• Pan too close to oven wall or rack overcrowded.</li> <li>• Pan warped.</li> <li>• Oven light left on during baking</li> </ul>	<ul style="list-style-type: none"> <li>• Place a marked glass measuring cup filled with water on the center of the oven rack. If the water level is uneven, refer to the installation instructions for leveling the oven.</li> <li>• Be sure to allow 5.1 cm to 10.2 cm (2" to 4") of clearance on all sides of each pan in the oven.</li> <li>• Do not use pans that are dented or warped.</li> <li>• Do not leave oven light on while baking.</li> </ul>
Foods not done when baking time is over. 	<ul style="list-style-type: none"> <li>• Oven too cool.</li> <li>• Oven overcrowded.</li> <li>• Oven door opened too frequently.</li> </ul>	<ul style="list-style-type: none"> <li>• Set oven temperature 25°F (14°C) higher than suggested and bake for the recommended time.</li> <li>• Be sure to remove all pans from the oven except the ones to be used for baking.</li> <li>• Open oven door only after shortest recommended baking time.</li> </ul>

---

## Solutions to Common Problems

Before you call for service, review the following list. It may save you time and expense. Possible solutions are provided with the problem listed:

Problem	Solution
Poor baking results	<ul style="list-style-type: none"> <li>Many factors effect baking results. Use proper oven rack position. Center food in the oven and space pans to allow air to circulate. Preheat oven to the set temperature before placing food in the oven. Bakeware may be too lightweight or warped. Use heavier quality bakeware so foods being prepared may bake more evenly. Try adjusting the recipe's recommended temperature or baking time. See <a href="#">"Oven Temperature"</a> on <a href="#">page 41</a> if you feel the oven is too hot or cold.</li> </ul>
Appliance does not operate.	<ul style="list-style-type: none"> <li>Make sure power cord is plugged properly into outlet.</li> <li>Be sure regulator gas valve is turned to ON. See installation instructions.</li> <li>The time of day is not set. The oven clock must first be set in order to operate the oven.</li> <li>Be sure oven controls are set properly. See <a href="#">"Setting the Clock-Time of Day"</a> on <a href="#">page 19</a> and review instructions for the desired baking function in this user's guide.</li> <li>Service wiring is not complete. Contact your dealer, installing agent, or authorized servicer.</li> <li>Power outage. Check house lights to be sure. Call your local electric company.</li> <li>Short in cord/plug. Contact your dealer, installing agent, or authorized servicer to replace cord/plug.</li> <li>House fuse has blown or circuit breaker has tripped immediately following installation. House fuse may not be fully engaged. Check fuse and screw or engage circuit breaker securely.</li> </ul>
Oven light does not work.	<ul style="list-style-type: none"> <li>Be sure the oven light is secure in the socket. See <a href="#">"Replacing the Dual Left/Right Corner Oven Lights"</a> on <a href="#">page 53</a>.</li> </ul>
Flames inside oven or smoking from oven vent.	<ul style="list-style-type: none"> <li>Excessive spills in oven. Grease or food spilled onto oven bottom or oven cavity. Wipe up excessive spills before starting oven. If flames or excessive smoke are present when using broil, see <a href="#">"Broil"</a> on <a href="#">page 25</a>.</li> </ul>
Self clean does not work.	<ul style="list-style-type: none"> <li>Oven control not set properly. Make sure the oven door is closed. Make sure you have removed the oven racks and the oven rack supports from the oven. Review <a href="#">"Self Clean"</a> on <a href="#">page 45</a>.</li> </ul>
Oven racks do not slide easily.	<ul style="list-style-type: none"> <li>This appliance comes with lubricated porcelain oven racks, which can remain in the oven during the self-clean cycle. Do not clean this vegetable oil lubrication off the racks. It is important that the sides of the oven racks always have a light coating of vegetable oil. To maintain optimal rack performance, re-apply a thin layer of vegetable oil to the sides of the rack after every self-clean cycle or when the rack becomes difficult to slide.</li> </ul>
Glide racks do not glide smoothly.	<ul style="list-style-type: none"> <li>Glide racks need lubrication. For instructions on how to care for your glide racks, see <a href="#">"Caring for Your Glide Racks"</a> on <a href="#">page 51</a>.</li> </ul>
Oven smokes excessively when broiling.	<ul style="list-style-type: none"> <li>Incorrect setting. Follow broiling instructions in the <a href="#">"Broil"</a> on <a href="#">page 25</a>.</li> <li>Meat too close to the broil element. Reposition broil rack to provide proper clearance between the meat and broil element. Remove excess fat from meat. Cut remaining fatty edges to prevent curling, but do not cut into the lean.</li> <li>Grid on broiler pan wrong side up. Grease does not drain into broiler pan. Always place the grid on the broiler pan with the ribs up and the slots down to allow grease to drip into the pan.</li> <li>Broiler pan used without grid or grid cover with aluminum foil. Do not use the broiler pan without the grid or cover the grid with aluminum foil.</li> <li>Oven needs to be cleared. Grease build up on oven surfaces. Regular cleaning is necessary when broiling frequently. Grease or food splatters will cause excessive smoking.</li> </ul>

---

Oven control panel chimes and displays an F code error.	<ul style="list-style-type: none"> <li>Oven control has detected a fault or error condition. Press <b>STOP</b> to clear the error code. Try bake or broil function. If the F code error repeats, turn off power to appliance, wait 5 minutes and then repower appliance. Set clock with correct time of day. Try bake or broil function again. If fault recurs, press <b>STOP</b> to clear.</li> </ul>
Soil not completely removed after self clean.	<ul style="list-style-type: none"> <li>Self clean was interrupted. Review <a href="#">“Self Clean”</a> on page 45.</li> <li>Excessive spills on oven bottom. Clean before starting self clean.</li> <li>Failure to clean soil from the oven frame, the door liner outside the oven door gasket, and the small area at the front center of the oven bottom. These areas are not in the self cleaning area, but they get hot enough to burn on residue. Clean these areas before starting the self clean cycle. Burned-on residue can be cleaned with a stiff nylon brush and water or a nylon scrubber. Be careful not to damage the oven gasket.</li> </ul>
Appliance is not level.	<ul style="list-style-type: none"> <li>Poor installation. Place oven rack in center of oven. Place a level on the oven rack. Adjust leveling leg at base of appliance until the oven rack is level.</li> <li>Kitchen cabinet alignment may make oven appear not level. Be sure cabinets are square and have sufficient room for appliance clearance.</li> <li>Cabinets not square or are built in too tightly. Contact builder or installer to make appliance accessible.</li> </ul>
Fan noise occurring after the oven is turned off.	<ul style="list-style-type: none"> <li>Some models are equipped with a cooling fan that runs during the cooking process to cool internal electronic components. It is normal for this fan to continue to run for an extended period of time, even when the oven is off.</li> </ul>
Surface burner flame is too high.	<ul style="list-style-type: none"> <li>Surface control knob is set too high. Adjust to lower flame setting. Burner caps are not seated properly. Check that all surface burner caps are level and seated correctly on surface burner heads. See <a href="#">“Cleaning Surface Burner Heads”</a> on page 50.</li> <li>Incorrect L.P. conversion. Refer to L.P. conversion kit instructions to correct.</li> </ul>
Surface burners do not ignite.	<ul style="list-style-type: none"> <li>Surface control knob was not completely turned to LITE. Push in and turn the surface control knob to LITE until burner ignites and then turn control knob to desired flame size.</li> <li>Burner ports are clogged. With the burner OFF, use a small-gauge wire or needle to burner head slots and ignition ports. See <a href="#">“Cleaning Surface Burner Heads”</a> on page 50.</li> <li>Range power cord is disconnected from outlet (electric ignition models only). Be sure power cord is securely plugged into the power outlet.</li> <li>Electrical power outage. Burners may be lit manually. See <a href="#">“Setting Surface Controls”</a> on page 12.</li> <li>Be sure the gas supply to the range is turned on.</li> </ul>
Surface burner flame uneven or only part way around burner cap.	<ul style="list-style-type: none"> <li>Burner slots or ports are clogged. With the surface burner OFF, clean ports with a small-gauge wire or needle. Also, moisture is present after cleaning. Lightly fan the flame and allow burner to operate until flame is full.</li> <li>Burner caps are not seated properly. Check that all burner caps are level and seated correctly on burner heads. See <a href="#">“Cleaning Surface Burner Heads”</a> on page 50.</li> </ul>
Surface burner flame is orange.	<ul style="list-style-type: none"> <li>Dust particles in main gas line. Allow the burner to operate a few minutes until flame turns blue. In coastal areas, a slightly orange flame is unavoidable due to salt content in air.</li> <li>Incorrect L.P. conversion. Refer to L.P. conversion kit instructions to correct.</li> </ul>
Convection fan does not rotate	<ul style="list-style-type: none"> <li>Oven door is open. Convection fan will turn off if oven door is opened when convection is active. Close oven door.</li> </ul>
“d-O” is displayed	<ul style="list-style-type: none"> <li>The door was left open and control set for self-cleaning cycle. Close the door and press <b>STOP</b>.</li> </ul>
Cannot move appliance easily. Appliance must be accessible for service.	<ul style="list-style-type: none"> <li>Cabinets not square or are built in too tightly. Contact builder or installer to make appliance accessible.</li> <li>Carpet interferes with appliance. Provide sufficient space so appliance can be lifted over carpet.</li> <li>Gas line is hard-plumbed. Have a flexible CSA International approved metal appliance connector installed.</li> </ul>



# WARRANTY

Your appliance is covered by a one year limited warranty. For one year from your original date of purchase, Electrolux will repair or replace any parts of this appliance that prove to be defective in materials or workmanship when such appliance is installed, used, and maintained in accordance with the provided instructions. In addition, the glass cooktop or radiant surface element of your appliance (excluding built-in and free-standing range appliances) is covered by a two through five year limited warranty. During the 2nd through 5th years from your original date of purchase, Electrolux will provide a replacement glass cooktop or radiant surface element for your appliance which has proven to be defective in materials or workmanship when such appliance is installed, used, and maintained in accordance with the provided instructions.

## Exclusions

This warranty does not cover the following:

1. Products with original serial numbers that have been removed, altered or cannot be readily determined.
2. Product that has been transferred from its original owner to another party or removed outside the USA or Canada.
3. Rust on the interior or exterior of the unit.
4. Products purchased "as-is" are not covered by this warranty.
5. Products used in a commercial setting.
6. Service calls which do not involve malfunction or defects in materials or workmanship, or for appliances not in ordinary household use or used other than in accordance with the provided instructions.
7. Service calls to correct the installation of your appliance or to instruct you how to use your appliance.
8. Expenses for making the appliance accessible for servicing, such as removal of trim, cupboards, shelves, etc., which are not a part of the appliance when it is shipped from the factory.
9. Service calls to repair or replace appliance light bulbs, air filters, water filters, other consumables, or knobs, handles, or other cosmetic parts.
10. Labor or in-home service costs during the additional limited warranty periods beyond the first year from your original date of purchase.
11. Pickup and delivery costs; your appliance is designed to be repaired in the home.
12. Surcharges including, but not limited to, any after hour, weekend, or holiday service calls, tolls, ferry trip charges, or mileage expense for service calls to remote areas, including the state of Alaska.
13. Damages to the finish of appliance or home incurred during transportation or installation, including but not limited to floors, cabinets, walls, etc.
14. Damages caused by: services performed by unauthorized service companies; use of parts other than genuine Electrolux parts or parts obtained from persons other than authorized service companies; or external causes such as abuse, misuse, inadequate power supply, accidents, fires, or acts of God.

## DISCLAIMER OF IMPLIED WARRANTIES; LIMITATION OF REMEDIES

CUSTOMER'S SOLE AND EXCLUSIVE REMEDY UNDER THIS LIMITED WARRANTY SHALL BE REPAIR OR REPLACEMENT AS PROVIDED HEREIN. **CLAIMS BASED ON IMPLIED WARRANTIES, INCLUDING WARRANTIES OF MERCHANTABILITY OR FITNESS FOR A PARTICULAR PURPOSE, ARE LIMITED TO ONE YEAR OR THE SHORTEST PERIOD ALLOWED BY LAW, BUT NOT LESS THAN ONE YEAR.** ELECTROLUX SHALL NOT BE LIABLE FOR CONSEQUENTIAL OR INCIDENTAL DAMAGES SUCH AS PROPERTY DAMAGE AND INCIDENTAL EXPENSES RESULTING FROM ANY BREACH OF THIS WRITTEN LIMITED WARRANTY OR ANY IMPLIED WARRANTY. SOME STATES AND PROVINCES DO NOT ALLOW THE EXCLUSION OR LIMITATION OF INCIDENTAL OR CONSEQUENTIAL DAMAGES, OR LIMITATIONS ON THE DURATION OF IMPLIED WARRANTIES, SO THESE LIMITATIONS OR EXCLUSIONS MAY NOT APPLY TO YOU. THIS WRITTEN WARRANTY GIVES YOU SPECIFIC LEGAL RIGHTS. YOU MAY ALSO HAVE OTHER RIGHTS THAT VARY FROM STATE TO STATE.

## If You Need Service

Keep your receipt, delivery slip, or some other appropriate payment record to establish the warranty period should service be required. If service is performed, it is in your best interest to obtain and keep all receipts. Service under this warranty must be obtained by contacting Electrolux at the addresses or phone numbers below. This warranty only applies in the USA, Puerto Rico and Canada. In the USA and Puerto Rico, your appliance is warranted by Electrolux Major Appliances North America, a division of Electrolux Home Products, Inc. In Canada, your appliance is warranted by Electrolux Canada Corp. Electrolux authorizes no person to change or add to any obligations under this warranty. Obligations for service and parts under this warranty must be performed by Electrolux or an authorized service company. Product features or specifications as described or illustrated are subject to change without notice.

### USA

**1-877-435-3287**

Electrolux Major Appliances North America  
10200 David Taylor Drive  
Charlotte, NC 28262

### Canada

**1-800-265-8352**

Electrolux Canada Corp.  
5855 Terry Fox Way  
Mississauga, Ontario, Canada L5V 3E4





www.electrolux-store.com

