



Installation Manual

All-In-One Shower Panel System

Copyright ShopRangeHoods.com© 2016
Office: +1 (626) 321-9834
Email: support@shoprangehoods.com

Distributed by ShopRangeHoods.com
Manufactured by AKDY

FOR RESIDENTIAL USE ONLY IN US & CA
WARRANTY VOID OUTSIDE US & CA
Revised 08/16

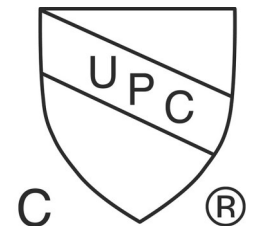

A. Direct Connect Instructions

IMPORTANT: In order to install this shower panel, simple understanding of plumbing techniques will be necessary. Please contact a professional plumber if you are unfamiliar with plumbing techniques or require assistance.

Prerequisites:

- separate cold and hot water supply lines

NOTE: This shower panel replaces any mixing valve you are currently using.

Step 1

Thank you for your purchase of an AKDY all-in-one shower panel. Begin by roughly measuring the position of the shower panel relative to your height and mark the location desired.

Step 2

Remove the shower panel and locate the position of the mounting brackets (red arrows). Take measurements and then transfer those marks to the location of the wall. Mark the center point of the location of the mounting brackets.

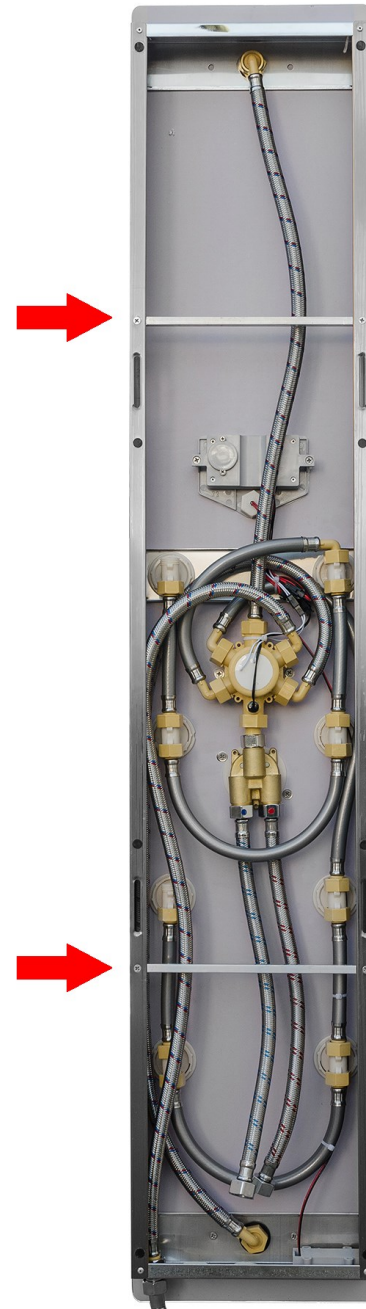

A. Direct Connect Instructions

Step 3

Using a drill, attach the wall mounting brackets with the included hardware. An extra set of hands may be required for the following steps. Lift and locate the hot and cold water lines on the shower panel (red circle).

Step 4

Connect the hot and cold water supply lines to the flexible hoses. Be sure to use the included washers. It is recommended a $\frac{3}{8}$ " right angle connection be installed to better route the flexible hoses (see diagram).

Step 5

Once connected, lift the entire shower panel and hook it to the wall using the mounting brackets. There are two types of mounting brackets used for our shower panels. Check the next page for detailed mounting instructions.

Step 6

Check if the unit is leveled. Test out all shower functions including the water temperature to finish installation.

NOTE: If your water temperature is either too hot or too cold, please check the hot and cold water lines. The connection may be reversed (cold to hot).

Step 7

Complete the installation by using silicone sealant around the perimeter of the shower panel. Your installation is now complete.

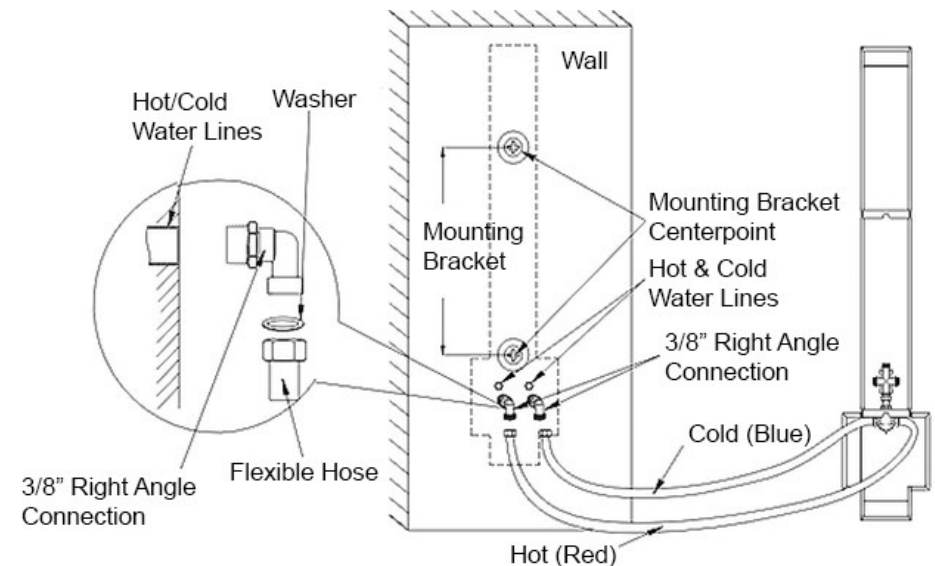
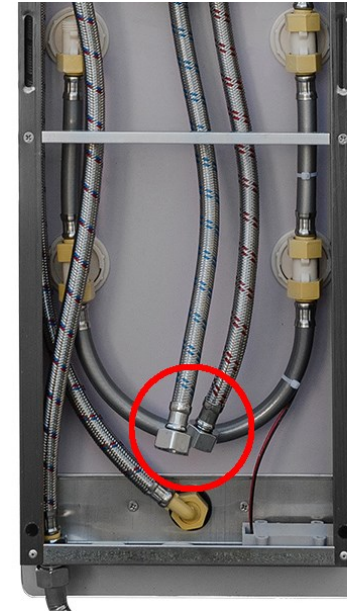

B. Easy Connect System Instructions

Step 1

Before beginning installation, ensure the shower panel has sufficient space between the showerhead and pre-existing temperature controls.

Step 2

With the water turned off, remove your showerhead and arm from the wall. Note: Standard 1/2" connections are used.

1

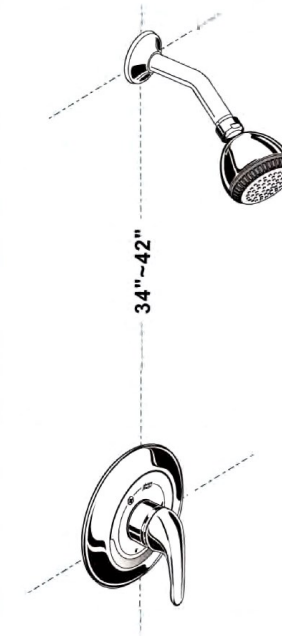

2

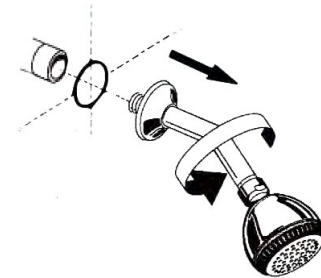

B. Easy Connect System Instructions

Step 3

Connect the included Brass Extender Joint (1/2" size) to the existing showerhead pipe outlet. Multiple sized brass extenders may be included. Choose the one appropriate for your wall thickness. Use Teflon tape for a secure seal.

Step 3a

Peel off the adhesive backing from the Base Plate Cover.

Step 3b

Adhere the Base Plate Cover to the wall. Note: Make sure the wall surface is free of dirt and residue.

Step 3c

Join the Elbow Connector and Main PVC Pipe assembly to the Brass Extender Joint by turning clockwise. Do not over tighten.

Step 3d

Install the Showerhead Connector Cover.

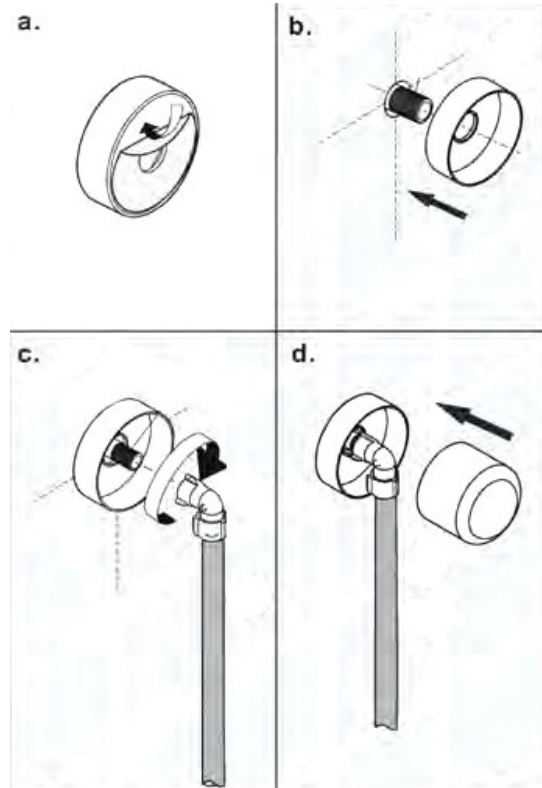
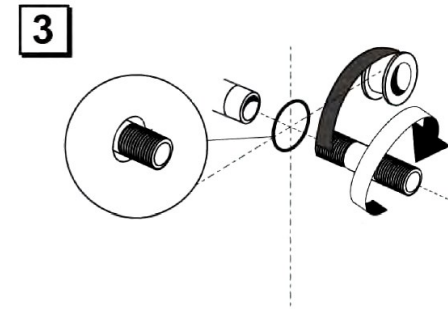

Mounting Instructions: Type A

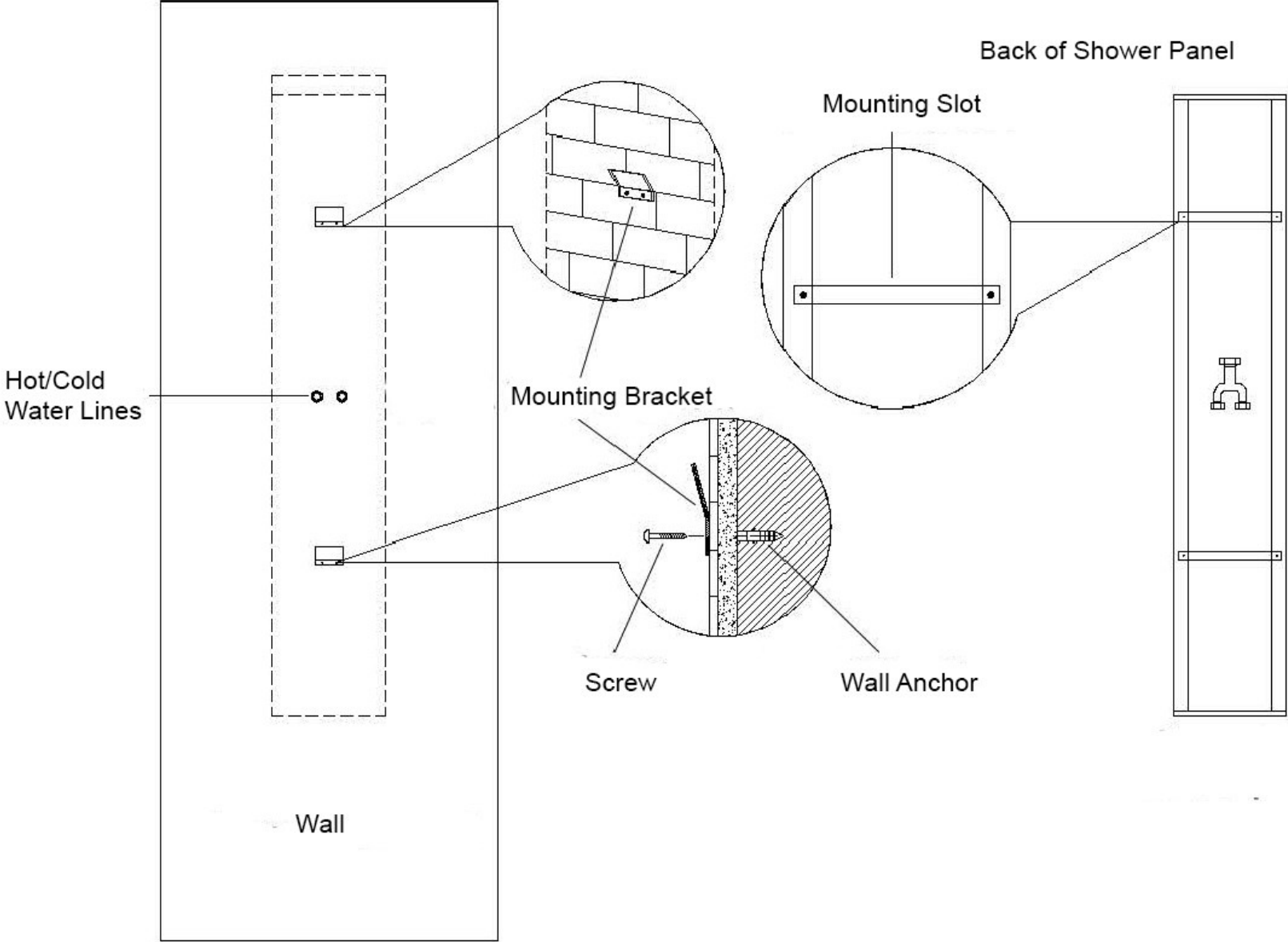

Mounting Instructions: Type B

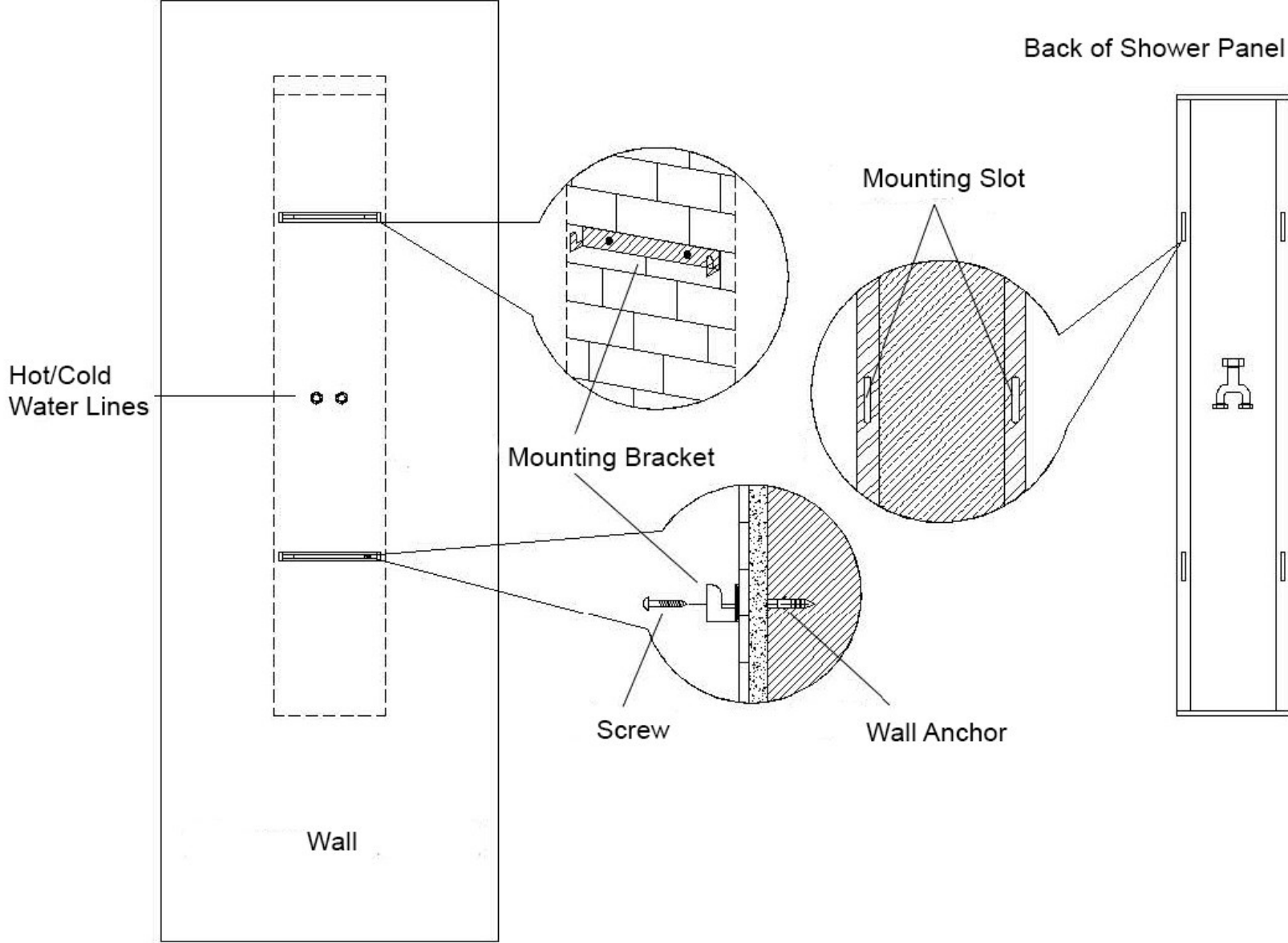

Use and Care Guide

Shower Panel Body

Acrylic or tempered glass shower panels may show water spots. A mild household cleaner will remove them.

Aluminum or stainless steel shower panels can be cleaned with a mild cleaner.

Note: Avoid abrasive cleaners or harsh scrubbing pads (acetone, Ajax, Comet, or other solvents).

Showerhead and Body Jets

Both the showerhead and body jets use non-clogging rubber nozzles that can remove calcium deposits just by rubbing your finger along them. If clog remains, please use CLR or other hard water cleaner.

Note: Avoid abrasive cleaners or harsh scrubbing pads (acetone, Ajax, Comet, or other solvents).

.

RETURNS & WARRANTY

We thank you for your purchase. If you are not satisfied with your purchase or have an issue with our product, please kindly let us know. Our full returns policy is outlined below. Carefully read over our terms before contacting us. If you have questions, our customer service team can be reached at: +1 (626) 321-9834 or support@shoprangehoods.com.

For 1-3 years from the date of purchase, when this major appliance is operated and maintained according to instructions attached to or furnished with the product, ShopRangeHoods.com will pay for Factory Specified Parts. This limited warranty is valid only in the United States or Canada and applies only when the major appliance is used in the country in which it was purchased. Outside the United States and Canada, this limited warranty is null and void. Proof of original purchase date is required to obtain service under this limited warranty.

DISCLAIMER OF IMPLIED WARRANTIES: LIMITATION OF REMEDIES

CUSTOMER'S SOLE AND EXCLUSIVE REMEDY UNDER THIS LIMITED WARRANTY SHALL BE PRODUCT REPAIR AS PROVIDED HEREIN. IMPLIED WARRANTIES, INCLUDING WARRANTIES OF MERCHANTABILITY OR FITNESS FOR A PARTICULAR PURPOSE, ARE LIMITED TO ONE YEAR OR THE SHORTEST PERIOD ALLOWED BY LAW. SHOPRANGEHOODS.COM SHALL NOT BE LIABLE FOR INCIDENTAL OR CONSEQUENTIAL DAMAGES. SOME STATES AND PROVINCES DO NOT ALLOW THE EXCLUSION OR LIMITATION OF INCIDENTAL OR CONSEQUENTIAL DAMAGES, OR LIMITATIONS ON THE DURATION OF IMPLIED WARRANTIES OF MERCHANTABILITY OR FITNESS, SO THESE EXCLUSIONS OR LIMITATIONS MAY NOT APPLY TO YOU. THIS WARRANTY GIVES YOU SPECIFIC LEGAL RIGHTS, AND YOU MAY ALSO HAVE OTHER RIGHTS WHICH VARY FROM STATE TO STATE OR PROVINCE TO PROVINCE.

MANUFACTURER'S WARRANTY

ShopRangeHoods.com provides a 3-year limited parts warranty for all range hoods, and a 1-year limited parts warranty for all bathtubs, tub fillers, kitchen sinks, kitchen sinks, shower heads, shower wands, and shower panels. Under this warranty, you (the customer), is entitled to replacement parts at no cost to repair and restore functionality if any part of the product were to fail. No labor is provided. Certain consumables that are not covered under this warranty include:

- * Lights (halogen and LEDs)
- * Carbon Filters
- * Mesh or Baffle Filters
- * Ducting

The above parts are guaranteed to last one year beginning from the date of purchase. If they fail prematurely or are defective within 1 year of purchase, ShopRangeHoods.com will replace them at no charge.

If a main unit or complete replacement has to be sent, ShopRangeHoods.com will require that the customer pay for shipping. Shipping for parts are free under the warranty period.

RETURNS, DAMAGES, MISSING PARTS

Ground Shipments – Range Hoods, Shower Heads/Wands, Sinks, Tub Fillers

We accept all returns within 30 days with return shipping to be paid by the customer if the item was:

- * deemed unsuitable
- * the wrong size
- * purchased but not used
- * an accidental purchase
- * buyer's remorse

Resolution Process for Damages or Missing Items (Ground Shipments)

- 1a. Customer provides images of damage (mandatory)
- 1b. Customer notifies us (ShopRangeHoods.com) for missing parts or items
- 2a. We send a replacement unit (discretionary)
- 2b. We send replacement parts
3. Customer is provided a new tracking number for the replacement or parts shipped via Ground shipping or Parcel

Freight Shipments – Bathtubs, Oversized Range Hoods

All bathtubs will ship via freight. Due to the large size and weight, please allow approximately 2 weeks for the item to arrive. If you have received a freight shipment, please kindly:

- * inspect for damages (ex: cracks, chips, etc.)
- * inspect for missing parts or items part of a bundle

Resolution Process for Damages or Missing Items (Freight Shipments)

- 1a. Customer provides images of damage (mandatory)
- 1b. Customer notifies us (ShopRangeHoods.com) for missing parts or items
- 2a. We send a replacement unit (discretionary)
- 2b. We send replacement parts
3. Customer is provided a new tracking number via our 3rd party LTL carrier for the replacement or parts

If the customer contacts us after the 30-day window for a return, ShopRangeHoods.com will require a 15-40% restocking fee to be applied to the return depending on the condition of the item and the number of days passed the standard 30-day window.

If shipping damage is noticeable upon arrival, please immediately reject the package, take pictures of the damages, and contact customer support for assistance.

If the item is delivered and arrived damaged, we will either send a

replacement and take back the damaged item, or send parts to repair the item depending on the severity of the damage. A full replacement will be issued only under our discretion. Under certain authorized vendors who carry our products, shipping damages that require a full replacement will require contacting the seller and not ShopRangeHoods.com.

All shipping damages must be reported within 30 days of delivery. Missing or lost items must be reported within 7 days of delivery. The customer must also notify the local authorities to obtain a police report if the tracking information shows the item as being delivered, but not received. A replacement part or unit will be shipped out only if these rules are met. After the 30-day window for damaged items or 7 days for lost and missing packages, ShopRangeHoods.com reserves the right to not ship replacement parts or complete units. No exceptions will be made and we will not be held responsible.

WARRANTY EXCLUSIONS

The included warranty is null/void and does not cover the following conditions:

1. Service calls to correct the installation of your major appliance, to instruct you on how to use your major appliance, to replace or repair house fuses, or to correct house wiring or plumbing.
2. Service calls to repair or replace appliance light bulbs, air filters or water filters. Consumable parts are excluded from warranty coverage.
3. Repairs when your major appliance is used for other than normal, single-family household use or when it is used in a manner that is contrary to published user or operator instructions and/or installation instructions.
4. Damage resulting from accident, alteration, misuse, abuse, fire, flood, acts of God, improper installation, installation not in accordance with electrical or plumbing codes, or use of consumables or cleaning products not approved by us.
5. Cosmetic damage, including scratches, dents, chips or other damage to the finish of your major appliance, unless such damage results from defects in materials or workmanship and is reported to us within 30 days from the date of purchase.
6. Any food loss due to refrigerator or freezer product failures.
7. Costs associated with the removal from your home of your major appliance for repairs. This major appliance is designed to be repaired in the home and only in-home service is covered by this warranty.
8. Repairs to parts or systems resulting from unauthorized modifications made to the appliance.
9. The removal and reinstallation of your major appliance if it is installed in an inaccessible location or is not installed in accordance with published installation instructions.
10. Major appliances with original model/serial numbers that have been removed, altered or cannot be easily determined. This warranty is void if the factory applied serial number has been altered or removed from your major appliance. The cost of repair or replacement under these excluded circumstances shall be borne by the customer.