

FRONT LOADING

DECO

COMPACT SHORT DRYER

Model 850

OWNER'S MANUAL

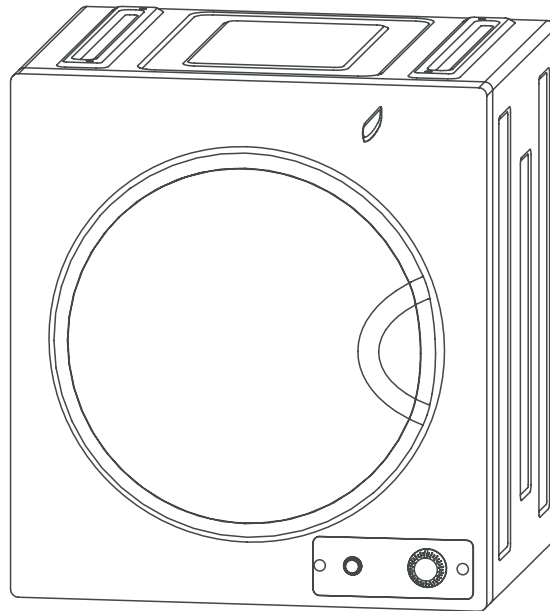

TABLE OF CONTENTS

Warranty Information	3
Parts and Features	5
This dryer can not be used upside	6
For Your Safety	7
Important Safety Instructions	8
Installation Instructions	8
Before Using Your Dryer	8
Wall Mounting Instructions	9
Leveling Legs	10
Electrical Connection	10
Control Panel	10
Operating Your Appliance	11
Temperature Control	11
Dry Mode Selector	11
Drying Time Reference	11
Sorting Fabrics	12
Fabric Care Sheet	13
Care and Maintenance	13
Cleaning Your Appliance Exterior	13
Cleaning the Filters	13
Troubleshooting Guide	14

WARRANTY INFORMATION

Your appliance is protected by this warranty under normal, personal, family or household use (1 Year), and limited commercial use (90 days), in the USA and Canada.

WARRANTY

Deco Appliances undertakes to the consumer-owner to repair or, at our option, to replace to replace any part of this product which proves to be defective in workmanship or material under normal personal, family or household use, in the USA and Canada, for a period of one year from the date of original purchase. For commercial use, the product is warranted for a period of 90 days. During this period, we will provide all labor and parts necessary to correct such defect, free of charge, if the appliance has been installed and operated in accordance with the written instructions with the appliance. Ready access to the appliance, for service, is the responsibility of the consumer-owner.

EXCLUSIONS

In no event shall Deco Appliances be liable for incidental or consequential damages or for damages resulting from external causes such as abuse, misuse, incorrect voltage or acts of God. This warranty does not cover service calls which do not involve defective workmanship or materials covered by this warranty. Accordingly, diagnosis and repair costs for a service call which does not involve defective workmanship or materials will be the responsibility of the consumer-owner.

Specifically, the following work is not covered under warranty and does not constitute warranty work:

Installation – e.g. improper hook-up or leveling or non-removal of shipping rods

Maintenance – e.g. cleaning of air and/or water filter

Damage – e.g. replacing broken door handle

Most work is covered. The defining factor is, has the machine malfunctioned (Deco Appliances is responsible) or has the customer omitted or done something to cause machine to malfunction (customer is responsible). Some States do not allow the exclusion or limitation of incidental or consequential damages, so the above limitation or exclusion may not apply to you.

WARRANTY SERVICE

This warranty is given by:

Deco Appliances
10216 Georgibelle Drive, Suite 900D
Houston, TX 77043-5249

For Service:

Call 1-800-776-3538
Email: service@appliancedesk.com
Web: www.ApplianceDesk.com
Business hours (9:00 a.m. to 5:00 p.m. weekdays).

GENERAL

Since it is responsibility of the consumer-owner to establish the warranty period by verifying the original purchase date, the Deco Appliances recommends that a receipt, delivery slip or some other appropriate payment record be kept for that purpose. Remember to send to send in your Warranty Registration Card so that a proof of your purchase exists with the Deco Appliances. You can also register online by typing the following link **www.ApplianceDesk.com**. This warranty gives you specific legal rights, and you may also have other rights which vary from State to State.

All rights reserved. Manual subject to change without notice.



Electrical Testing Laboratories

US N° [REDACTED] CANADA

The ETL Listed Mark is the legal equivalent to the UL and CSA Listed Marks

PARTS AND FEATURES

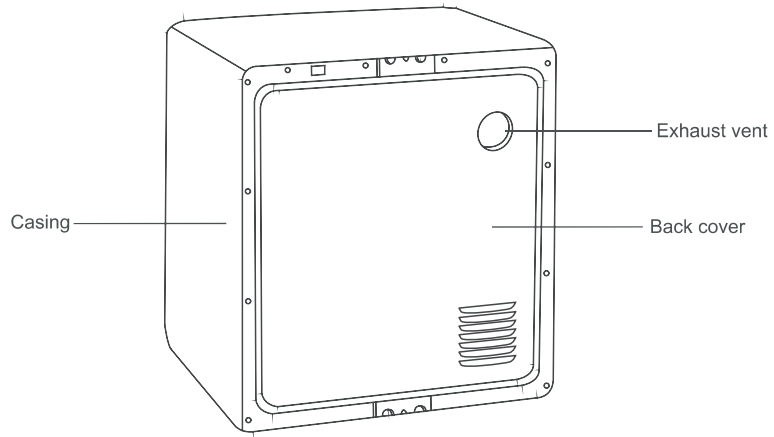
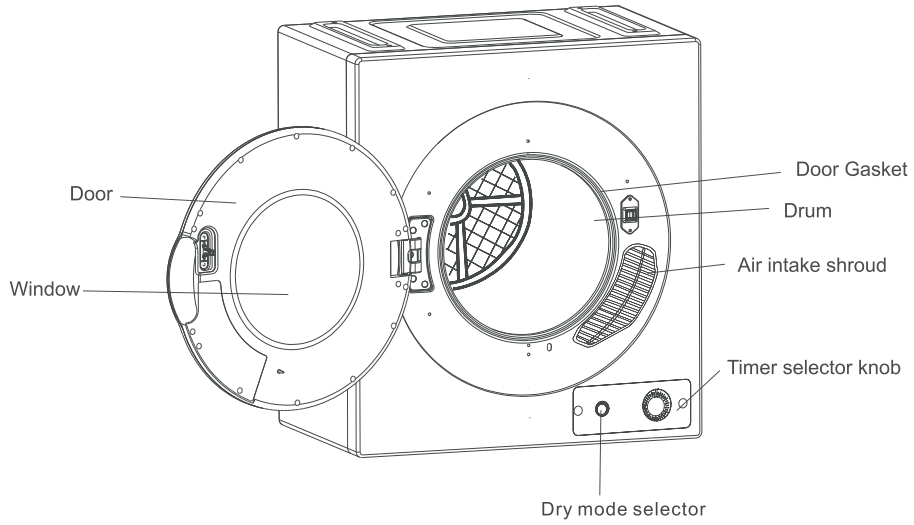



Caution, danger

This dryer can not be used upside down

WARNING

-Risk of Fire

Clothes dryer installation must be performed by a qualified installer.

Install clothes dryer according to the manufacturers instructions and local codes.

Do not install a clothes dryer with flexible plastic venting materials. If flexible metal (foil type) duct is installed, it must be of a specific type identified by the appliance manufacturer as suitable for use with clothes dryers. Flexible venting materials are known to collapse, be easily crushed, and trap lint. These conditions will obstruct clothes dryer airflow and increase the risk of fire.

To reduce the risk of severe injury or death, follow all Installation instructions.

Connect To Individual Branch Circuit.

This appliance must be grounded. In the event of malfunction or breakdown, grounding will reduce the risk of electric shock by providing a path of least resistance for electric current. This appliance is equipped with a cord having an equipment-grounding conductor and grounded in accordance with all local codes and ordinances.

WARNING

- Improper connection of the equipment-grounding conductor can result in a risk of electric shock. Check with a qualified electrician or service representative or personnel if you are in doubt as to whether the appliance is properly grounded. Do not modify the plug provided with the appliance: if it will not fit the outlet, have a proper outlet installed by a qualified electrician.

It must be placed on firm horizontal ground. Do not place the dryer on carpet as this will block the intake. There should be at least 10cm between the dryer and the walls.

Place the dryer in a dry well ventilated area. It should be positioned away from heat and direct sunlight.

Do not wash directly with water.

Do not use thinner, gasoline or alcohol.

Do not use any type of spray cleaner when cleaning the interior. If dryer drum becomes stained, clean the drum with a damp cloth.

Remove any residue before drying the next load.

Clean cabinet with mild soap and water. Do not use harsh or abrasive cleaners, this could damage the dryer.

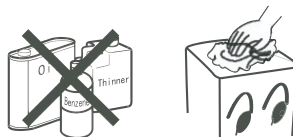

Important Safeguards

When using electrical appliances, in order to reduce the risk of fire, electric shock, and/or injury to persons, basic safety precautions should always be followed, including:

For Your Safety

Read all instructions carefully, even if you are quite familiar with the appliance.

- This appliance is not intended for use by persons (including children) with reduced physical, sensory or mental capabilities, or lack of experience and knowledge, unless they have been given supervision or instruction concerning use of the appliance by a person responsible for their safety.
- Do not allow children to play on or in the appliance. Close supervision of children is necessary when the appliance is used near children.
- **INDOOR USE ONLY** – this appliance is not intended for outdoor use.
- Do not place naked flame sources, such as candles, on the appliance.
- Do not locate the appliance or cord near heat sources such as radiators, heaters, air ducts or direct sunlight.
- Do not block any of the ventilation openings. Ensure that vents are not covered by newspapers, tablecloths, curtains, etc.
- Do not run the cord under floor coverings. Instead, arrange the cord away from traffic areas where it will not become a trip hazard.
- To disconnect the appliance, turn the appliance off, switch off the power outlet and remove the plug from the power outlet.
- Do not misuse the cord. Never carry the appliance by the cord or pull to disconnect it from the outlet. Instead, grasp the plug and pull to disconnect.
- Do not operate the appliance if it has a damaged cord or plug; after the appliance malfunctions; or has been dropped or damaged in any way. Consult the manufacturer.
- Do not attempt to repair, disassemble or modify this appliance. The warranty becomes void if not serviced or repaired by a qualified person.
- Do not reach into the appliance if the drum is moving.
- Do not place items that have been soiled with flammable liquids inside the dryer without washing them with detergent thoroughly before hand.
- Do not excessively bend, stretch, twist or bind the power cord or place heavy objects on it.
- This appliance is only to be serviced by a qualified person. There are no user-serviceable parts inside.
- Do not install in a tight fitting cabinet.
- Do not overload the tumble dryer.
- Do not dry articles that have been previously cleaned in, washed in, soaked in, or spotted with gasoline, dry-cleaning solvents, or other flammable or explosive substances, as they give off vapours that could ignite or explode.
- Before the appliance is removed from service or discarded, remove the door to the drying compartment.
- Do not install or store this appliance where it will be exposed to the weather.
- Do not tamper with controls.
- Do not repair or replace any part of the appliance or attempt any servicing unless specifically recommended in the user-maintenance instructions or in published user-repair instructions that you understand and have the skills to carry out.
- Do not use fabric softeners or products to eliminate static unless recommended by the manufacturer of the fabric softener or product.
- Do not use heat to dry articles containing foam rubber or similarly textured rubber-like materials.
- Keep area around the exhaust opening and adjacent surrounding areas free from the accumulation of lint, dust, and dirt.
- The interior of the appliance and exhaust duct should be cleaned periodically by qualified service personnel.
- Do not place items exposed to cooking oils in your dryer. Items contaminated with cooking oils may contribute to a chemical reaction that could cause a load to catch fire.
- Ensure foreign objects do not find their way into the tub of the tumble dryer.
- Clean lint screen before or after each load.

Important Safety Instructions

⚡ WARNING ⚡

To reduce the risk of fire, electrical shock, or injury when using your appliance, follow these basic precautions:

- Read all instructions before using the appliance.
- **DANGER or WARNING:** Risk of child entrapment.
- Child entrapment and suffocation are not problems of the past. Junked or abandoned appliances are still dangerous. . . even if they will “just sit in the garage a few days.”
- **Before you throw away your old appliance:** Take off the door so that children may not easily climb inside.
- Never allow children to operate, play with, or crawl inside the appliance.
- Never clean appliance parts with flammable fluids. The fumes can create a fire hazard or explosion.
- Do not place the dryer in steamy rooms or where the dryer is directly exposed to rain. Moisture may destroy the electrical insulation causing an electrical shock hazard.
- During spinning, don't put your hand in the spin basket: Because the spin basket is rotating at high speed, rotating parts may injure your hand.
- Do not store or use gasoline or any other flammable vapors and liquids in the vicinity of this or any other appliance. The fumes can create a fire hazard or explosion.

-Save these instructions-

INSTALLATION INSTRUCTIONS

➤ **Before Using Your Appliance**

- Remove the exterior and interior packing.
- Check to be sure you have all of the following parts:
- Instruction Manual
- Allow at least 5 inches of space between the sides of the appliance.
- Put your laundry into the dryer evenly. Uneven laundry may cause noise or vibration.
- Before drying, check all pockets. If nails or pins remain in pockets, they may damage the dryer or clothes.
- Never splash water on the control panel.
- Plug the dryer into an exclusive properly installed-grounded wall outlet. Do not under any circumstances cut or remove the third (ground) prong from the power cord.

➤ **Selecting a Location**

Before you install the dryer, select a location with the following characteristics:

- A hard level surface (if the surface is uneven, see “Adjusting the Leveling Legs”).
- If you are going to wall mount your dryer using the wall mounting kit included (see “Wall Mounting Instructions”)
- Away from direct sunlight. Direct sunlight may affect the acrylic coating, plastic and electrical components.
- Adequate ventilation
- Room temperature that will not fall below 32°F/0°C.
- Away from sources of heat such as coal or gas. Make sure that the dryer does not stand on its power cord. Ventilation openings must not be obstructed by carpeting when the dryer is installed on a carpeted floor.







➤ Wall Mounting Instructions

Determine dryer position on wall and mark required bracket position. This dryer is not suitable to be directly placed on top of a washing machine. Instead use rear stacking kit or dryer stack rack.

* A minimum 50mm is needed between the top of the dryer and the ceiling for ease of installation.

* If mounting above a washing machine, allow sufficient room to open the lid of the washer.

Tools Required		
Tools and parts required for Plaster and or Wood Installation	Drill & Drill Bit	1
	Phillips Head Screw Driver	1
	Wood screws 50mm long	4

Wall Mounting Kit Includes the following			
Description	Wall Hanging Bracket		2
	Wall Hanging Hook		2
	Exhaust connector		1
	12mm long Screws		4
	16mm long Screws		3
	25mm long Screws		4
	Exhaust Pipe		1

- Fix the wall hanging brackets (2 supplied) to the wall securely (e.g. into the stud). Fit a timber slat between the studs to mount the brackets onto if the stud position is too wide.

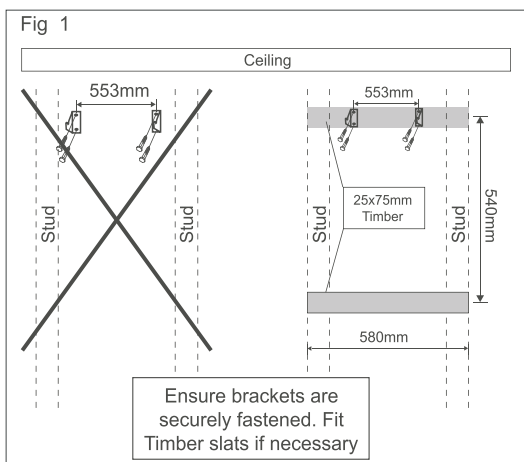

- To install the hanging hook to timber, start at Fig 2.

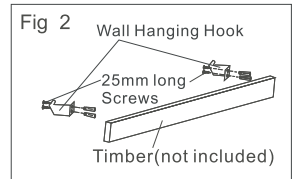

- Align hanging hooks and fasten screws tightly.

- Install the L-exhaust hose as shown in illustration (Fig. 3).

Install the Hose Connector as shown in illustration (Fig. 3). (Installation hardware included)

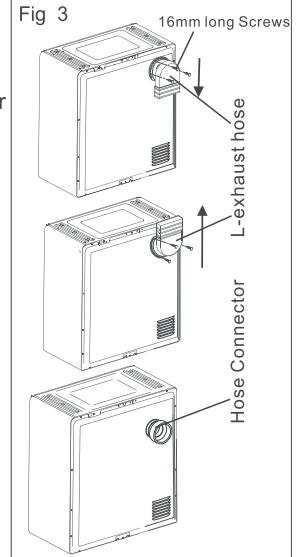

- Using 3×16mm screws (provided) to fix the outlet in place firmly.

- Using 4×12mm screws (provided) to fix the 2 Wall Hanging Bracket as per Fig 4.

- With assistance, mount dryer on wall bracket. See Fig 5.

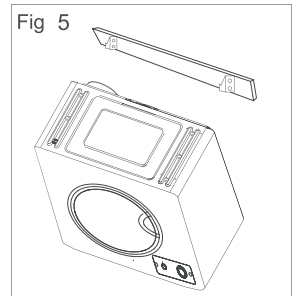
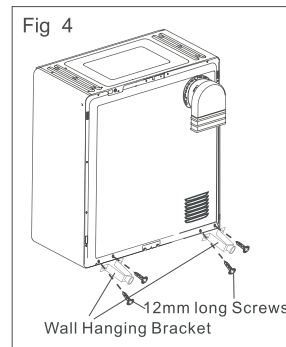

The appliance shall not be exhausted into a chimney, a wall, a ceiling, an attic, a crawl space, or a concealed space of a building.

Only rigid or flexible metal duct shall be used for exhausting.

In Canada, that only those foil-type flexible ducts, if any, specifically identified for use with the appliance by the manufacturer shall be used. In the United States, that only those foil-type flexible ducts, if any, specifically identified for use with the appliance by the manufacturer and that comply with the outline for Clothes Dryer Transition Duct, Subject 2158A, shall be used.

In Canada, that the exhaust duct shall be 102 mm in diameter. In the United States, the required exhaust duct diameter.

That the total length of flexible metal duct shall not exceed 2.4 m.

That the duct shall not assembled with screws or other fastening means that extend into the duct and catch lint.

➤ Adjusting the leveling legs

Your dryer is shipped with the legs in the bag containing your user's guide. To install and adjust the leveling legs see the illustration to the right.

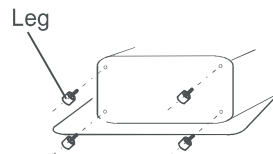

If the floor is uneven adjust the legs (do not insert pieces of wood, or any other objects under the legs)

- Adjust the height level of the legs accordingly.

Place the dryer on a sturdy flat surface.

If the dryer is placed on an uneven or weak surface, noise or vibration will occur. (Allowable is 1°)

➤ Electrical Connection

⚡ Warning ⚡

Improper use of the grounded plug can result in the risk of electrical shock. If the power cord is damaged, have it replaced by an authorized service center.

This appliance should be properly grounded for your safety. The power cord of this appliance is equipped with a three-prong plug which mates with standard three prong wall outlets to minimize the possibility of electrical shock.

Do not under any circumstances cut or remove the third ground prong from the power cord supplied.

Use of extension cord is not recommended.

This appliance requires a standard 115/120-volt, 60Hz electrical outlet with three-prong ground. The cord should be secured behind the appliance and not left exposed or dangling to prevent accidental injury.

➤ CONTROL PANEL

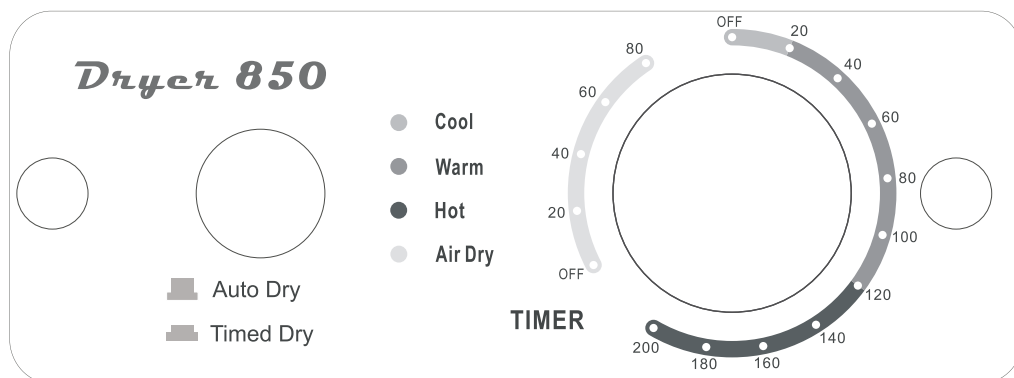

➤ OPERATING INSTRUCTIONS

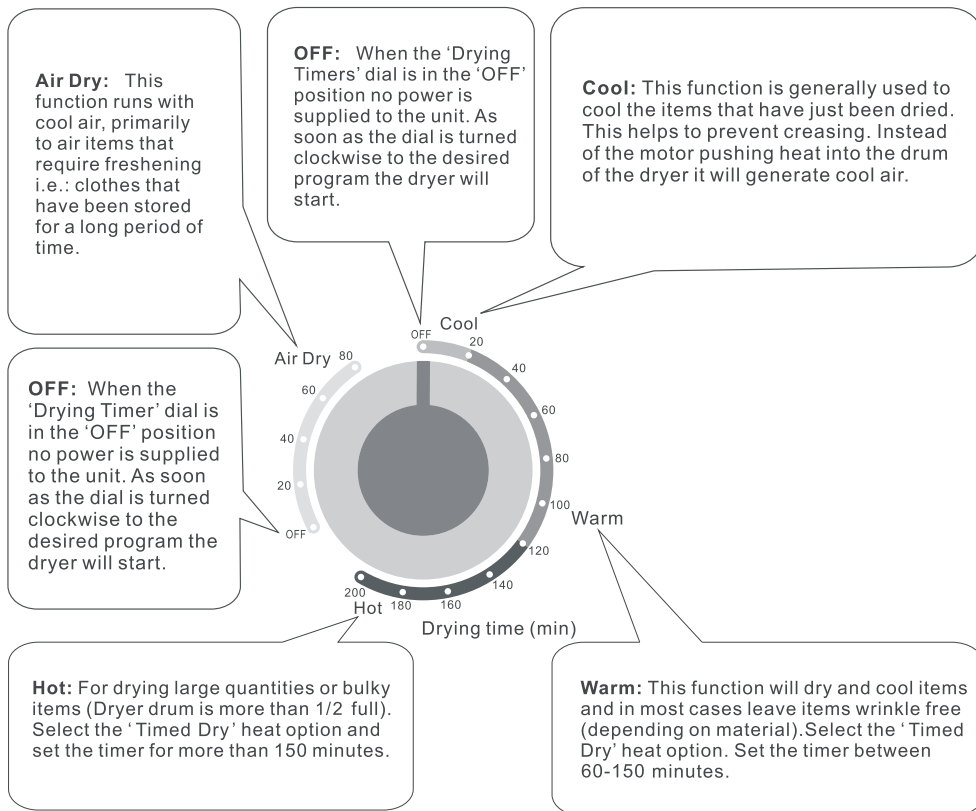

➤ DRY MODE SELECTOR

This unit is designed with an automatic moisture sensor to monitor the moisture level of the clothes for optimistic performance. It provides you both **Auto Dry** and **Timed Dry** modes for your best drying performance.

Auto Dry Mode:

When the selector button is up, unit works at automatic drying mode. Please set the timer to 200 minutes and unit will start drying process till the moisture reaches setting degree, (unit will cut off the heating element inside and terminate the drying automatically), but unit will continue the wrinkle guard process till the timer runs to "OFF" position.

Note: For heavy items like jeans, blankets, covers, towels, etc, recommended mode is timed dry.

Timed Dry Mode:

When the selector button is pressed down, unit will work under timer controlled mode. Set the timer with the following references:

➤ DRYING TIME REFERENCE

**** LOAD WEIGHTS AND RESPECTIVE DRYING TIMES ARE APPROXIMATE ****

Drying Capacity	Drying Times	
	High Heat	Low Heat
Approx. 4.4 lbs	30 Minutes	55 Minutes
Approx. 6.6 lbs	60 Minutes	110 Minutes
Approx. 8.8 lbs	120 Minutes	
Approx. 13.2 lbs	200 Minutes	

Sorting Fabrics

For the best drying results, clothes should be sorted properly. Separate the lint shedders (chenille and terry cloth) from the lint collectors (synthetics, flannel and fabrics with a nap, such as velveteen and corduroy). Separate non-colorfast from light colored items, heavy fabrics from light weight fabrics and permanent press from heavy, bulky items.

Do not tumble dry

Read all permanent care labels carefully. If a garment's care label says "Drip Dry", Line Dry or "Dry Flat", do not dry in the dryer. Certain materials will melt or become dangerously flammable if heated, while others may lose their shape. Other items that should not be tumble dried are:

- Items that have been dry-cleaned at home.
- Wool (unless the garment's manufacturer recommends it)
- Fiberglass
- Laminated or rubber coated items
- Vinyl or plastic
- Do not use fabric softeners or products to eliminate static unless recommended by manufacturer of the fabric softener or product.

WARNING:

To reduce the risk of fire, electric shock, or injury to persons, read the IMPORTANT SAFETY INSTRUCTIONS before operating this appliance.

Drying Time

Drying time depends on many factors, such as the amount of washing, how damp it is, the type of fabrics, rated power of the machine and the temperature of the room. It also, of course, depends on how dry you want the washing when you take it out of the machine.

Shrinkage

Knitted fabrics in particular are liable to shrink. Do not use the extra dry program for these materials, and always stretch them out directly after drying.

Dryer Added Fabric Softeners

Because some dryer added fabric softeners may cause damage to automatic dryers, use only ones that the manufacturers give a written assurance that their softeners can safely be used in your dryer.

Single Items

Use the timed program when there is only one item to be dried. This is because the automatic program may turn off the heating too early, so that the item is not properly dried.

























If The Washing Is Not Dry After Tumble-Drying

When using the automatic programs, it can happen that not all of the washing is properly dry. This may be due to such reasons as very heavy fabrics or thick seams. To dry these items, give a further 10 minutes or so in the timed program. Also do not overload the dryer. If the dryer is overloaded, its efficiency is lessened and clothes may not dry evenly.

Do not over-dry

When using the timed program, it is possible to over-dry fabrics, if too long a time has been set. This can cause the fabrics to wrinkle, shrink or feel harsh. Synthetic materials can also become charged with static electricity.

Fabric Care Chart

	Resistant material		Can be ironed at 212°F/100°C max
	Delicate fabric		Do not iron
	Item may be washed at 203°F/95°C		Can be dry cleaned using any solvent
	Item may be washed at 140°F/60°C		Dry clean with perchloride, lighter fuel, pure alcohol or R113 only
	Item may be washed at 104°F/40°C		Dry clean with aviation fuel, pure alcohol or R113 only
	Item may be washed at 86°F/30°C		Do not dry clean
	Item may be hand washed		Dry flat
	Dry clean only		Can be hung to dry
	Can be bleached in cold water		Dry on clothes hanger
	Do not bleach		Tumble dry, normal heat
	Can be ironed at 392°F/200°C max		Tumble dry, reduced heat
	Can be ironed at 302°F/150°C max		Do not tumble dry

CARE AND MAINTENANCE



➤ **Cleaning the Exterior**

- Wipe the dryer surfaces, including the control panel, with a soft cloth and non-abrasive household detergents.
- Use a soft cloth to dry the surfaces.
- Do not pour water on the dryer.

➤ **Cleaning the Filters**

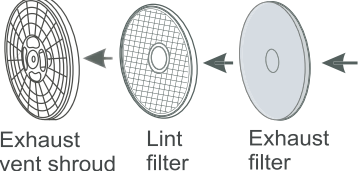
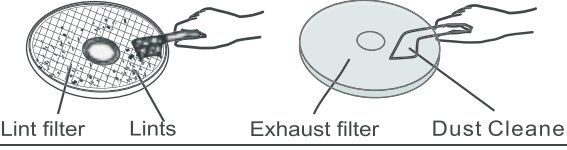
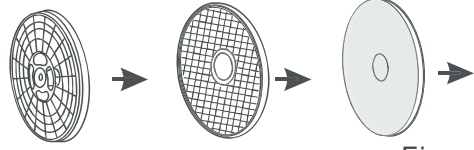
Unplug the power cord prior to any cleaning.

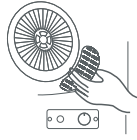
Cleaning the Lint Filter:	
a)	<p>Removing the Lint Filters: Remove by pulling outward using the four (4) grip holes in the filter assembly.</p> <p>ALL FILTERS MUST BE IN PLACE WHEN DRYING FILTERS MUST BE CLEANED BEFORE AND AFTER EACH USE.</p>
b)	<p>The filter assembly consists of three (3) parts (See illustration) a) Exhaust Vent Shroud b) Lint Filter c) Exhaust Filter</p> 
c)	<p>Separate each of the above parts and clean the individual pieces using a SOFT brush or vacuum cleaner. DO NOT damage the filters</p> 
d)	<p>Re-install the filter assembly Reassemble the filter assembly in order Exhaust Filter - Lint Filter - Exhaust Shroud Align the entire assembly with the recessed position in the back of the drum and press firmly until the entire assembly is secure.</p>  <p style="text-align: right;">Figure 3</p>

Cleaning the Air Intake Filter	
a)	<p>Removing the Air Intake Filter: Remove by pulling outward holding the filter housing by the top and bottom.</p> 
b)	<p>Remove the filter inside the housing and clean using a SOFT brush or vacuum cleaner.</p>  <p style="text-align: center;">Air intake filter</p>
c)	<p>Replace the filter housing by pushing upwards with your thumb until the latch is secure.</p>

PROBLEMS WITH YOUR DRYER?

You can solve many common appliance problems easily, saving you the cost of a possible service call. Try the suggestions below to see if you can solve the problem before calling the servicer.

TROUBLESHOOTING GUIDE

PROBLEM	POSSIBLE CAUSE
Timer knob will not rotate	Not plugged in.
Dryer does not operate.	The circuit breaker tripped or blown fuse.
Drum does not rotate	Door is not closed.
Laundry not completely dry	Clean the Filter Reduce the amount of clothing loaded in the dryer. Re-dry the loaded items Ensure items are not knotted or bulked together. Dryer is not located in a well ventilated area.