



HC20X SERIES

QUICK SETUP GUIDE

Home
& Business

SECURITY SYSTEMS

What's in the Box

Package Contents

DISCLAIMER: The exact components of your system, images and quantities may vary depending on your model number. While these may vary, this Quick Setup Guide will address the setup and initial configuration of your Hybrid DVR and cameras.



Hybrid DVR (x1)

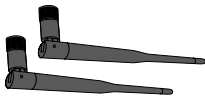

Hybrid DVR Antenna (x2)

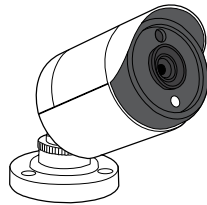

Wired Camera(s)

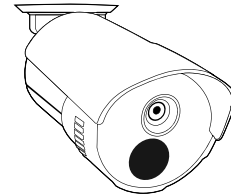

Wireless Camera(s)

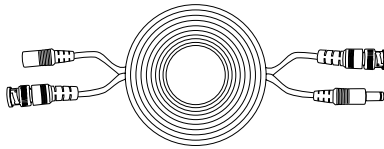

60 ft. Video/Power Cables
(1 cable per wired camera)

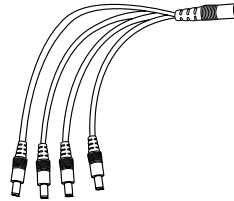

Power Splitter(s)
(1 per 4 wired cameras)



6 ft. HDMI (x1)

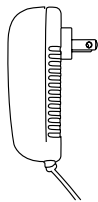

Hybrid DVR Power Adapter (x1)

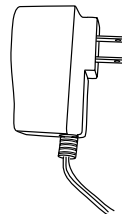

Camera Power Adapter(s)
(1 per 4 wired cameras)
(1 per wireless camera)

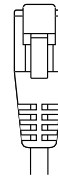

6 ft. Ethernet (x1)

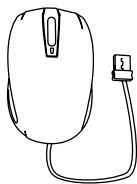

USB Mouse (x1)



Wireless Camera
Antenna (1 per camera)

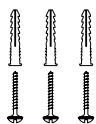

Mounting Hardware
(3 per camera)



Safety Sticker (x3)

Items Not Included

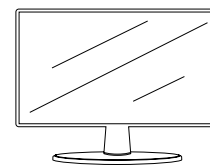

Monitor

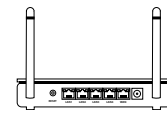

Router

NOTE: Monitor is required
for initial setup.

IMPORTANT: For best results, use all the included Night Owl accessories. Third-party accessories may not work properly.

Product Overview

Hybrid DVR Rear View

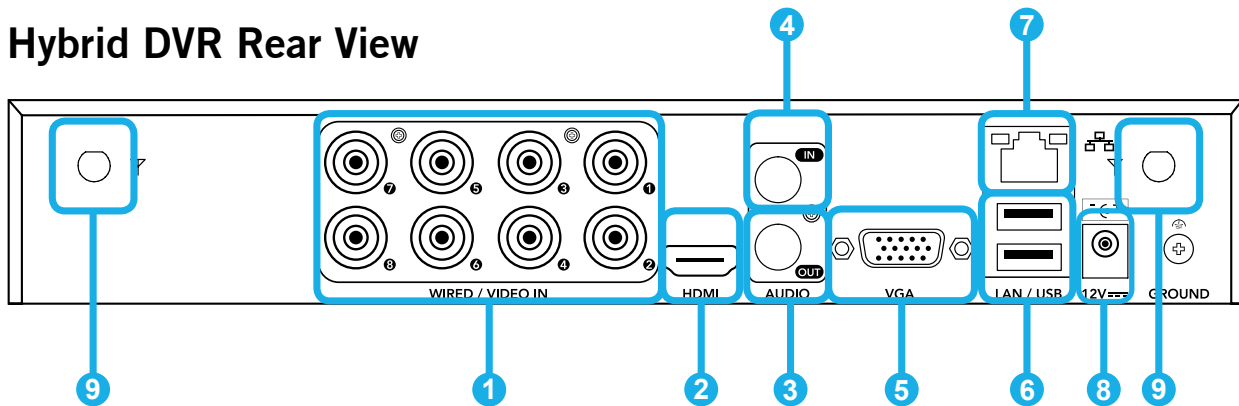

Images used are for reference only. Your product may vary slightly depending on your model number.

- 1 Video Inputs** – Allows for the connection of BNC wired cameras. Wireless cameras connect to the DVR's built-in Wi-Fi.
- 2 HDMI Output** – Allows for the video connection. If the TV/Monitor has an HDMI input, connect the HDMI cable from the HDMI output port on the DVR to the HDMI input port on your TV/Monitor. **NOTE: Preferred method.**
- 3 Audio Output** – Allows for the connection of an amplified speaker using an RCA connector.
- 4 Audio Input** – Allows for the connection of audio enabled cameras by connecting the white RCA plug to one of the audio inputs. After making the audio input connection, be sure to enable the audio function in the DVR's menu interface.
- 5 VGA Output** – Allows for the video connection. If the TV/Monitor has a VGA input, connect the VGA cable from the VGA output port on the DVR to the VGA input port on your TV/Monitor (*VGA Cable not included. VGA Port not available on all models*).
- 6 USB Ports** – Allows for the connections of a USB mouse and/or a USB flash drive. You will connect the included USB mouse to assist you in navigating the DVR's menu interface. You will connect a USB flash drive to download video files from the DVR and save them to your USB flash drive.
- 7 RJ-45 (Ethernet) Port** – Used to connect the DVR to your router/modem via the included Ethernet cable.
- 8 Power Input** – Used to connect the included 12V DC power supply.
- 9 Hybrid DVR Antenna Mount** – For installation of two included antennas.

Connecting Your System



- 1 Plug included HDMI cable into the HDMI port on the back of the DVR.



NOTE: Monitor is required for initial setup. To view cameras, TV/Monitor must be tuned to the same Input the HDMI is plugged into.

- 2 Plug the other end of the HDMI cable into the back of the TV or Monitor.



- 3 Plug the USB mouse into the USB port on the back of the DVR.



ETHERNET

- 4 Plug the included Ethernet cable into the LAN port on the back of the DVR.



ETHERNET



(Router Not Included)

- 5 Plug the other end of the Ethernet cable into a numbered port on the back of the router.



DISCLAIMER: Camera/cable quantities may vary.

STOP: To verify cameras are working, please ensure they appear on your TV/Monitor before mounting them.

Connecting Your Wired Cameras

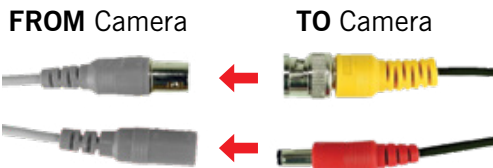

NOTE: Audio enabled cameras will have a white RCA connector to transmit audio signal (Optional).

- 6 Connect the ends of the cable attached to the camera to the ends of a video/power cable labeled **TO CAMERA ONLY**.

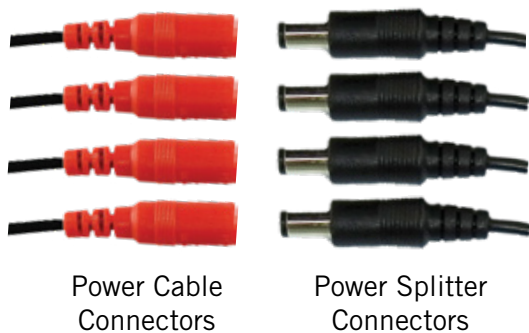

- 8 Connect the red female power leads of the video/power cables to the male power splitter ends.



- 10 Connect the DVR power adapter to the Power Input on the rear of the DVR.



NOTE: Make sure you twist and lock BNC connectors.

- 7 Connect the BNC connector of the video/power cable labeled **TO DVR ONLY** to an open video input on the DVR.

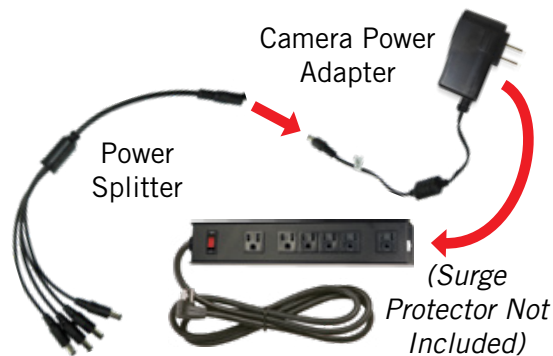

NOTE: Power adapters are labeled **TO CAMERA ONLY** and **TO DVR ONLY**.

- 9 Connect the power splitter to the camera power adapter and plug the adapter into a surge protector or Uninterruptible Power Supply (UPS).

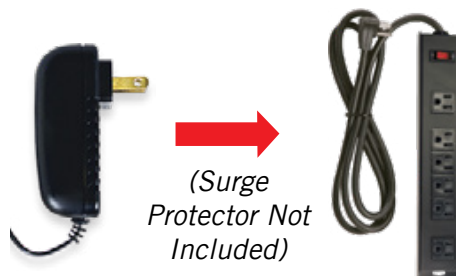

NOTE: Some systems will beep upon booting up.

- 11 Plug the DVR power adapter into a surge protector or Uninterruptible Power Supply (UPS).

NOTE: Check that the UPS or surge protector is switched ON.

Connecting Your Wireless Cameras

DISCLAIMER: Not all Hybrid kits come with wireless cameras. If you have purchased wireless cameras as add-ons, please use the pairing guide included with the cameras for connectivity.

- 1 Connect the included camera antenna to the antenna mount on your wireless camera.

NOTE: Each wireless camera comes with 1 antenna and mount.

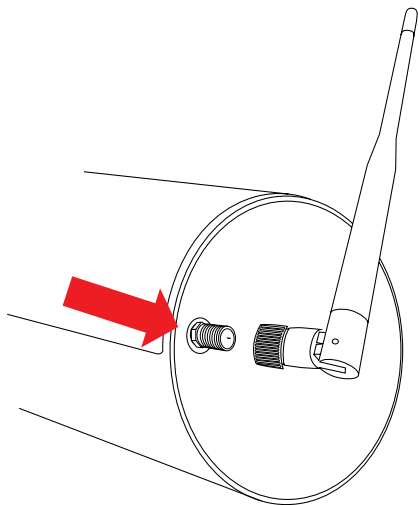

- 2 To verify your wireless camera is working, please ensure it appears on your TV/Monitor before mounting.

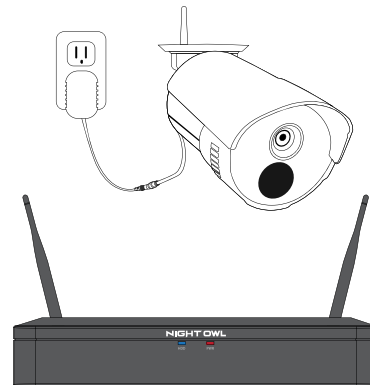

STOP Make sure DVR is in intended location before testing cameras.

- 3 Each wireless camera comes equipped with its own camera power adapter. Connect the female power cable coming from the camera to the male power end of the camera power adapter. Next, plug the camera power adapter into a wall outlet.

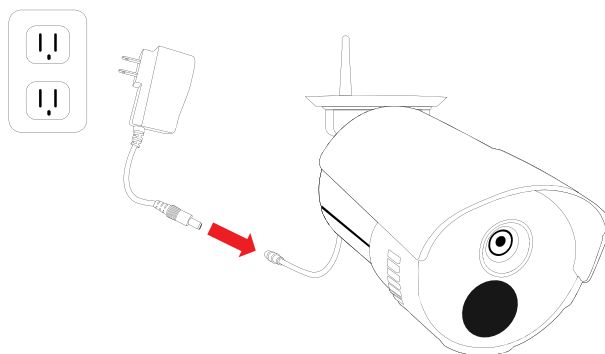

NOTE: With the wireless camera powered on, you should see it appear on your TV/Monitor within 3 minutes. Once it appears, you may proceed to mount the wireless camera in its intended location. If the wireless camera does not appear, please refer to page 6 of this Quick Setup Guide to re-pair the wireless camera to your DVR.

Pairing a Replacement Wireless Camera

By default, each wireless camera within your DVR kit comes pre-paired to the DVR. Additionally, your DVR has its own built-in Wi-Fi for secure, uninterrupted video transmission and recording. Pairing allows for the wireless transmission coming from the wireless camera to be detected by the DVR. However, if you have a wireless camera that needs to be replaced while under warranty, the replacement camera will similarly need to be paired to the DVR.

To pair a replacement wireless camera to your DVR, please use the below steps:

- 1 Power on the replacement camera using the camera power adapter.

NOTE: This should be done locally at the DVR to avoid interference.

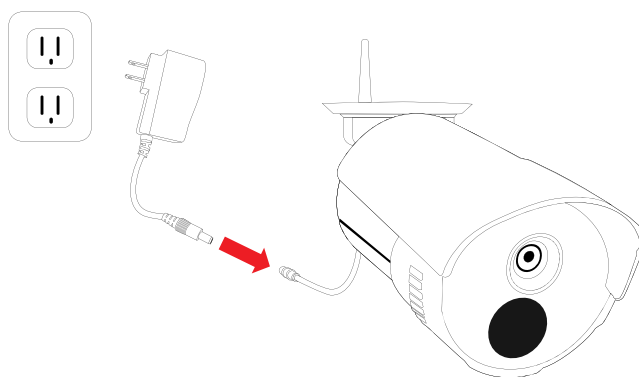

- 2 With the DVR connected to a TV/Monitor, access the Live Feed screen for your connected cameras.

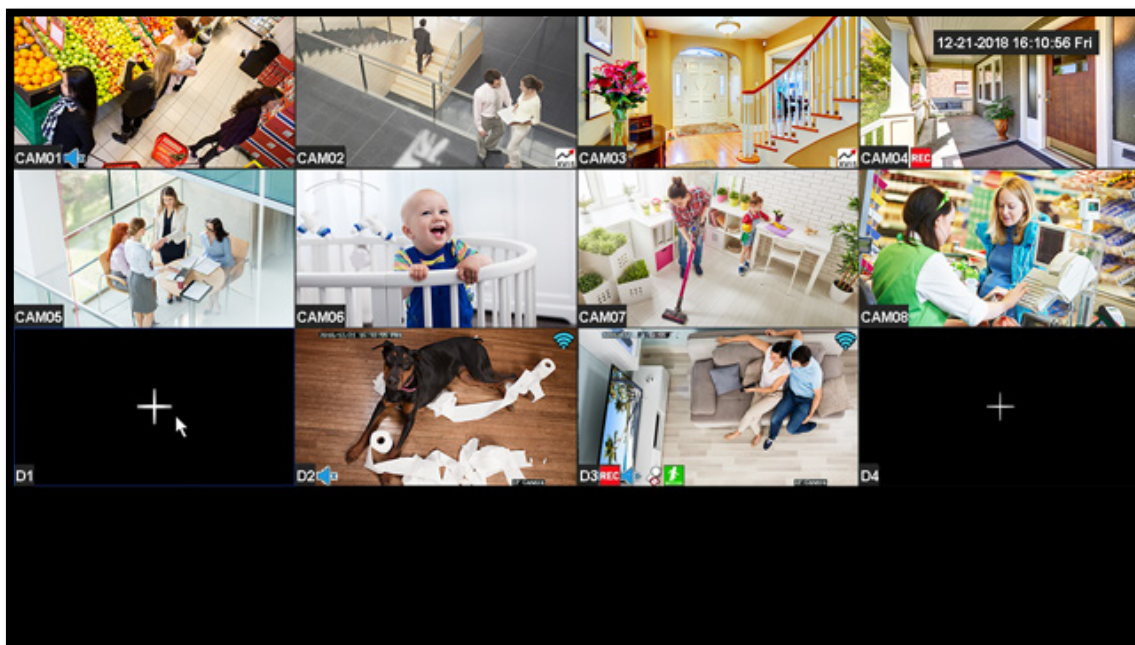

Pairing a Replacement Wireless Camera

- 3 Next, you will need to reset the replacement camera. To do so, press and hold the reset button until you hear a beep, indicating the camera has begun the reset process.

NOTE: The reset button location may vary by model. The reset process may take up to 3 minutes.

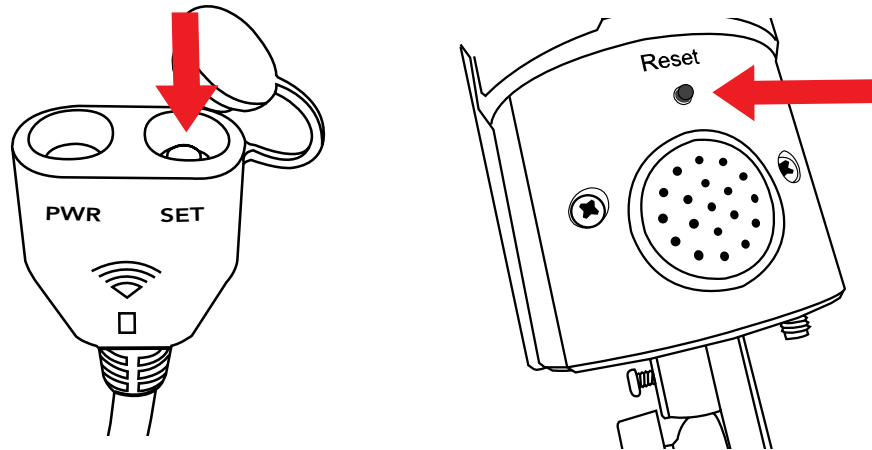

- 4 After 3 minutes have passed or after hearing the camera beep, click on the + icon on an available wireless channel within the Live View feed.

NOTE: Wireless channels will be named with a D, to signify Wireless Device.

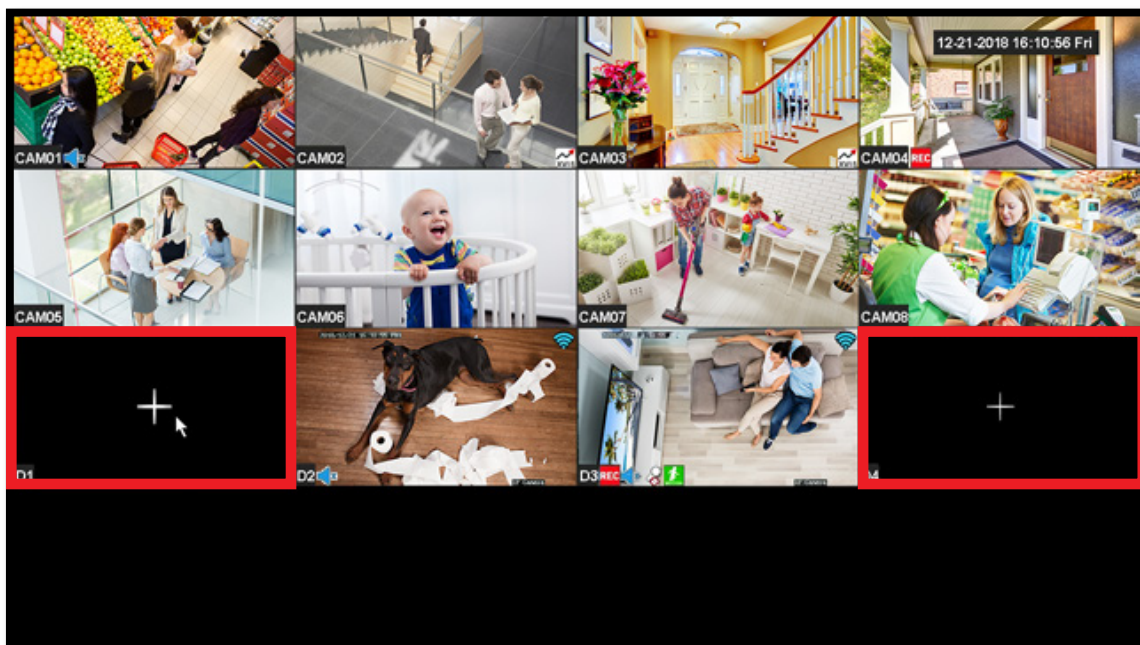

- 5 Select Next from the menu to search for available wireless cameras to pair.

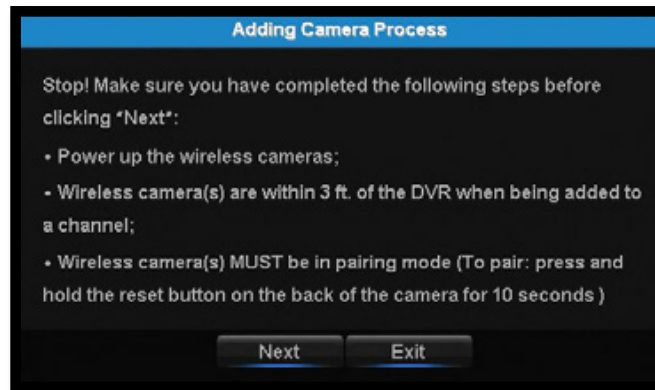

- 6 The DVR will now locate your new wireless camera and begin the pairing process.

NOTE: It may take up to 3 minutes for the camera to pair.

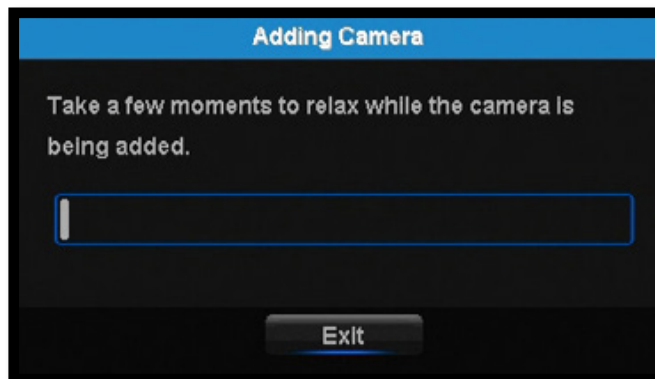

- 7 If you have not exceeded the channel limitation, the new camera will appear in a vacant video field once paired.

WooHoo! Your replacement camera has now been paired to the DVR using the DVR's built in Wi-Fi.



Positioning Your DVR and Cameras

Each wired camera within this Hybrid kit is hardwired to the DVR. However, each wireless camera is paired using the DVR's built-in Wi-Fi. Due to wireless signal limitations, placing your DVR centrally for wireless connectivity is key.

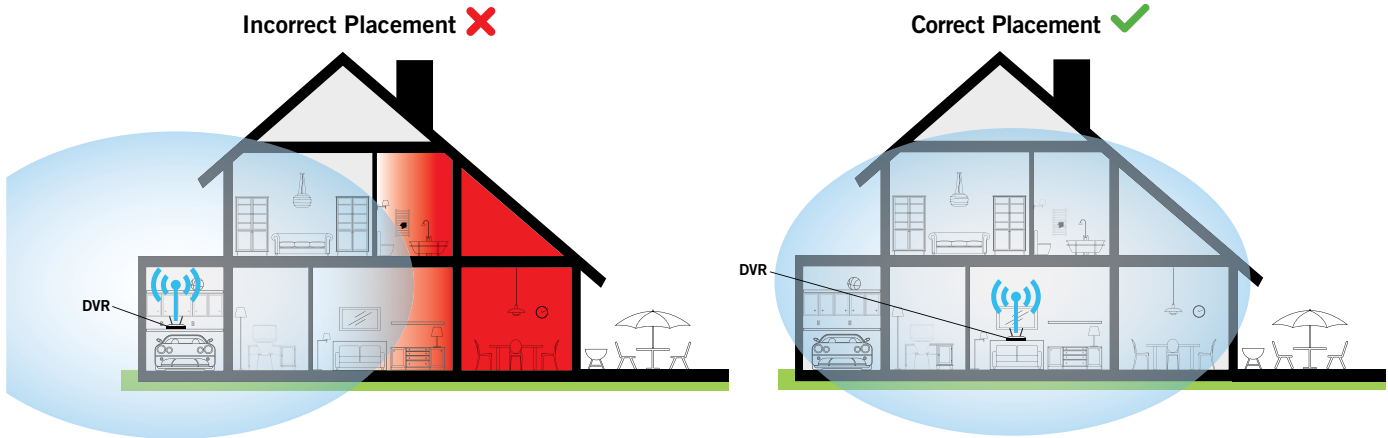

How Obstacles Affect Your Signal Strength

Obstructions affect the signal strength differently. Some obstacles, such as concrete walls may heavily impact the signal strength and wireless range of the camera.

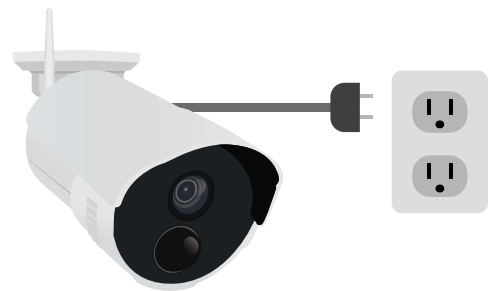
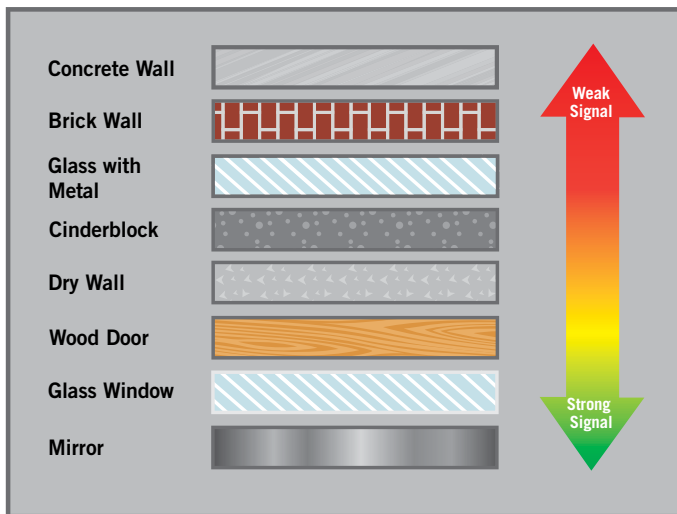

Powering Your Wireless Cameras

Each wireless camera must be powered using the included camera power adapter. These are not battery-powered cameras and must be connected to a wall outlet. A standard extension cable can be used if needed.

Booting Up for the First Time

Startup Wizard

- 1 When you power on the DVR you will be prompted with the following screen. Please follow the instructions to complete the Startup Wizard.

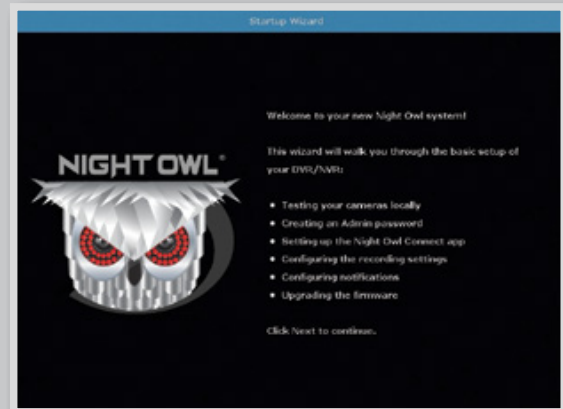

Important... Please Read

- 2 On the **Password Creation** screen, please note the following:



Admin Account Creation

By default, the username will be **admin**. It must remain **admin** upon your initial account configuration. However, you may add additional users at a later time.

NOTE: Password can be any alphanumeric combination between 6 and 20 characters.



Recovery Email Address

Please ensure you provide a valid email address in case you ever forget your account information.

NOTE: You **MUST** enter a **VALID** email address. If you don't, you will have to call Tech Support to reset your password, and that just seems like a waste of time.



Remember Your Password

Night Owl strongly recommends writing down your password within the Quick Setup Guide. You will need it every time you log into your DVR and to remotely view on a Smart Device.

Write your
password here:

Booting Up for the First Time

- 3 When you reach the **Camera / Channel Settings** screen, you will want to have installed the cameras in their final position. Please make sure you have mounted cameras at least 7ft. above the ground and angled them slightly down.



NOTE: If your camera has an infrared sensor, it works best for 'side to side' movement across the camera's field of view as opposed to directly to or away from the camera.

At this stage of the Startup Wizard, you will be instructed on adjusting the camera sensitivity and setting the Motion Detection Area. Having your cameras in their final position will be key.

To detect motion for the front door to your home, place the camera to the side of the entrance.

- 4 This is the last screen you will see when you have successfully completed the Startup Wizard.

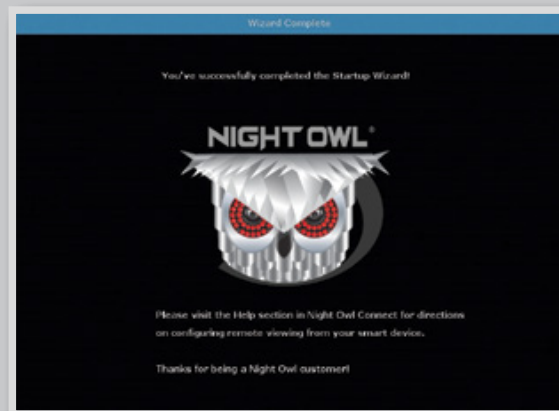

NOTE: Need more help configuring your DVR? Please refer to the owner's manual located on the support page at www.NightOwlSP.com.

Creating Additional Users within the DVR

The **admin** of the DVR has more privileges than standard users. When configuring your system for remote viewing, we strongly recommend not giving more than one (1) Smart Device **admin** access. Up to three (3) users can remotely view the DVR simultaneously. If there are multiple users who will be viewing the DVR on their Smart Device, we encourage the **admin** to create additional users at the DVR level.

To add additional users to the DVR:

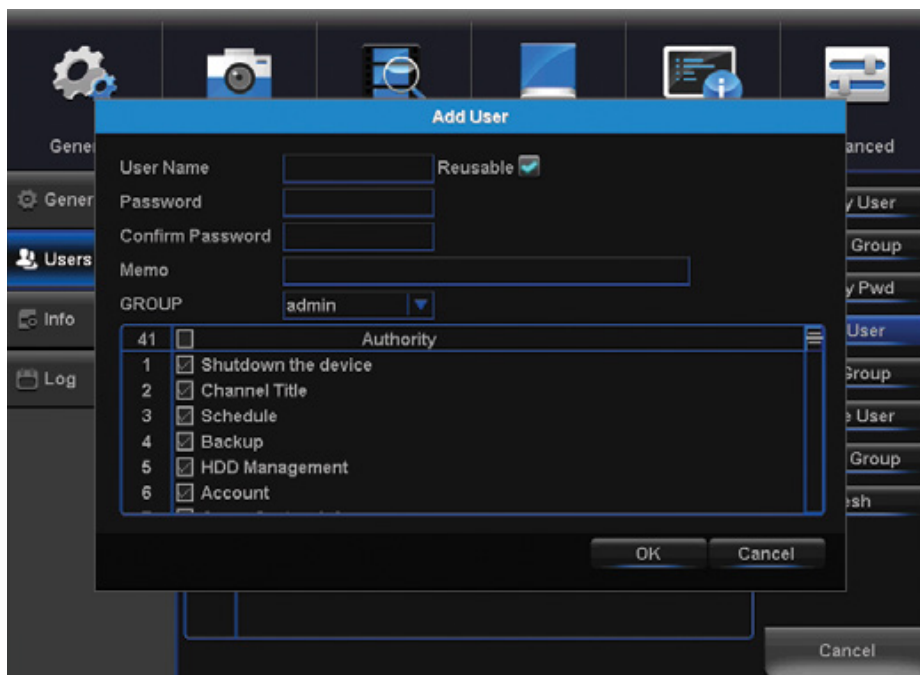

- 1 Right click to pull up the Menu.
- 2 Select Menu.
- 3 Login.
- 4 Select System.
- 5 Select User.
- 6 Select Add User.
- 7 Create a Username and Password for the new user.
- 8 Select the appropriate authority group for the user (user/admin).
- 9 Check or uncheck authority options to set user or admin permissions.
- 10 Select OK to apply new settings.

NOTE: If the **admin** login is used on multiple Smart Devices simultaneously, additional users will be able to override **admin** changes.

Using Night Owl Connect

Download and Install Application

- 1 Download the app from the *App Store* or *Google Play Store* and install the application on your device.

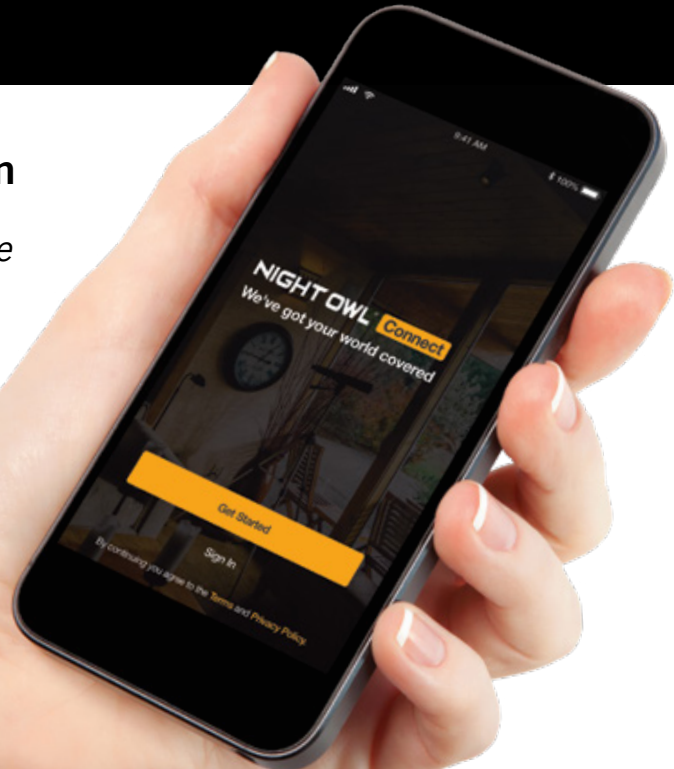

NOTE: Setup is the same for Smartphone and Tablet.

- 2 Create an account using an email address for the username and a password between 6–20 characters.
- 3 After completing the account setup and verification process, sign into the app and tap the “+” symbol to add a device.

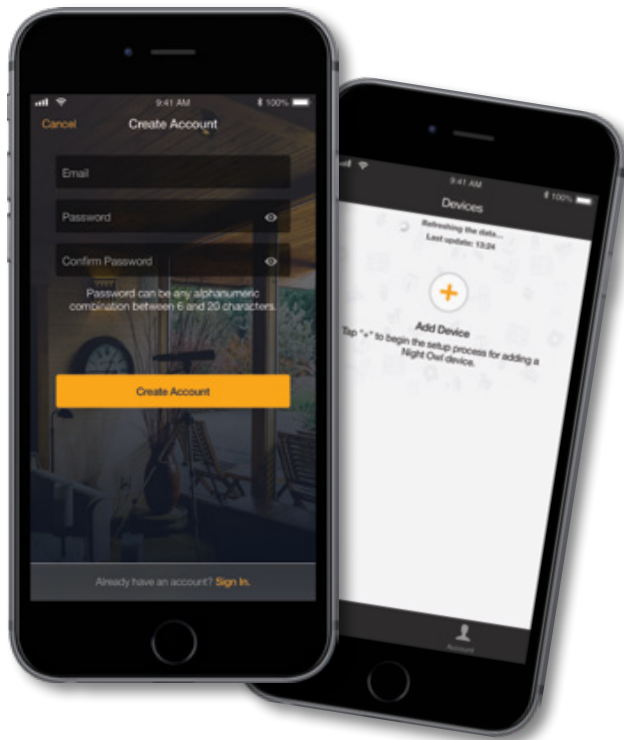

The Night Owl Application will lead you through the rest of the setup process.

Using Night Owl Connect

Connecting and Adding your Device

NOTE: When adding a new device, it may take 5–10 minutes before you begin receiving notifications.

A device can be added to the Night Owl Connect App by using the application's **Smart Auto Detection** or through a **QR Code Setup**. With Smart Auto Detection, your DVR will automatically be detected by the Night Owl Connect software, making connecting easy! To use this preferred method, ensure your Smart Device and DVR are both on the same network.



4 Adding a Device

To begin adding a new device, first select the yellow plus sign within the Device menu. Then select your device type from the Device list and follow the on screen instructions.

4A Smart Auto Detection

If your DVR and Smart Device are running Night Owl Connect on the same network, the Smart Auto Detection will find your DVR. If this method is not available, please use the QR Code Setup from step 4B below.

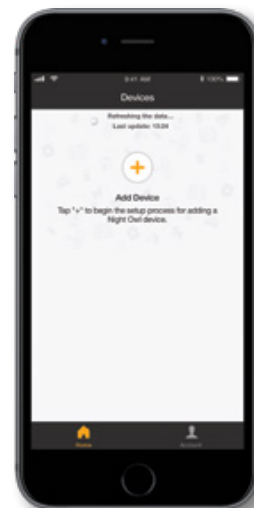

4B QR Code Setup

To use the QR Code Setup, select Setup device by QR Code within the Night Owl Connect App, and hover your Smart Device camera lens over the QR Code located on the top of your DVR.



- 5 On the Device Login screen, enter the login information for the DVR (Remember, the DVR login and Night Owl Connect App login are different). The DVR username is **admin** by default. If you are not the **admin**, login with your username credentials.

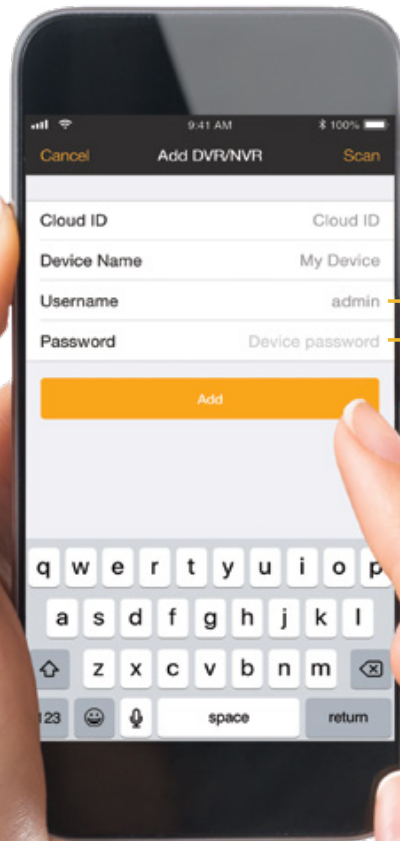

admin is case sensitive
(all lowercase).

The password will be the same password you created during the Startup Wizard and should be stored in your Quick Setup Guide. **NOTE: This is the password of your DVR, NOT the password used to login to the Night Owl Connect App.** You must key the DVR password verbatim to add it to the app.

Using Night Owl Connect

App Overview

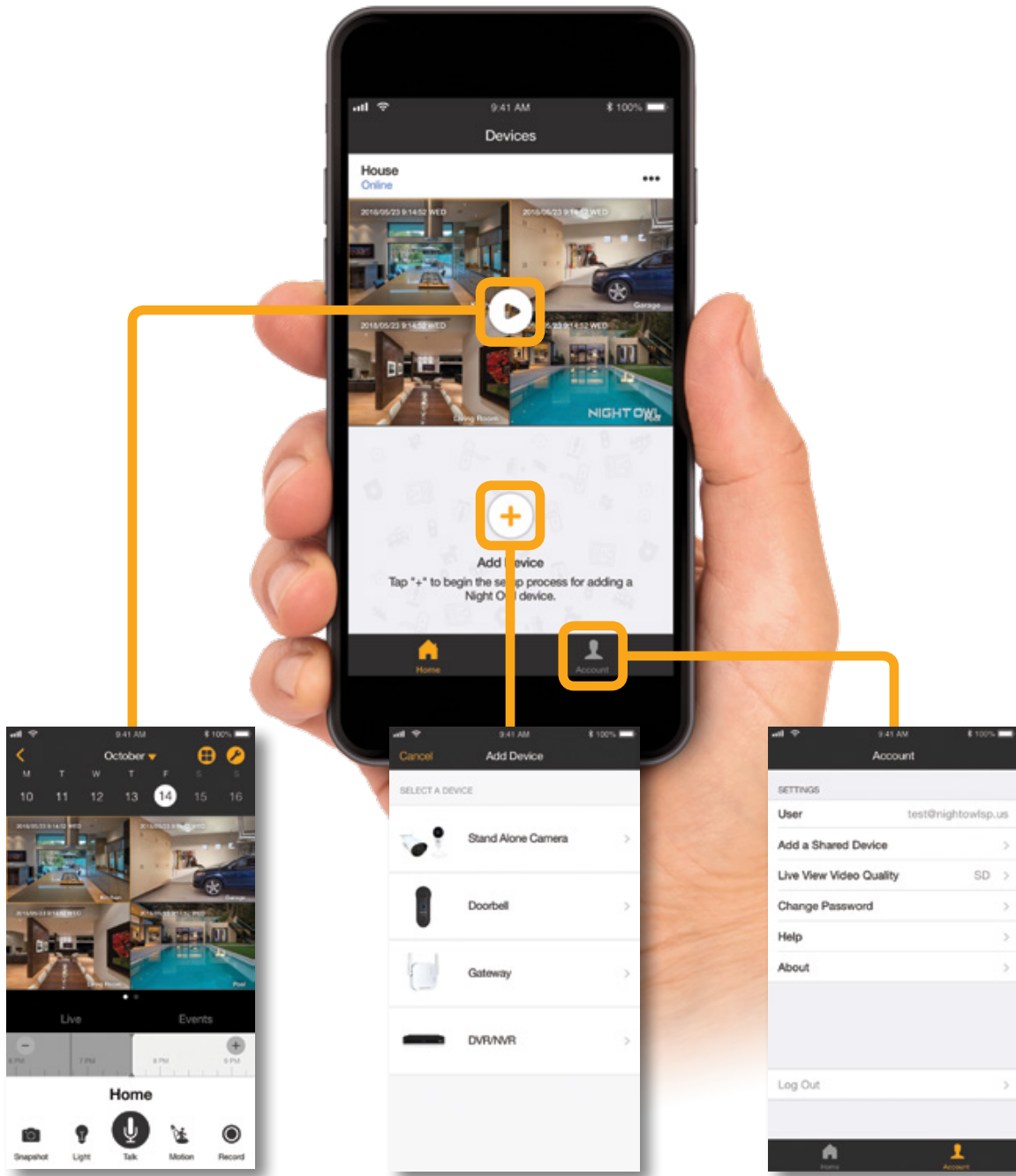

Live View
Displays real-time
footage of your
system.



Add Device
Add connected devices
to your DVR.



Account
Manage account settings,
add a shared device, and
change password.

Using Night Owl Connect CMS Software

Access your DVR from any computer, anywhere!



Live View

Viewing live video, customizing layouts and setting image parameters.



Playback

View system recordings and images and save them directly to your PC or Mac®.



Device Manager

Add and configure available DVRs and cameras on your network.

Night Owl Connect CMS Software

The Night Owl Connect Control Management Software (CMS) allows you to view your Night Owl Security system remotely from a PC or Mac®. Additionally, you can playback recorded video, save video and images directly to your PC or Mac®, configure numerous settings such as channel names and set record preferences.

To download the CMS Software:

- 1 Go to www.NightOwlSP.com.
- 2 Click on the Support tab.
- 3 In the search bar, type “**Connect CMS**”.
- 4 Download the **Night Owl Connect CMS** software.
- 5 Once downloaded, select **PC** or **Mac®**.

FAQs

1. Does my DVR have to be connected to the Internet?

Your DVR does not require an Internet connection for basic operation, but you will need to connect the DVR to your router to remotely view your system on a PC/Mac® or Smart Device.

2. Does my DVR have to be connected to a TV or monitor?

For initial setup, you will need to connect your DVR to a TV or monitor. After completing the initial setup, your DVR does not need to be connected to a TV or monitor to view or capture recordings. You can view your system using the Night Owl Connect CMS Software on a PC/Mac® or by downloading the Night Owl Connect App on your Smart Device.

3. Are my cameras weatherproof?

Yes, your cameras are weatherproof and will endure minimal moisture and dirt/debris. However, Night Owl strongly recommends placing all outdoor cameras under an eave or awning to help shield them from overexposure to the elements, which could reduce your camera's lifespan.

4. Why does my camera stop working at night?

Your camera might not be receiving enough power for the LEDs needed for Night Vision. Plug the camera directly into the camera power adapter (bypassing the splitter) to see if the LEDs turn on. If they do, you may need to purchase an additional camera power adapter for that camera.

5. Why is the Night Owl Connect App not accepting my password?

Night Owl Apps require two passwords. One is for logging into the app, and the other is the DVR's admin password. To add a device to the app, enter the DVR's admin password. Remember, you **MUST** confirm your email by clicking the "Confirm Email" link in the verification email sent by Night Owl during setup.

6. Why can't I connect using the Night Owl Connect App or Night Owl Connect CMS Software?

If you are having trouble connecting using the mobile app or client software: A) your system may not be connected to a router; B) the latest firmware or client software may not be installed; C) the DVR password was entered incorrectly; D) you may need to restart your DVR; E) the network upload speed may be too slow, contact your ISP.



CONTACT US

PHONE

Technical Support (English, Spanish & French)

1.866.390.1303

Live Chat 24/7, 365 days a year

Pre-Sales Support

1.866.979.0580

EMAIL

Sales Support

Sales@NightOwlSP.com

Technical Support

Support@NightOwlSP.com

WEBSITE

24/7 Product Support

- How-To Videos
- Manuals

Need Help?

For system manuals, troubleshooting guides, FAQs, video tutorials and more:

Please refer to the sticker located on top of the device for steps on how to access your product's support material.



www.NightOwlSP.com



YouTube

iPhone, iPad, Mac and Mac OS X are registered trademarks of Apple Inc. Windows, Windows XP, Windows Vista, Windows 7, Windows 8 and Windows 10 are registered trademarks of Microsoft Corporation in the United States and/or other countries.

FCC RADIATION NORM

FCC

This device complies with Part 15 of the FCC Rules. Operation is subject to the following two conditions: (1) this device may not cause harmful interference, and (2) this device must accept any interference received, including interference that may cause undesired operation.

FCC Compliance Statement

These limits are designed to provide reasonable protection against frequency interference in residential installation. This equipment generates, uses, and can radiate radio frequency energy, and if not installed or used in accordance with the instructions, may cause harmful interference to radio communication. However, there is no guarantee that interference will not occur in television reception, which can be determined by turning the equipment off and on. The user is encouraged to try and correct the interference by one or more of the following measures:

- Reorient or relocate the receiving antenna.
- Increase the separation between the equipment and the receiver.
- Connect the equipment into an outlet on a circuit different from that to which the receiver is connected.
- Consult the dealer or an experienced radio/TV technician for help.

CAUTION!

The Federal Communications Commission warns the user that changes or modifications to the unit not expressly approved by the party responsible for compliance could void the user's authority to operate the equipment.

This equipment should be installed and operated with a minimum distance of 8 inches between the radiator and your body.