

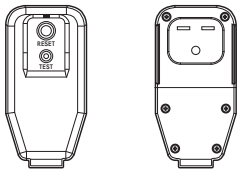

INSTALLATION

Electrical Data

Power cord may include a current interrupter device. **TEST** and **RESET** buttons are provided on the plug case. The device should be tested on a periodic basis by first pressing the **TEST** button and then the **RESET** button. If the **TEST** button does not trip or if the **RESET** button will not stay engaged, discontinue use of the air conditioner and contact a qualified service technician.

for 240 V



Use Wall Receptacle	Power Supply
 <p data-bbox="142 872 399 941">Standard 240 V, 3-wire grounding receptacle rated 15 A / 240 VAC / 60 Hz</p>	<p data-bbox="416 830 588 898">Use 15 A, time delay fuse or 15 A, circuit breaker.</p>

! WARNING

- This appliance should be installed in accordance with the National Electrical Code.
- Use of extension cords could cause serious injury or death.
 - Do not use an extension cord with this window air conditioner.
 - Do not use surge protectors or multi-outlet adapters with this window air conditioner.
- Never push the **TEST** button during operation. Doing so can damage the plug.
 - Do not remove, modify, or immerse this plug. If this device trips, the cause should be corrected before further use.

! CAUTION

- The conductors inside this cord are surrounded by shields, which monitor leakage current. These shields are not grounded. Periodically examine the cord for any damage. Do not use this product in the event the shields become exposed. Avoid shock hazard. This unit cannot be user-serviced. Do not open the tamper-resistant sealed portion. All warranties and performance will be voided. This unit is not intended to be used as an ON/OFF switch.

Installation Overview

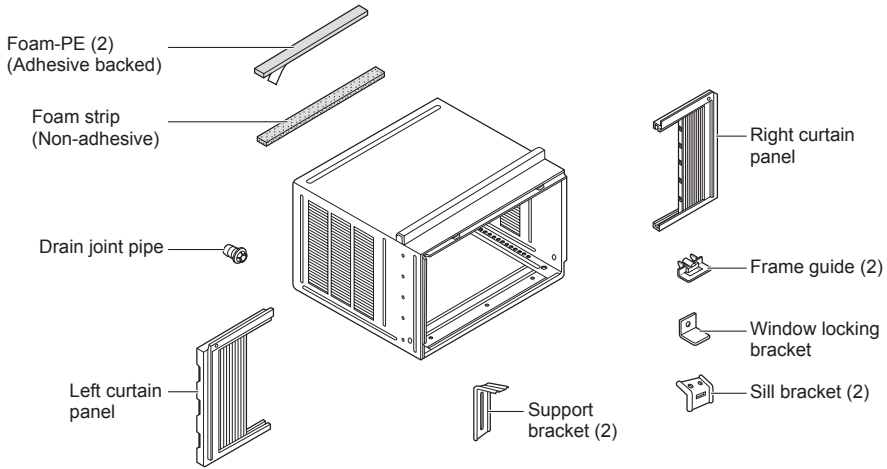

Accessories

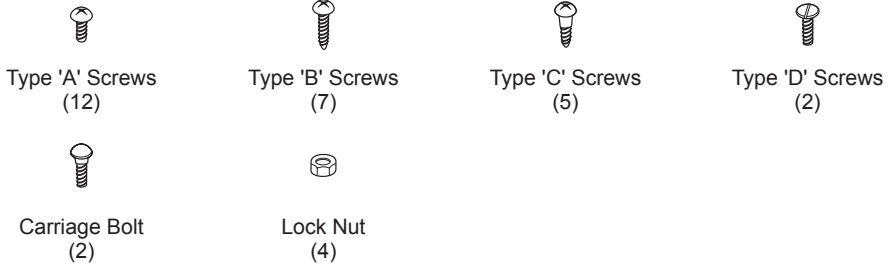

Tools Needed

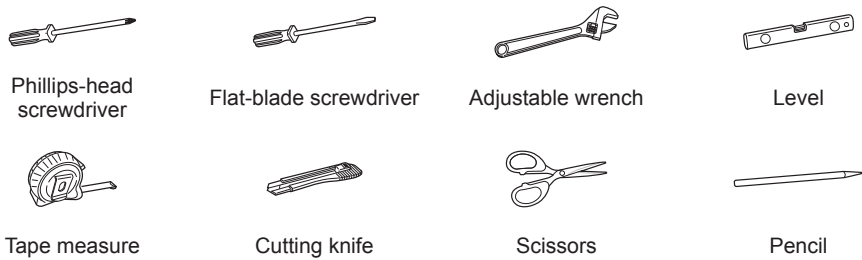

How to Install the Unit

- 1 To prevent vibration and noise, make sure the unit is installed securely and firmly.
- 2 Install the unit where the sunlight dose not shine directly on the unit.
- 3 The outside of the cabinet must extend outward for at least 12" and there should be no obstacles, such as a fence or wall, within 20" from the back of the cabinet because it will prevent heat radiation of the condenser. Restriction of outside air will greatly reduce the cooling efficiency of the air conditioner.

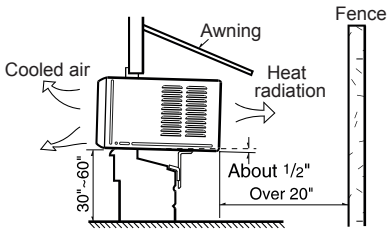

CAUTION

- All side louvers of the cabinet must remain exposed to the outside of the structure.

- 4 Install the unit slightly tilted so the back is slightly lower than the front (about 1/2"). This will force condensed water to flow to the outside.
- 5 Install the unit with the bottom between 30" ~60" above the floor level.

Window Requirements

- This unit is designed for installation in standard double hung windows with actual opening widths from 29" to 41". The top and bottom window sashes must open sufficiently to allow a clear vertical opening of 19" from the bottom of the upper sash to the inside sill.
- The height offset between the inside sill and outside sill must be less than 1 1/4".

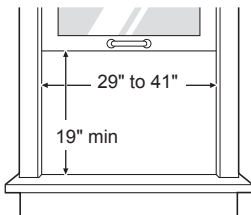

NOTE

- All supporting parts should be secured to firm wood, masonry, or metal.

Preparation of Cabinet

- 1 Remove 4 screws which fasten the cabinet at both sides and at the back. (Keep the screws for later use.)

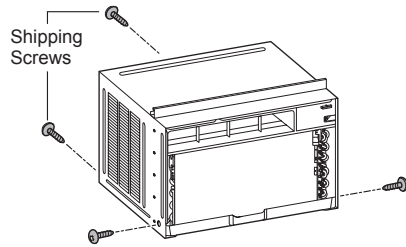

- 2 Slide the unit from the cabinet by gripping the base pan handle and pulling forward while bracing the cabinet.

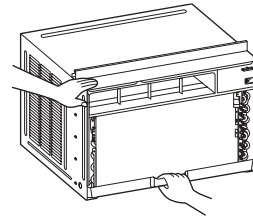

CAUTION

- The unit is heavy. To prevent injury, use proper lifting techniques when pulling unit forward from cabinet. Obtain assistance from another person if possible.

- 3 Cut the window sash seals (Foam-PE) to the proper length. Peel off the backing and attach the adhesive-backed foam to the underside of the window sash and the bottom of the window frame.

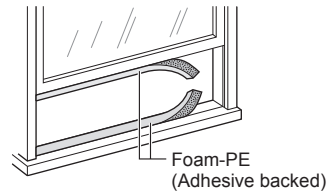

- 4 Insert the lower curtain panel guides into the bottom of the cabinet. Insert the guides so that the flange faces to the rear of the cabinet.

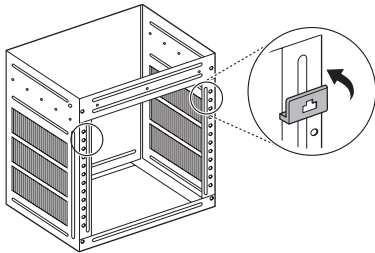

- 5 Insert the top and bottom rails of the curtain panels into the upper and lower panel guides.

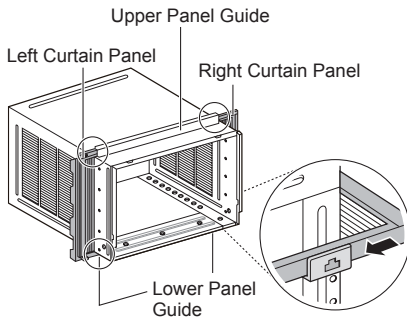

CAUTION

- The lower panel guides are easily broken. Be careful with them when installing the cabinet.

- 6 Fasten the curtain panels to the unit with 10 type A screws.

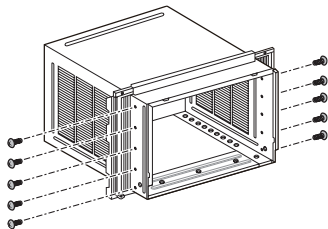

Cabinet Installation

- 1 Open the window. Mark a line on the center of the inside sill and extending across the center of the outside sill. Loosely attach each sill bracket to a support bracket using a carriage bolt and a lock nut.

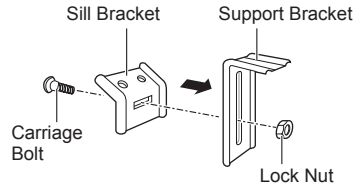

- 2 Carefully place the cabinet in the window and align the center hole on the cabinet bottom front with the center line marked on the window sills. Align the support brackets with the cabinet track holes and mark the sill along the sides of each sill bracket. Remove the cabinet from the window and attach each sill bracket on the outside sill between the marks using 2 type B screws.

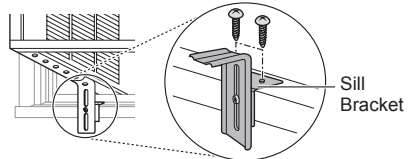

- 3 Carefully place the cabinet back in the window and align the cabinet track holes with the support brackets. Attach each support bracket to the cabinet through a cabinet track hole, using a type D screw and a lock nut. Use the first track hole past the sill bracket on the outer edge of the window sill. Tighten the lock nuts on the support brackets to secure them to the sill brackets. Be sure the cabinet slants down toward the outside.

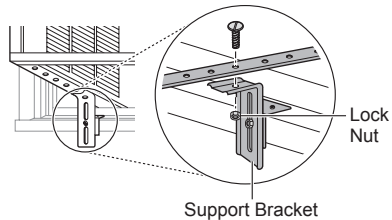

- 4 Pull each curtain panel out until it meets the window sash track. Pull the bottom window sash down behind the upper panel guide until they meet.

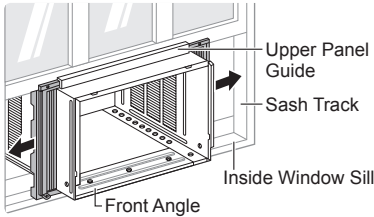

NOTE

- Do not pull the window sash down so tightly that the movement of the curtain panels is restricted.

- 5 Attach the cabinet to the inside sill by driving 3 type B screws through the cabinet and into the sill.

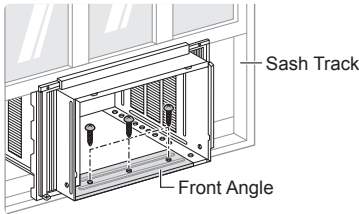

NOTE

- Install the cabinet with a very slight downward tilt toward the outside.

CAUTION

- Do not drill a hole in the bottom pan. The product is designed to operate with approximately 1/2" of water in the bottom pan.

- 6 Use a screwdriver or power drill to attach the curtain panels to the window sashes by driving type C screws into the sashes through the cabinet holes shown in the figure below.

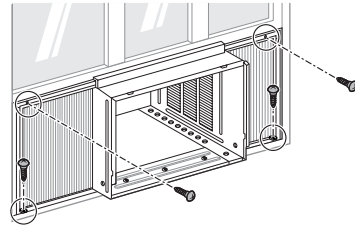

- 7 With the aid of an assistant, slide the unit into the cabinet. Reinstall the screws removed from the cabinet sides in step 1.

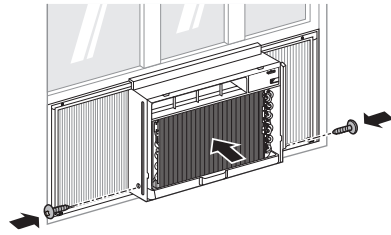

CAUTION

- The unit is heavy. Use an assistant to help lift the unit and set it in place. Lifting and maneuvering the unit by yourself could result in injury.
- Hold the unit firmly in place until the window frame is lowered to meet the top surface of the unit directly behind the upper guide. If the unit falls from the window, it could cause personal injury or property damage.

14 INSTALLATION

- 8 Cut the non-adhesive foam strip to the proper length and insert it between the upper window sash and the lower window sash.

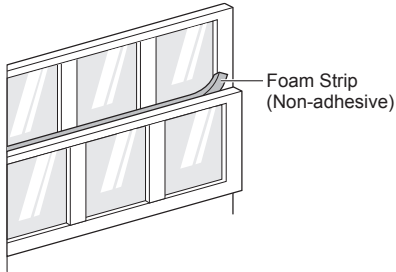

- 9 Attach the window locking bracket with a type C screw.

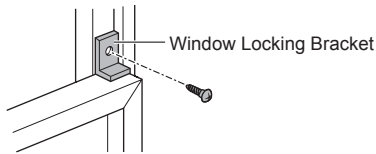

- 10 Fold out the vent control lever located to the left of the control panel, as shown.

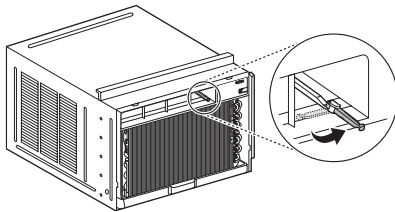

- 11 Connect the wire harness from the front grille assembly to the air conditioner.

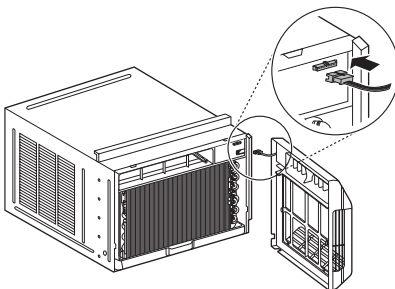

- 12 Attach the front grille assembly to the cabinet by inserting the grille tabs into the slots on the front of the cabinet. Push the grille in until it snaps into place.

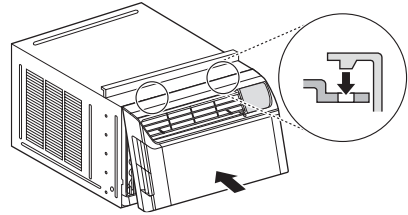

- 13 Open the air inlet grille and secure the front grille assembly with 2 type A screws through the both sides of the front grille. (There are 2 type A screws packed in a small bag.)

