

Montageanleitung	de
Assembly Instructions	en
Instruction de montage	fr
Istruzioni per il montaggio	it
Instrucciones de montaje	es
Instruções de montagem	pt
Montagehandleiding	nl
Samlevejledning	da
Monteringsanvisning	sv
Monteringsveiledning	no
Asennusohje	fi
Összeszerelési útmutató	hu
Instrukcja montażu	pl
Инструкция по сборке	ru
Návod na montáž	sk
Uputstvo za montažu	hr
Navodila za montažo	sl

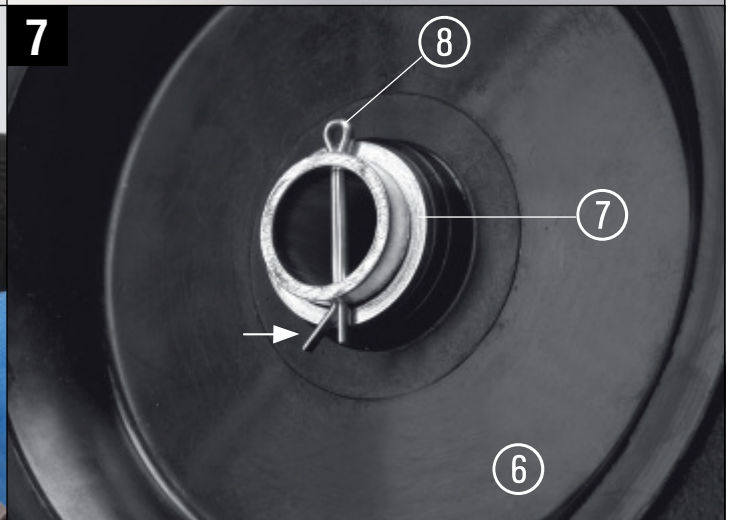

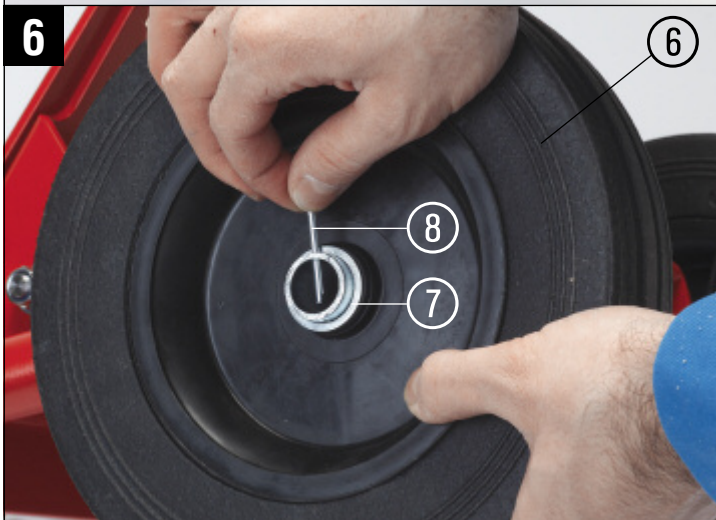

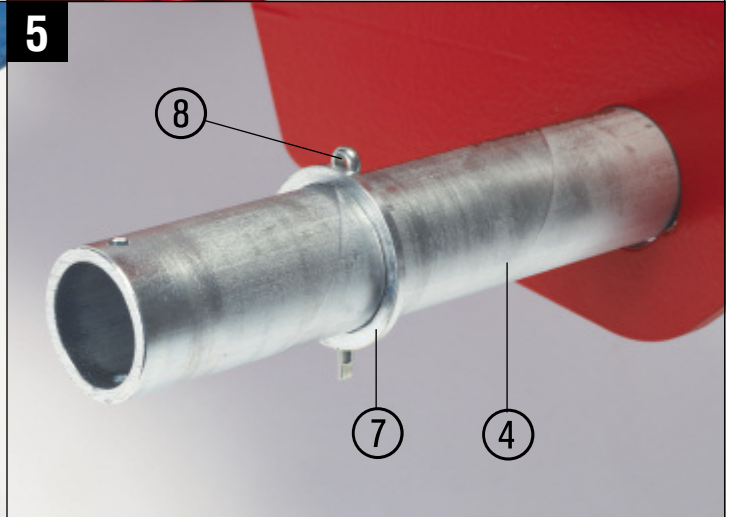

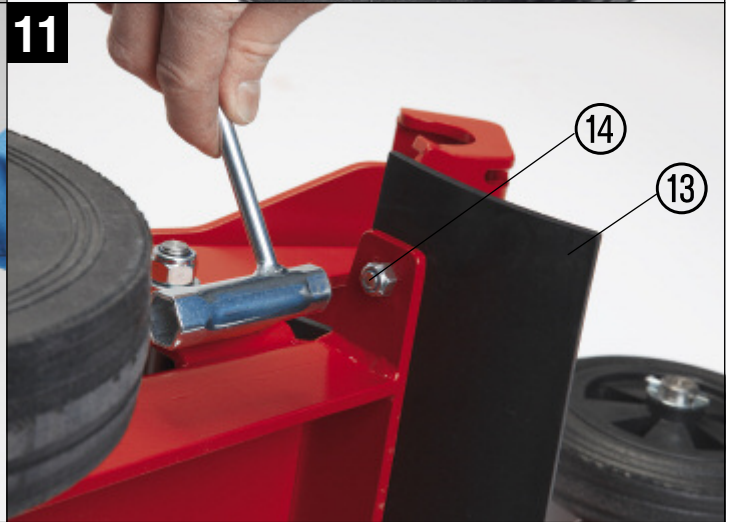
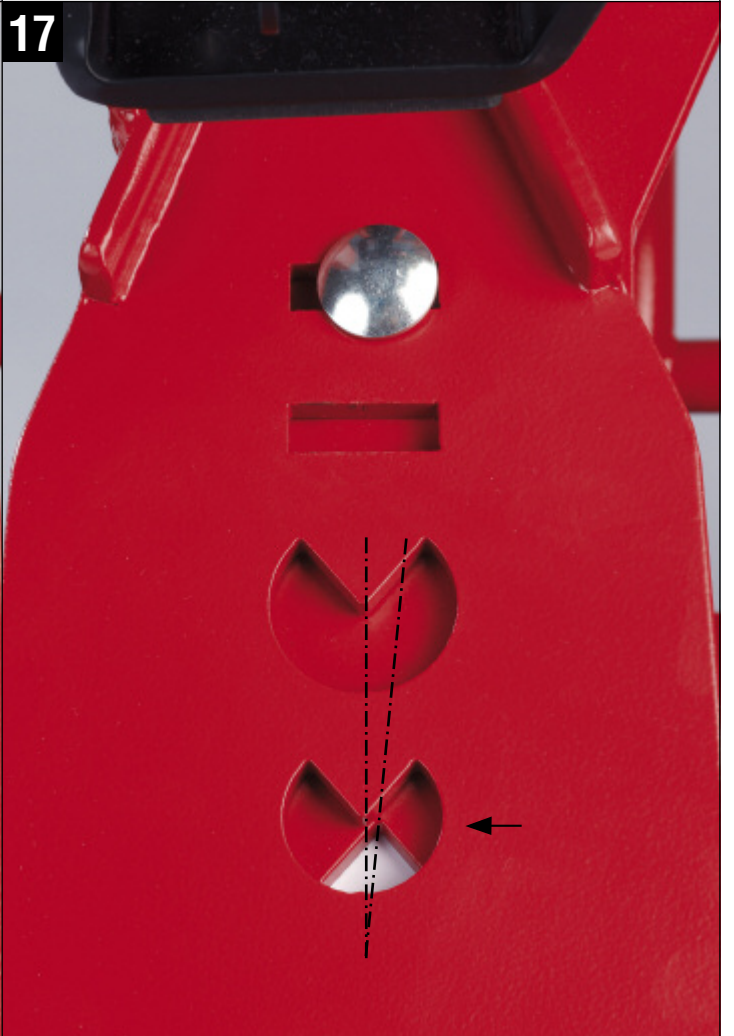
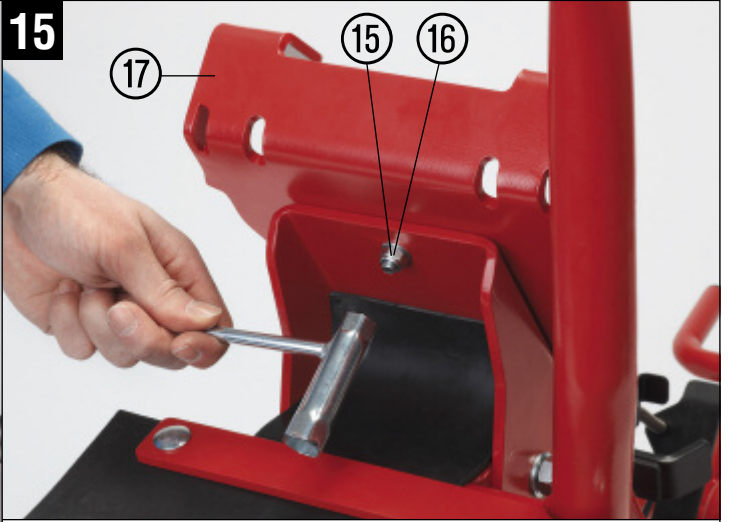
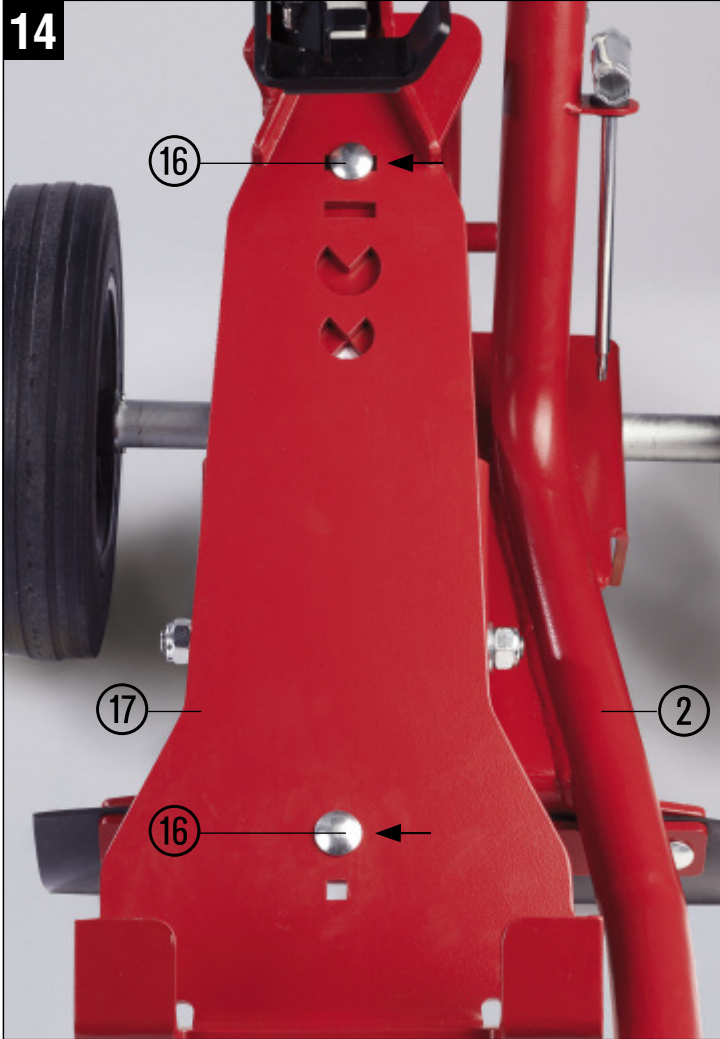

18



19



20



21



22



23



24



25



26



DSH-FSC floor saw cart assembly instructions

1. Safety precautions

- Use this floor saw cart only in conjunction with the Hilti DSH 700 or DSH 900 gas saws.
- Observe the instructions and safety precautions listed in the operating instructions for your Hilti gas saw.

2. Assembling the floor saw cart

2.1 Fitting the handle 2 3

Fit the handle ① to the frame ② and secure it with the screw knob ③.

2.2 Fitting the wheel axle to the frame 4

Push the wheel axle ④ into the holes in the frame ② and secure it with the screw knob ⑤.

2.3 Fitting the second wheel 5 6 7

Secure the second wheel ⑥ on the wheel axle ④ by fitting the washer ⑦ and split pin ⑧.

2.4 Fitting the front wheel 8 9

Fit the front wheel ⑨ to the front wheel axle ⑫ and secure it with the washer ⑩ and split pin ⑪.

2.5 Fitting the spray guard 10 11

Use the two the screws ⑭ to secure the spray guard ⑬ to the frame ②.

3. Adjusting the machine mount

- **Note:** The machine mount is set in such a way that the saw arm of the DSH 900-40 gas saw does not come into contact with the floor when cutting to full depth. When used with the DSH 900-35, DSH 700-35 and DSH 700-30, the machine mount must be fitted in a lower position in order to reach full cutting depth.

3.1 Disassembling the machine mount 12 13

Remove both hex. nuts ⑮ and screws ⑯ from the machine mount ⑰.

3.2 Fitting the machine mount in the lower position 14 15 16

Insert the two screws ⑭ in the upper openings in the machine mount ⑰ and secure the machine mount to the frame ② once again.

- **Note:** When fitting the machine mount, take care to ensure it is aligned centrally.

4. Adjusting for straight running

- **Note:** The floor saw cart is designed so that the gas saw cuts in a straight line when the mark on the machine mount is in the middle position. If it is found that the gas saw pulls to one side while cutting, this can be compensated by adjusting the position of the machine mount.

4.1 Adjusting the machine mount 17 for straight running

Release the upper hex. nut ⑮ on the machine mount ⑰ and pivot the rear of the machine mount toward the side to which the saw tends to pull when cutting.

5. Fitting the gas saw 18 to 26

1. Bring the height adjustment lever ⑱ into the upper position.
2. Release the screw knob ⑳ on the grip clamp ⑲.
3. Place the gas saw in the forward section of the machine mount with its wheels positioned as shown in the illustration and then pivot the grip of the saw ㉔ into the grip clamp ⑲.
4. Secure the gas saw by tightening the screw knob ㉑.
5. Fit the water container ㉒ after filling it.
6. Adjust the position of the handle to bring it into a comfortable working position.
7. Adjust the disc/blade guard.



Hilti Corporation

LI-9494 Schaan

Tel.: +423 / 234 21 11

Fax: +423 / 234 29 65

www.hilti.com



431274