



WS2036

INSTALLATION GUIDE



LEGION FURNITURE

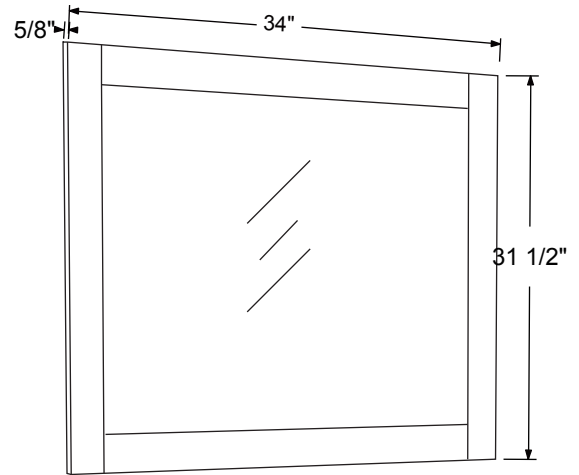
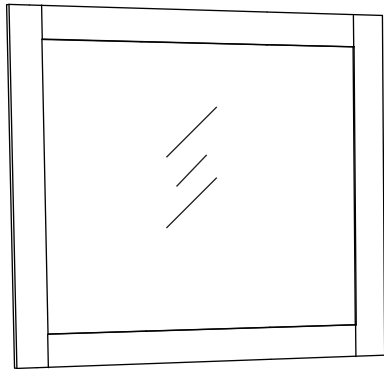

Mirror



Vanity Ensemble

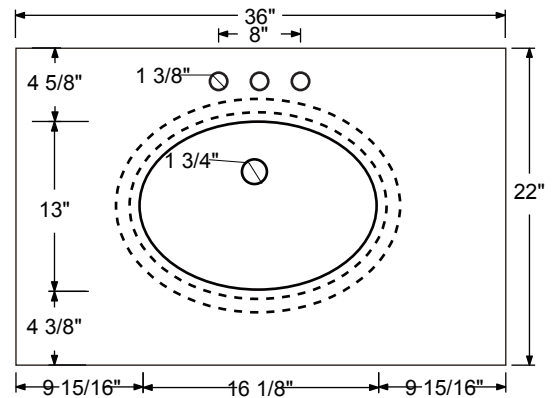

Sink

Note: All dimensions and specifications are approximate and subject to change without notice.



LEGION FURNITURE

WS2036

INSTALLATION GUIDE

PAGE 1



WS2036

INSTALLATION GUIDE



LEGION FURNITURE

Vanity Front

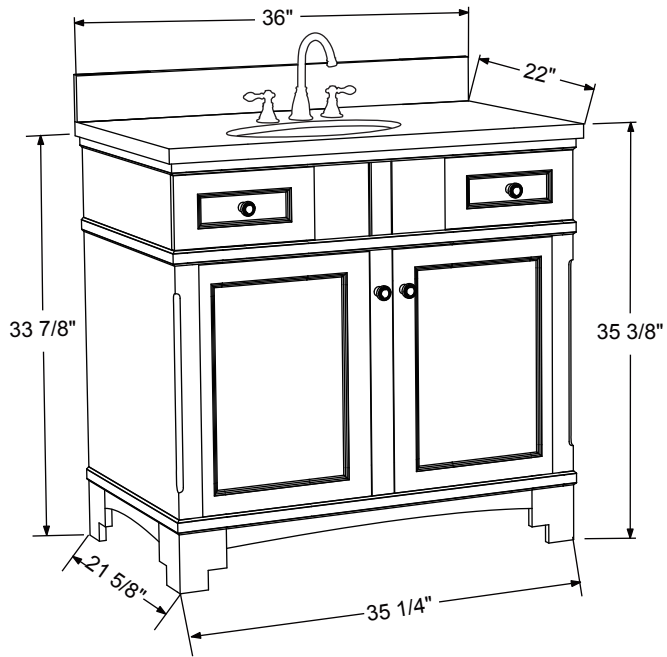

Vanity Back

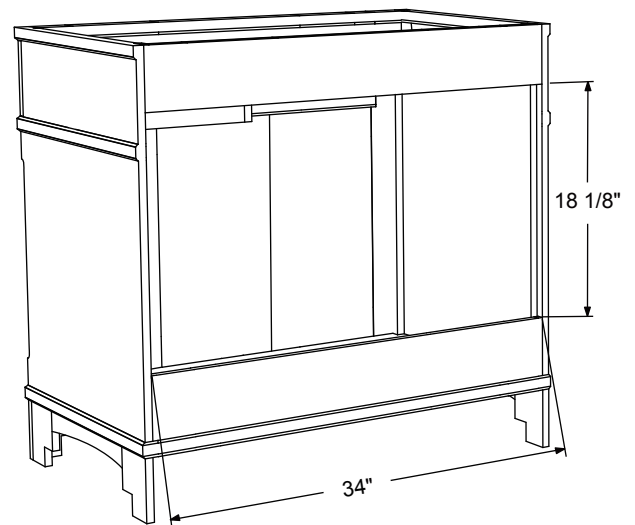

MIRROR INSTALLATION INSTRUCTION

TOOLS FOR ASSEMBLY



- 1 Measure the distance between the brackets on the back of the mirror

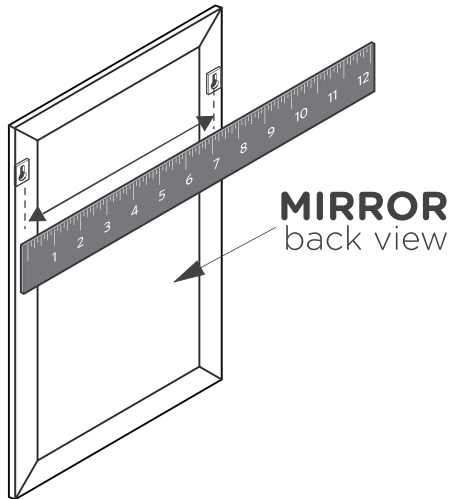

- 2 Mark the measured distance on the wall using a level

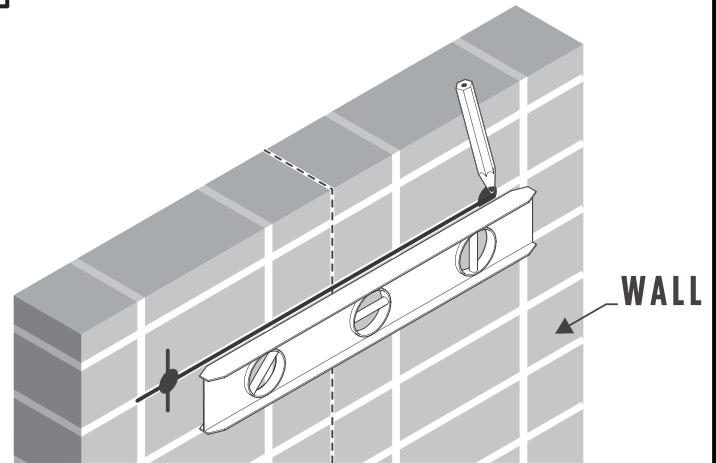

- 3 Once position is marked, drill 2 holes and insert anchors if stud is not available

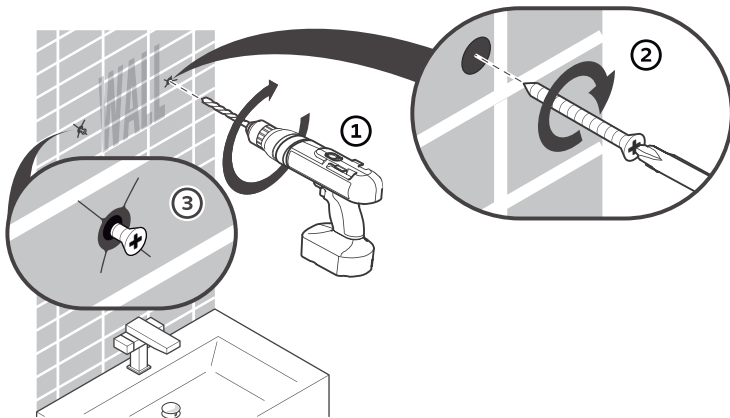

- 4 Hang mirror on the wall

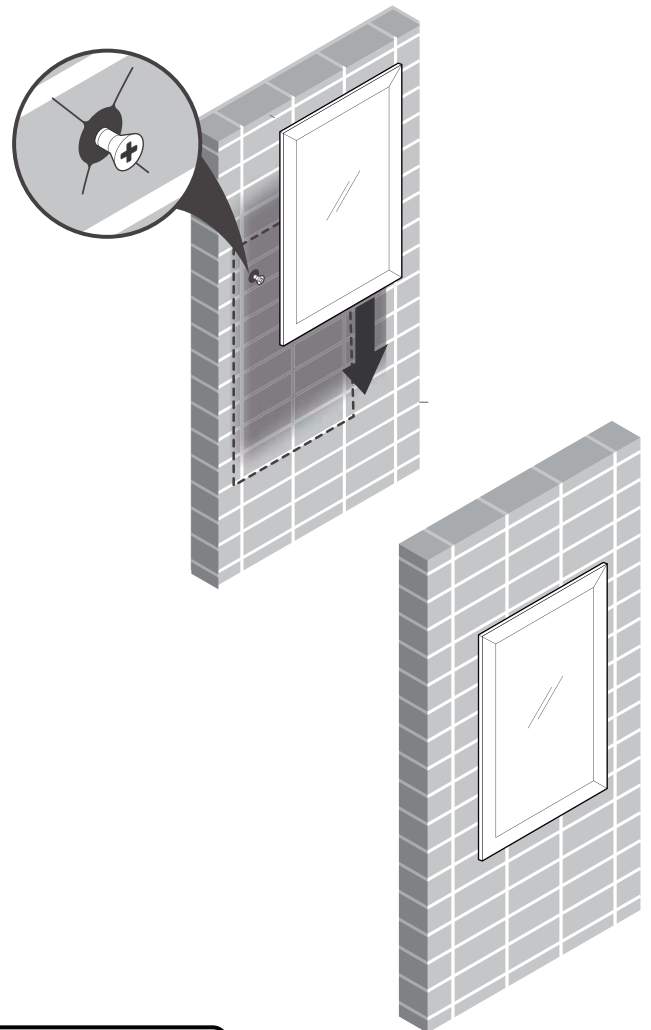

IMPORTANT:

CONSULT AN EXPERT FOR THE PROPER SCREWS/BOLTS TO USE WHEN ATTACHING TO VARIOUS WALL CONSTRUCTIONS. SCREWS PROVIDED **DO NOT** ATTACH TO ALL WALL CONSTRUCTION TYPES.



LEGION FURNITURE

WS2036

INSTALLATION GUIDE

PAGE 3

DRAWER REMOVAL

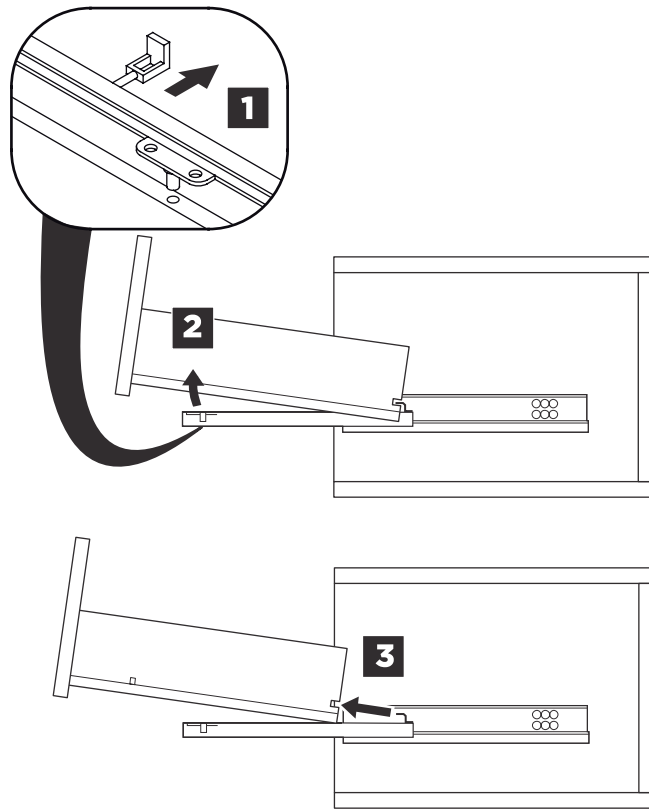

DRAWER INSTALLATION

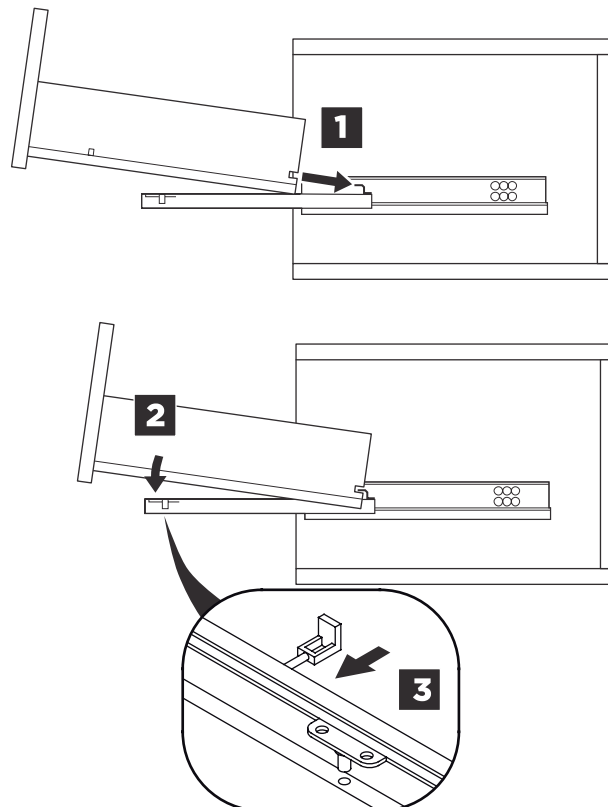

INSTALLATION INSTRUCTIONS

1 Secure cabinet to the wall

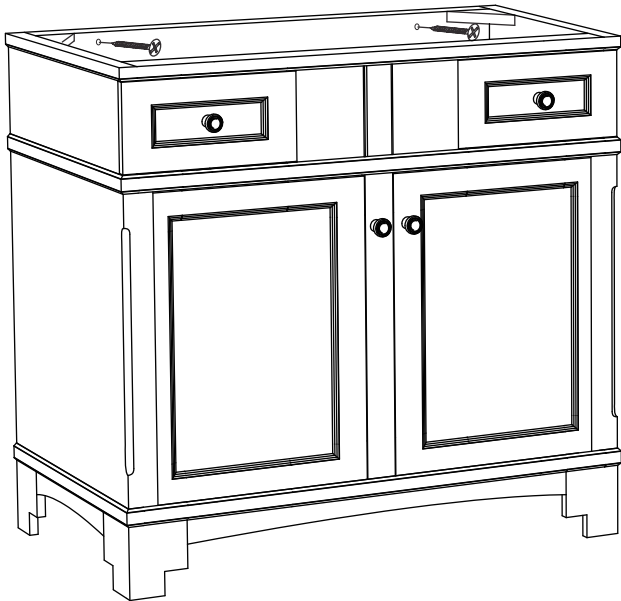

2 Apply a bead of silicone on the top of the cabinet and place the sink on top

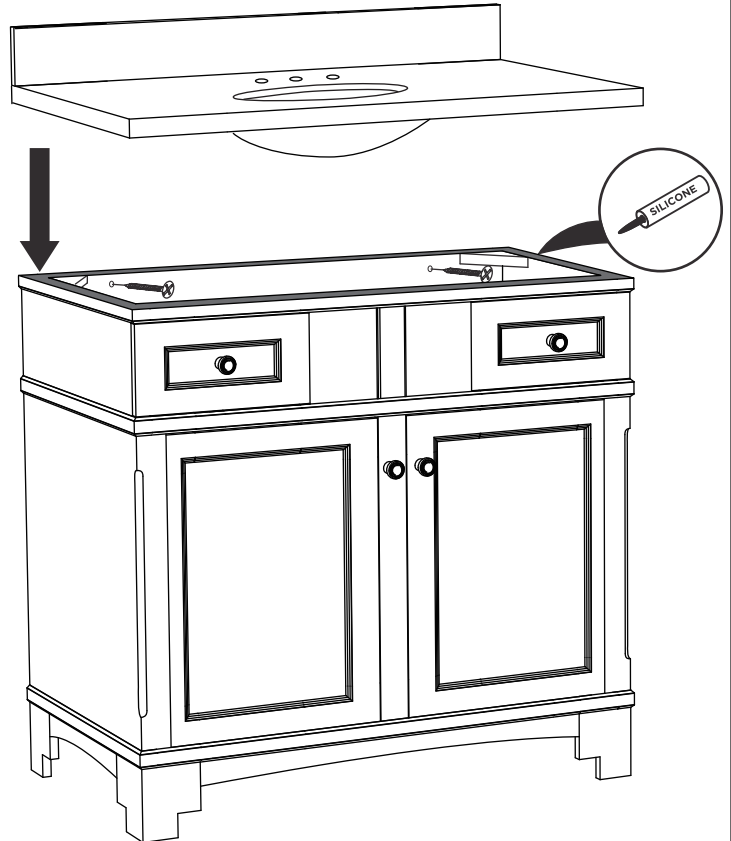

IMPORTANT:
Consult an expert for the proper screws/bolts to use when attaching to various wall constructions. Screws provided do not attach to all wall construction types.



LEGION FURNITURE

WS2036

INSTALLATION GUIDE

PAGE 5

P-TRAP & POP-UP

INSTALLATION INSTRUCTIONS

Your item may appear slightly different from the illustration.

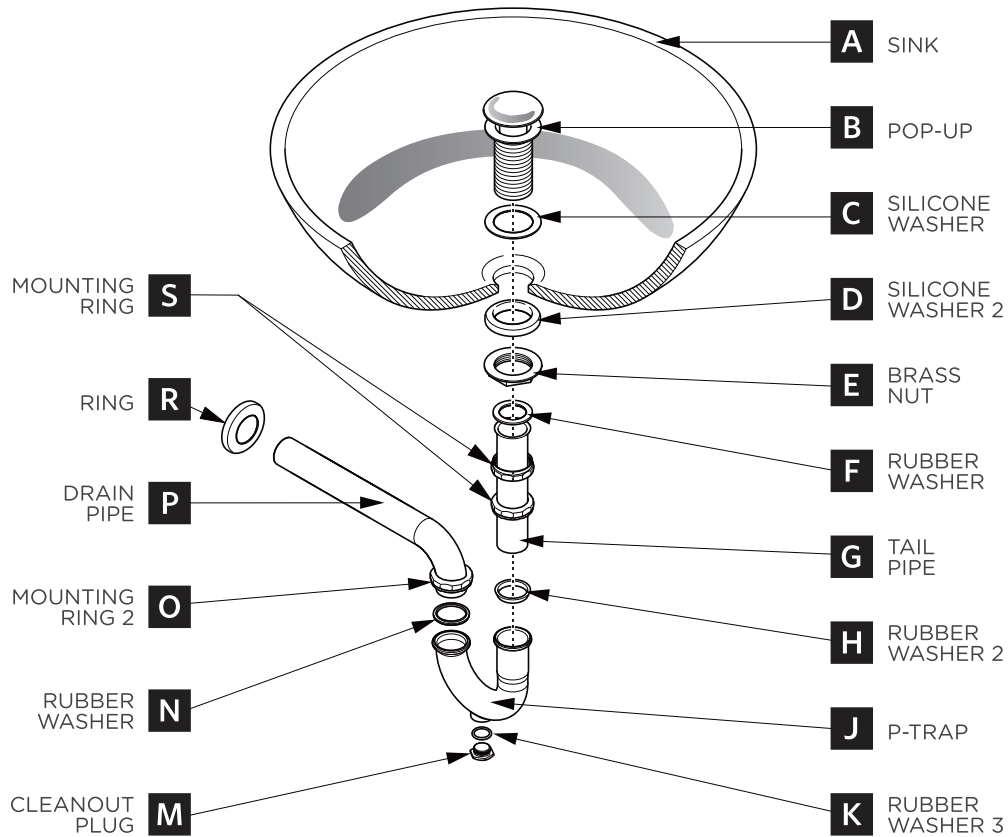

POP-UP INSTALLATION

FOR SINKS WITHOUT OVERFLOW

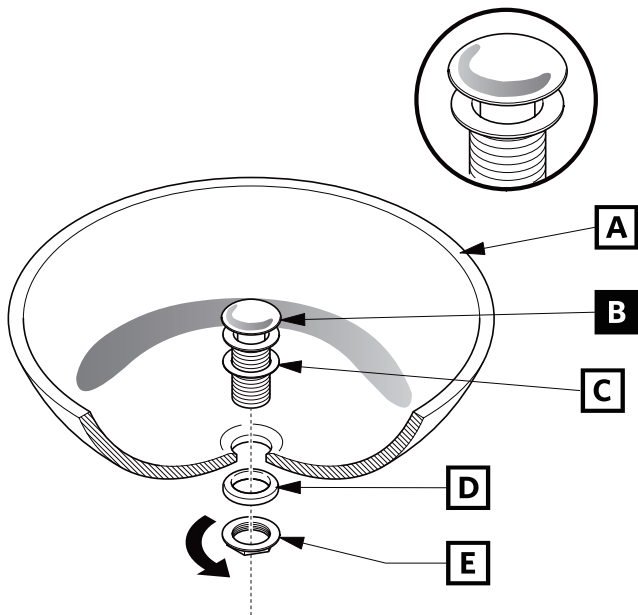

OR

FOR SINKS WITH OVERFLOW

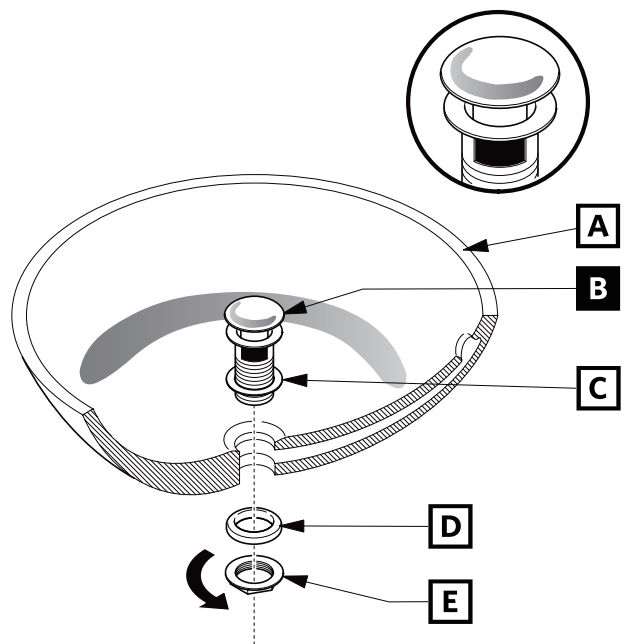

P-TRAP INSTALLATION

1 Install tail pipe (G)

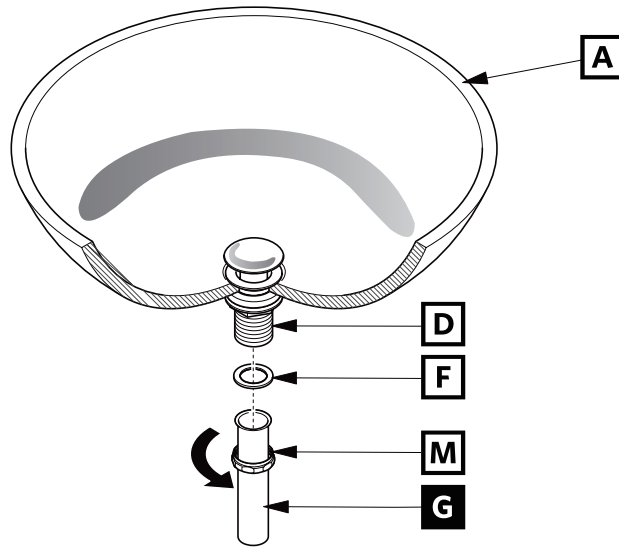

2 Install P-trap (J)

