

# SK642

## WIRELESS WATER ALARM SYSTEM WITH AUTO DIALER

### OWNER'S MANUAL AND SET UP INSTRUCTIONS.

Thank you for choosing Ideal Security's Wireless Water Alarm with Telephone Dialer. Please read through complete instructions before installing units. If you have any questions, problems or comments regarding the installation or operation of this system, please do not hesitate to contact IDEAL's customer service department through our web site at [www.idealalert.ca](http://www.idealalert.ca), via email at [info@idealalert.ca](mailto:info@idealalert.ca), or by calling our toll free number at 800-361-2236 x 230. Normal business hours 7:30am to 3:00pm Eastern time. Monday to Friday.

You can add up to 22 additional Ideal Security wireless detectors, to this system. i.e. motion detectors, door and window contacts, temperature detectors, additional water detectors, and up to 8 remote controls.

Occasionally instructions have errors or omissions, please check for updates to these instructions, security tips and other valuable information at [www.idealalert.ca](http://www.idealalert.ca)

*Before permanently installing either device in this package please test the range to make sure that the receiver picks up the sensor. Range between the auto dialer and water detector is 30-60 meters (98-196 feet) However floor levels and steel structures may reduce this.*

**THE TELEPHONE DIALER REQUIRES A LAND TELEPHONE LINE TO MAKE OUTGOING CALLS AND ELECTRICITY.**

#### **Important note:**

### **REGARDING AUTO DIALER, ANSWERING MACHINES & REMOTE COMMUNICATION.**

“REMOTE ACTIVATION” allows user to call into the telephone dialer to perform the following functions:

- Activate the system
- De-Activate the system
- Listen in to the room containing the auto dialer.

#### **ANSWERING MACHINE SETTING AND REMOTE ACTIVATION**

If the “REMOTE ACTIVATION” feature is required, the response setting must be changed to allow for the auto dialer to respond before the answering machine

Depending on your specific needs, priority must be given to either the answering machine or “REMOTE ACTIVATION”

If you intend to use the “**REMOTE ACTIVATION**” features (controlling the alarm unit remotely), you cannot use an answering machine in the usual way.

To use the remote activation feature: Set the auto dialer to respond (pick up) before your answering machine responds. For example, if your answering machine is set to pick up after 5 rings then set the auto dialer to pick up after 3 rings, this way your **AUTO DIALER** will pick up first, allowing you to enter your *key* selection. Complete instructions on setting up the remote activation follow.

If the answering machine is required, then the remote activation feature cannot be used. Set the auto dialer to respond **after** your answering machine normally responds (set it to 10 rings) this will ensure that the answering machine is the first response.

## INTRODUCTION

Our unique Wireless Water Alarm System with Auto dialer will provide you with early warning which may reduce the risk of water damages. Choose a location where water leaks or infiltration may occur to install the wireless water sensor, and a desired location for the auto-dialer, (near electrical outlet and telephone jack) set the auto-dialer at **ARM** mode. Once water is detected, the auto-dialer will turn on the built-in siren (optional) and dial out the pre-programmed telephone numbers one by one, for the pre-programmed cycles. You can set the auto-dialer to **HOME** mode, you will hear one chime only when water is detected and the zone 1 will flash on the display screen. The screen will reset itself after 5 minutes. System will not dial out.

## IMPORTANT SAFETY TIPS

1. Do not install the system where it will be exposed to direct sunlight or rain.
2. The built-in siren is very loud, never put the system close to your ear.
3. The system should be installed away from heat sources such as radiators, heating ducts and stoves.
4. If the system sounds at random, it is possible that the installed location is too close to a heat source, changing the location or direction of the unit can correct the problem.
5. The system will provide early warning protection for your home and property from water damage if you use it properly. However, this system cannot guarantee protection against water damages. Ideal will not be responsible for any losses or damages occurred during use of this product.

## DESCRIPTION OF COMPONENTS

1. Antenna Jack
2. Telephone LINE Jack
3. Antenna (antenna is fixed do not try to remove)
4. Battery Low LED
5. Ex Power LED
6. LCD Display
7. Numerical Keys

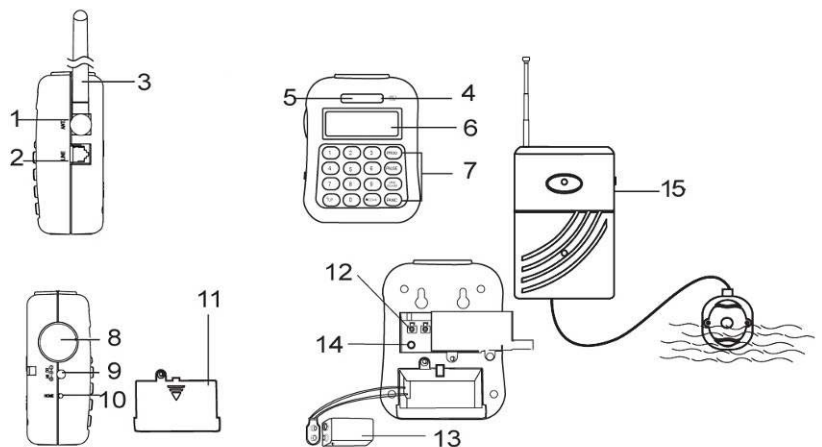

8. Buzzer (built-in siren)
9. DC 9V Jack
10. HOME on/off Switch
11. Battery Cover
12. External Trigger Input Terminal
13. 9V Battery
14. RESET button
15. Wireless Water Overflow Sensor

## FEATURES

- The water detector included in this package has been pre-learned to **zone 1**. You may change this by following the learn instructions further in this manual.
- Wireless Water Sensor, detects water and sends out RF signal to auto-dialer, and activates built-in siren in both the auto dialer and water detector if on. (optional)
- 16 Digit large number display with date/time and function icon.
- 10 zone icon for easy differentiation of sensor locations.
  - **Zones 1 to Zone 7:** Learn one wireless sensor to each zone to trigger the system (In ARM mode only)
  - **Zone 8S:** Learn up to 8 wireless sensors to trigger the system (In ARM mode only)
  - **Zone 24H** (24 hours stand by): Learn up to 8 wireless sensors to trigger the system in ARM or DISARM mode.
  - **Remote zone:** Learn and connect up to 8 remote controls.
- Room monitor by telephone function.(listen to room activity following alarm)
- ARM or DISARM system by telephone.
- Programmable password, entry delay timing (set time for how long after trigger before the auto dialer will dial out and siren will sound)
- Up to 5 emergency telephone numbers (up to 32 digits each) (only last 16 digits appear on LCD screen)
- Programmable auto dialing cycle (how many times the auto dialer will dial each programmed number)
- Records up to five triggered alarms for alarm mode.
- Built-in flash memory to protect system data during a power failure. If you have a power failure and the battery dies, all info will remain in auto dialer except the date and time. We recommend that the battery in the dialer be changed at least once per year, as you change your smoke detector battery.
- Battery Low indicator.
- Tone dialing only.
- HOME mode function (auto dialer will chime when sensors are triggered instead of siren sound)
- Auto-dialer has optional built-in 105 dB alarm (with programmable ON/OFF alarm)
- External extend trigger input terminal (to connect Ideal's wired window and door contacts SK619)
- AC adaptor and 9V battery back-up (included)

- Wall mountable (screws and anchors included)
- Water Detector with built in 105 dB alarm.(optional)

## INSTALLATION

Unit must be installed where it has access to a land line and electrical outlet.

1. Remove the screw from battery cover of main unit, install 9V battery. This is a back-up battery. This battery will keep the unit working in case of power failure. (Fig.1) Also install 9V battery in the water detector (Fig.2.)

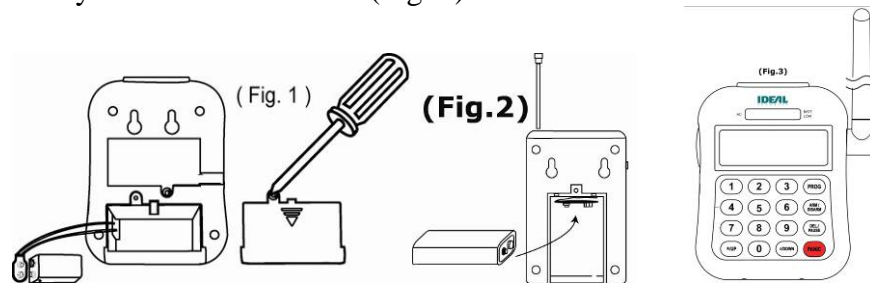

2. Raise the antenna on the side of the auto dialer and raise the antenna of the water detector unit so it points up. (Fig.2&3) The antennas should be vertical for best reception.

## WIRELESS WATER SENSOR

There are two parts in the sensor, the main unit and the sensor probe.

### INSTALLATION (test range before permanently installing)

- a. Mount the main unit at a desired location with hardware included.
- b. Mount the sensor probe at desired location using its suction cup. (Fig.2)

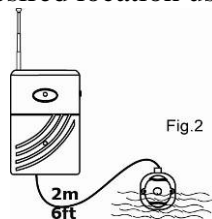

## OPERATION

- a. The sensor is in standby mode once battery is installed.
- b. The LED will flash and the siren will sound for 45 seconds once water is detected. Slide the alarm switch to ON/OFF position for siren sound ON/OFF as desired. If in OFF position the unit will still send signal to auto dialer if triggered, the unit itself will not sound. ON/OFF switch is for internal alarm sound only.

3. The supplied telephone line splitter can be installed into your telephone wall socket. (Fig.3a) or the LINE Jack of the auto-dialer (Fig.3b)
4. Using the telephone wire supplied, insert the small clear plug into the LINE jack on the auto-dialer and the other end into the telephone line splitter, (Fig.3a) or insert your telephone line splitter into LINE Jack of main unit, then plug telephone wire supplied into wall socket. (Fig.3b)

5. Your existing telephone line can now be inserted into the telephone line splitter. (Fig.3a/b)
6. Connect the AC adaptor to the DC 9V jack on the auto-dialer. (Fig. 3c)

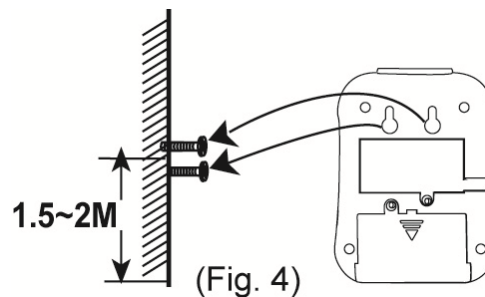
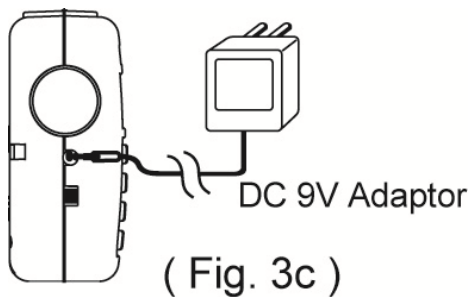
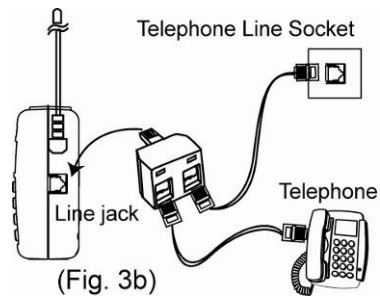
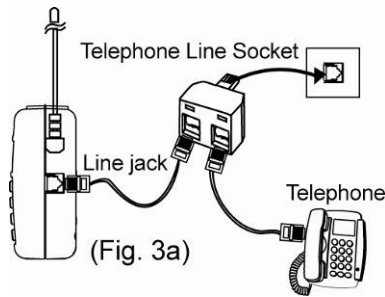

7. Wall mount option: **Check range of both units before permanently installing.** Choose a suitable location, drill holes and install anchors and screws. Place the auto-dialer over the screws and slide it down to secure it in place (fig 4).

### SYSTEM AUTO-DIALER SET-UP



During any set-up, if no key is pressed for 10 seconds, the auto-dialer will automatically exit set-up mode.

- All set-ups must be done in **DISARM** mode only. (the word **ARM** will not appear on the screen)
- Your auto-dialer has a factory preset password of 0-0-0. This can be changed to your own personal password.





### 1. TO SET PASSWORD

- a. Enter factory pre-set password 0-0-0. Press **PROG** PROG button once (1), **PASSWORD** will flash on the auto-dialer screen. (Fig.5)







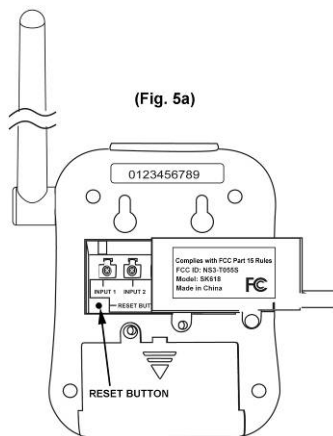



- b. Press the **ARM/DISARM**  button to confirm that you want to enter the PASSWORD.
- c. Enter your new password then press the **ARM/DISARM**  button to confirm (you can choose from 3 to 6 digits for your password).
- d. Record new password here: \_\_\_\_\_
- e. Press the **PROG**  button nine (9) times to exit set-up mode.

### NOTE: PASSWORD RESET

If you forget your password, open back of unit and locate the **RESET** button (Fig.5a). Press and **hold** the **PROG**  button, **and**, press and release the **RESET** button once. The screen will go blank. When screen returns let go of the **PROG**  button. You now have the factory pre-set password of 0-0-0. This will reset the password **ONLY**, all other information will remain (programmed telephone numbers and learned sensors)









## 2. REAL TIME SETTING (YEAR / MONTH / DATE / HOUR / MINUTES)

- a. Enter password followed by **PROG**  button nine (9) times.
- b.  will flash on the auto-dialer screen.
- c. Press **ARM/DISARM**  button to confirm.
- d. The date will show on the auto-dialer screen as five sets of numbers: year, month, and date followed by the time, hour and minutes (24hr time clock). The first set of numbers will flash confirming that these can now be changed.
- e. Enter correct year by pressing **\*/UP**  or **#/DOWN**  button, then press the **ARM/DISARM**  button. The next set of numbers will start flashing, enter the month by pressing **\*/UP**  or **#/DOWN**  button, then press the button **ARM/DISARM** , and so on until all numbers have been entered. You will now have the correct date and time.
- f. Press **PROG**  button once (1) to exit set-up mode.

## 3. TO PROGRAM EMERGENCY TELEPHONE NUMBERS

All stored telephone numbers will be dialed, in sequence, the complete amount of cycles programmed. For example if you program 5 telephone numbers and set the cycle to 2, all 5 phone numbers will be dialed twice regardless if one of the calls is answered or not. Do





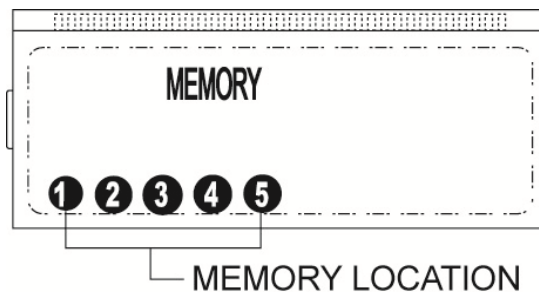

not enter your own home phone number, as the auto dialer uses your phone line to dial, it will not work. You must also enter complete phone numbers including area codes, and if long distance, include the 1.

- a. Enter password followed by **PROG**  button twice (2).
- b. **MEMORY** will flash on the auto-dialer screen. (Fig.6)
- c. Press **ARM/DISARM**  button to confirm.
- d. You are now ready to program up to 5 emergency telephone numbers. Press the **\*/UP**  or **#/DOWN**  buttons to select memory location from 1 to 5. The numbers will be dialed in the number sequence that they are entered.
- e. Enter the telephone number you would like to store, followed by **ARM/DISARM**  to confirm (maximum of 32 digits, but only displays last 16 digits).
- f. Repeat steps **c** to **e** for the four other numbers you may wish to store.
- g. Press **PROG**  button eight (8) times to exit the set-up mode.









(Fig.6)

#### 4. TO DELETE A TELEPHONE NUMBERS FROM MEMORY

- a. Enter password followed by **PROG**  button twice (2).
- b. **MEMORY** will flash on the auto-dialer screen. (Fig.6)
- c. Press **ARM/DISARM**  button to confirm.
- d. Press **\*/UP**  or **#/DOWN**  buttons to select the number you want to delete.
- e. Press **DEL./PAUSE**  button to delete the number.
- f. Press the **ARM/DISARM**  button to confirm.
- g. Press **PROG**  button eight (8) times to exit the set-up mode.

#### 5. PAUSE FUNCTION

The "PAUSE" function can be stored as one digit in the telephone number memory for some dialing operations. Every one PAUSE in the memory dialing sequence will pause for 3.6 seconds. For example, if you want to store telephone number 514-363-1030 EXTENSION 230 to a memory location, the operation will be as follows:

- a. Enter password then press **PROG**  button twice (2).
- b. **MEMORY** will flash on the auto-dialer screen.
- c. Press **ARM/DISARM**  button to confirm.
- d. Press **\*/UP**  or **#/DOWN**  button to select a memory location.
- e. Enter 5143631030 **DEL./PAUSE**  (hold for 2 seconds until the letter **F** appears on the screen, then enter 230).
- f. Press **ARM/DISARM**  button to confirm.



- g. Press **PROG**<sup>(PROG)</sup> button eight (8) times to exit set-up mode.

## 6. TO PROGRAM SIREN ON/OFF

The auto-dialer has been factory pre-set with the siren ON. To turn the siren OFF:

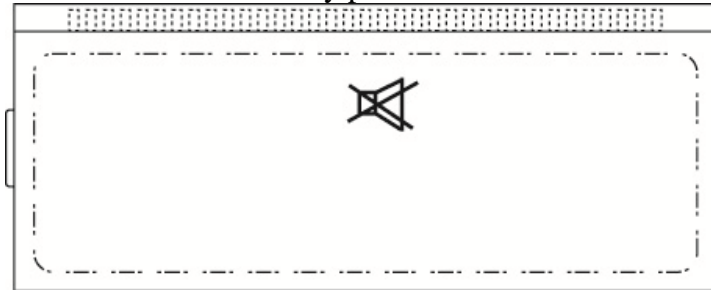

(Fig.7)

- Enter password followed by **PROG**<sup>(PROG)</sup> button four (4) times.
- The "  " icon will flash on the auto-dialer screen. (Fig.7)
- Press **ARM/DISARM**<sup>(ARM/DISARM)</sup> to confirm.
- Using **\*/UP**<sup>(\*/UP)</sup> or **#/DOWN**<sup>(#/DOWN)</sup> buttons to select SOUND OFF. Followed by **ARM/DISARM**<sup>(ARM/DISARM)</sup> button to confirm.
- Press **PROG**<sup>(PROG)</sup> button six (6) times to exit the set-up mode.

## 7. TO PROGRAM AUTO CALL FUNCTION ON/OFF

The auto-dialer has been factory pre-set with the call option ON. If you do not want the auto dialer to call out change this to OFF:

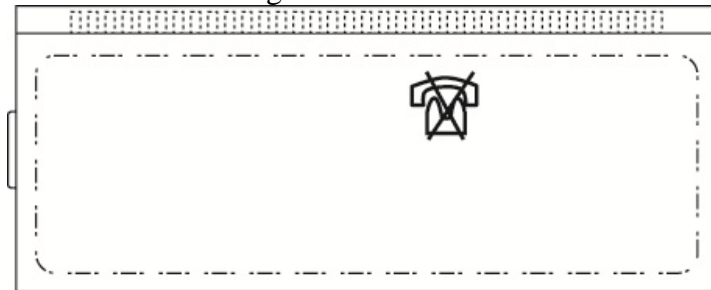

(Fig.8)





- Enter password followed by **PROG**<sup>(PROG)</sup> button five (5) times.
- The "  " icon will flash on the auto-dialer screen. (Fig.8)
- Press **ARM/DISARM**<sup>(ARM/DISARM)</sup> button to confirm.
- Using **\*/UP**<sup>(\*/UP)</sup> or **#/DOWN**<sup>(#/DOWN)</sup> buttons to select call OFF followed by the **ARM/DISARM**<sup>(ARM/DISARM)</sup> button to confirm.
- Press **PROG**<sup>(PROG)</sup> button five (5) times to exit the set-up mode.

## 8. TO PROGRAM AUTO DIALING CYCLE

The auto-dialer has been factory pre-set for auto dialing for 3 cycles (When water is detected the auto dialer will call **ALL** stored numbers 3 times). You can change this cycle from 1 to 5 dialing cycles.

- Enter password followed by **PROG**<sup>(PROG)</sup> button six (6) times.









- b. CYCLE will flash on the auto-dialer screen.
- c. Press **ARM/DISARM**  button to confirm.
- d. Using **\*/UP**  and **#/DOWN**  buttons to select cycle times between 1 and 5 followed by the **ARM/DISARM**  button to confirm.
- e. Press **PROG**  button four (4) times to exit set up mode.

This receiver/auto-dialer permits the person receiving an alarm call to listen-in to the room where the dialer is located, or to call into the residence and listen.

### 9. TO PROGRAM CALL-IN RING DETECT CYCLE (how many rings before auto dialer will answer).

The auto dialer has been factory preset to answer on the 5<sup>th</sup> ring.







The call-in ring detect cycle is for how many times you want the phone to ring before the auto-dialer picks up. You can **ARM/DISARM** and monitor your home via the telephone.

- a. Enter the password followed by the **PROG**  button seven (7) times.
- b. A  will flash on the screen.
- c. Press **ARM/DISARM**  button to confirm.
- d. Using the **\*/UP**  and **#/DOWN**  buttons select 3, 5, 7 or 10 (which represents the # of rings before the auto dialer picks up) followed by the **ARM/DISARM**  button to confirm.
- e. Press the **PROG**  button three (3) times to exit set-up mode.

**NOTE: Regarding answering machines and call in feature.** You cannot use an answering machine with this feature. If you want to be able to call in to the auto dialer you must program it to answer before your answering machine does. Example if your answering machine answers after 4 rings, you must set the auto dialer to answer at 3 rings.

### 10. TO PROGRAM ENTRY DELAY TIME (Amount of time you need to deactivate system once you have entered your residence)

The auto dialer has a factory preset entry delay of 20 seconds

- a. Enter password followed by **PROG**  button eight (8) times.
- b. ENTRY will flash on the auto-dialer screen.
- c. Press the **ARM/DISARM**  button to confirm.
- d. Using the **\*/UP**  and **#/DOWN**  buttons select the seconds 0,5,10,15 or 20. Press **ARM/DISARM**  to confirm the number of seconds you require for the entry delay time.
- e. Press the **PROG**  button twice (2) to exit set-up mode.

### 11. TO TEST MEMORY DIALLING

In standby mode, (the word **ARM** does not appear on the screen) press and hold the **PROG**  button for at least 3 seconds, you will hear a short beep. Key in the memory location of the telephone number, i.e. 1 – 5. The telephone number stored in

specified memory location will automatically be dialed. Press the **PROG** PROG button to stop the dialing. The auto dialer must be connected to a land line in order for this function to work. If not connected, then you will hear 4 short beeps.

## 12. TO TEST THE WIRELESS SENSOR TRANSMITTING RANGE

After selecting a location for the units, but before installing permanently, you should test the signal range of all units. Press the **HOME** button on the left side of the auto-dialer, **wait 60 seconds** at which time you will hear a beep. Then trigger the water detectors. The auto-dialer will receive a signal and a chime will sound. If you do not hear a chime and the zone is not flashing on the auto-dialer screen, the water detector may be out of range of the auto-dialer. Repositioning either the sensor or auto-dialer should fix this problem. Press **HOME** button again to exit test mode.

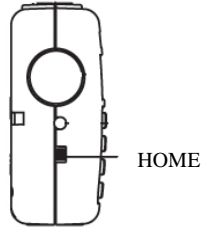

## OPERATION



### 1. TO ARM THE SYSTEM

- Enter password followed by the **ARM/DISARM** ARM/DISARM button.
- Three short beeps will sound and the ARM icon will show on the auto-dialer screen.
- You can also press the **ARM**  button on the remote control unit (SK629 sold separately) to ARM the auto dialer. (if learned)
- Wait 60 seconds** for a short beep. The auto-dialer is now set at ARM and ready to receive signals.
- When the system is armed (ARM), if you have installed and learned a door or window detector and if a door or window is open the auto dialer will beep for 5 seconds and the screen will show "CLOSE PLEASE" and also indicate the zone number. If the door or window is still not closed it will start dialing after 60 seconds.

### 2. ALARM

- If the auto-dialer (in ARM mode) receives a signal from the water detector, the screen will display **TRIGGER** with the zone number 1. If the auto-dialer (in ARM mode) receives a signal from *any* sensor, the screen will display **TRIGGER** with the zone number. After the delay entry time it will sound a SIREN for 30 seconds on, 30 seconds off and 30 seconds on, and will automatically dial all the numbers stored, one by one, for the CYCLE (amount of times the numbers are dialed) you have chosen. The receiver of the phone call will hear **one beep cycle for zones 1-7 and 8S, two beep cycles for 24hr zone and four beep cycles for PANIC**. The receiver of the call can then call a neighbor, or take other appropriate action.
- In ARM mode, if the auto-dialer is set to **SIREN OFF**, the numbers stored will be dialed silently. No siren will be heard from the installed location. When the call is answered you will hear the sequence of beeps and know which zone was triggered.

### 3. TO DISARM THE SYSTEM

- a. Enter password followed by the ARM/DISARM  button on the auto dialer. Or press on **DISARM**  button on the remote. (if learned)
- b. You will hear one beep and the ARM icon will disappear from the auto-dialer screen to confirm that the Auto-Dialer has been DISARMED.

**NOTE:** In the 24HR zone, the sensors will trigger the auto-dialer in ARM or DISARM mode and start dialing the stored numbers the amount of times programmed immediately and the siren will sound. If siren is set to OFF the unit will beep 4 times. Before dialing, the auto dialer will detect if a phone line is connected, if no telephone line is connected the auto dialer will beep 4 times then the alarm will sound without dialing.

#### 4. HOME MODE FUNCTION:

While at home you can set your auto-dialer to home mode. This will activate a chime every time a sensor is triggered. If you have installed additional sensors you can also program which zone will send signal to auto-dialer when triggered. The factory default is all sensors send signal.

##### Turn system to Home Mode.





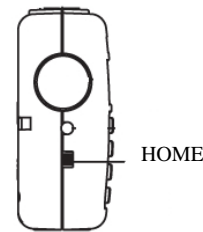

- a. Press the **HOME** button once; (on left side of auto-dialer) you will hear a chime and the word **HOME** will appear on the LCD screen.
- b. Wait 60 seconds, you will hear a beep. System is now in home mode and will chime if sensor is triggered.
- c. When auto-dialer receives signal from zones 1-7 & 8S it will chime and show which zone is being triggered on the auto-dialer LCD screen. After 5 minutes it will reset itself and **TRIGGER** will disappear from the screen. If 24hr or panic zones are triggered the auto dialer will start dialing the numbers programmed for the amount of times specified if telephone line is detected. The auto dialer will not reset itself it will keep showing the trigger until you press the **HOME** button.
- d. Press the **HOME** button again to exit the **HOME** mode.

**NOTE: Arming system while in HOME mode will deactivate HOME mode. After disarming system you will have to press the HOME button again if you want to return to HOME mode. In HOME mode the only thing the system does not do is dial out or sound alarm for zones 1-7 and 8S. For zones 24hr and REMOTE when triggered they will dial out.**





##### Enabling and Disabling sensors when in HOME mode.

When in HOME mode all sensors will send signal to auto dialer and you will hear a chime when a sensor is triggered. If you have one or more sensors that you do not wish to have them send a signal to the auto dialer, example a contact on a patio door that is in zone 3, then you would disable zone 3. Zone's 1-7 can be disabled. All sensors in zone 8S must be enabled or disabled together. They cannot be separated. Zones **24hr** and **REMOTE** cannot be disabled. Factory setting is for all sensors on and will activate chime when triggered. To turn off a zone follow these instructions.



- a. Enter password followed by pressing the Home button.
- b. Zone one will flash on the LED screen.
- c. Using the **\*/UP**  and **#/DOWN**  buttons select the zone you want to change the setting for.
- d. Press **ARM/DISARM**  button to confirm. Then using the **\*/UP**  & **#/DOWN**  buttons select ON or OFF. Press **ARM/DISARM**  button to confirm.
- e. Press the Home button once to exit home-setup.

## 5. PANIC BUTTON

- a. If you press "**PANIC**"  button on the auto-dialer or remote control , (if learned) the ALARM will sound instantly for 30 seconds, then off for 30 seconds, then on for 30 seconds and then off, and the auto-dialer will begin dialing the stored numbers immediately, in either ARM or DISARM mode. If siren is set to OFF you will hear 4 short beeps at the auto dialer and it will start dialing.
- b. To stop the alarm sound and the dialing, enter password then press **ARM/DISARM**  button or press the **DISARM**  button on the remote.

## 6. REMOTE CONTROL BY TELEPHONE OPERATION. (What you can do when you receive a call from the system)

How to respond to a telephone alarm call.

- a. Answer the call. You will hear one of the following:
  - 1) 1 beep cycles is for zones 1-7 and 8S
  - 2) 2 beeps cycles is for zone 24hr
  - 3) 4 beeps cycles is for PANIC
- b. You may enter the following codes on your phone key pad. Once code is entered you will hear a beep for confirmation.

<u>Function</u>	<u>Press Keys</u>
▪ To Monitor Room	1#
▪ To End the Call	3#
▪ To DISARM the System	6#

## 7. REMOTE CONTROL BY TELEPHONE TO CONTROL ALARM (To control your auto dialer via telephone) (see ANSWERING MACHINES and REMOTE COMMUNICATION)

- a. Dial your home number (from another line). The auto-dialer will answer after the designated amount of rings that you have programmed.
- b. Once answered enter your PASSWORD, you will hear two beeps (confirmation).
- c. Enter key combination listed below for desired function you would like to perform.

<u>Function</u>	<u>Press Keys</u>
▪ To Monitor Room	1#



**The water detector included in this package has already been learned to the auto dialer in zone 1.** You may learn additional sensors to your auto-dialer or you can move the water detector to another zone, and at some time you may have to re-learn existing parts.

The system has a total of 10 on screen zones for wireless sensors and remote controls.

**Zone 1-7:** Learn up to 7 wireless sensors, and they will trigger the dialer in armed mode only.

**Zone 8S:** Learn up to 8 wireless sensors and they will trigger the dialer in armed mode only.





**Zone 24H** (24H standby mode): Learn 8 wireless sensors and they will trigger the auto dialer in armed or disarmed mode.

**Zone REMOTE** (LCD icon REMOTE) is the remote control zone and you can learn up to 8 remote controls. (Ideal Security part # SK629 ONLY)

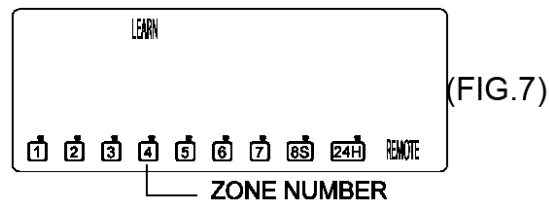
You can learn a total of 23 sensors and 8 remote controls to this unit.

Each new sensor or remote must be learned to the auto dialer. Follow the following steps.



- a. Enter your password and press the **PROG** button three (3) times.
- b. The “LEARN” icon will flash on the screen. (FIG.7)
- c. Press **ARM/DISARM**  to confirm, the system will go into learning ID code mode and zone 1 icon will flash
- d. Press the **\*/UP**  and **#/DOWN**  buttons to select the zone you wish to learn your sensor to. When the screen flashes NO ID CODE, that means that zone is empty and you can learn a sensor. If the screen flashes FULL then you already have a sensor learned to that zone. You can either choose another zone or press **DEL./PAUSE**  to delete the sensor in that zone and learn the new sensor.
- e. Press **ARM/DISARM**  to confirm that this is the zone you want the sensor to be.
- f. **Trigger** the sensor or remote control that you are trying to learn as follows:
  1. Wireless motion detector SK615, by moving hand in front of sensor to send signal.\* *please see NOTE below*
  2. Wireless door/window sensor SK621 & SK625, opening and closing the magnetic switch will send signal.
  3. Wireless water alarm sensor SK616, put sensor in water to trigger and send signal.
  4. Wireless temperature sensor SK627, by pressing the test button.
  5. Remote control SK629, pressing any key will trigger and send a signal.
  6. Garage Alert SK623, opening the garage door will trigger and send signal.

- g. You will hear a long beep from the auto-dialer to confirm that learn was successful and the screen will display FULL for that zone.
- h. Press the **PROG**  button seven (7) times to exit the setup mode.

**NOTE:** if you have learned a motion detector to your auto dialer, place a towel over the motion sensor before learning other items as the motion sensor will send signal to auto-dialer every time you move.

### **LEARN AUTO DIALER TO SEND SIGNAL TO WIRELESS SIREN (SK626) OR AC OUTLET CONTROL (SK635) WHEN TRIGGERED.**

When the auto-dialer is triggered you may want it to send a signal to either a siren or an AC outlet control (will turn on an appliance that is plugged into it)

#### **SK626 SIREN (Full instructions are available in the SK626 package & also at [www.idealalert.ca](http://www.idealalert.ca))**

- a. Open the battery cover on the back of the siren. Use a pen to press and hold down the **LEARN** button for 2 seconds, you will hear a beep. Release the button. The unit is now ready to receive the learn ID code signal from the auto dialer.
- b. Trigger the auto dialer by pressing on the panic button.
- c. Once learn code was successful you must **ARM** the siren in order to receive the signal from the auto-dialer. There will be a **60 second** delay at which time you will hear a beep. Now it will be ready to receive signal.

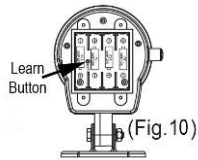

#### **SK635 AC OUTLET CONTROL**

- 1. Press and hold the **ON/OFF/LEARN** button on front of unit for 2 seconds until you hear a beep. Now the unit is ready to learn signal.
- 2. Trigger the auto dialer by pressing on the panic button.
- 3. Once learn code was successful you must turn **ON** the AC Outlet Control in order to receive the signal from the auto-dialer.

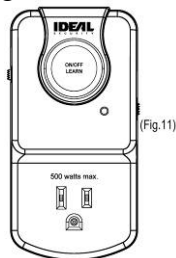

**NOTE:** You will hear a long beep to confirm that the learn code was successful. When learn code is not successful you will hear 4 short beeps. If this happens please re-learn again.



## TROUBLE SHOOTING GUIDE

### 1. AUTO-DIALER WILL NOT ARM/DISARM

- a. Make sure you have entered the correct password, if not, re-enter the password.
- b. If it still does not work, perform the **password reset** following the instructions in the “CHANGE PASSWORD” section to reset the auto-dialer.
- c. Retry the ARM/DISARM function.

### 2. UNIT WILL NOT DIAL

- a. Make sure the telephone line is connected properly.
- b. Make sure the telephone numbers are stored correctly, include area code and 1 if long distance.
- c. Make sure you have not entered your home number where the auto-dialer is set up.
- d. Make sure the auto-dialer is setup for auto-dial mode.
- e. If auto-dialer does not receive a signal from the wireless sensor, perform the **learn code** function following the instruction in the “LEARN CODE FUNCTION FOR WIRELESS SENSORS” section.

### 3. FALSE TRIGGER

If any sensor sends false signals, ensure that the batteries are still in good operating condition. Make sure that the gaps between the contact and sensor on the window and door contacts are no more than a ¼” apart and that arrows are pointing towards each other. Water detector is not in direct contact with some moisture or excess humidity.

### TIPS

1. Make sure the full telephone number including area code has been entered correctly.
2. Only suitable for single phone line. Not compatible with fax machines or multi line telephones.

### WARNING

All batteries including the back up battery in the telephone dialer should be changed once per year. Should a power failure occur and the back up battery is weak, or batteries in all your sensors are weak, false alarms may occur. If the telephone dialer or any other detector is not being used for an extended period, remove the batteries to avoid any damage due to battery leakage.

**NOTE:** Please preserve this manual. It contains valuable information for properly setting up and operating the system. Please check for updated instructions at [www.idealalert.ca](http://www.idealalert.ca)

***Thank you for your purchase: If you have any questions about setup or function of this product, please call us at 800-361-2236 x230(514-363-1030) before returning to the point of purchase. Perhaps we can resolve your difficulty and eliminate future customer dissatisfaction.***

e-mail: [info@idealalert.ca](mailto:info@idealalert.ca)

[www.idealalert.ca](http://www.idealalert.ca)

