

# Pergo® Installation Essentials Guide For Laminate Flooring



SECTION

---

- 1. Floating Floor—Definition & Benefits
- 2. What You Need To Know—Expansion/Contraction
- 3. Before Starting—Estimates
- 4. A Basic Overview
- 5. Installation Requirements
- 6. Job Site Evaluation—Exterior/Interior moisture conditions
- 7. Subfloor Requirements—General
- 8. Wood Subfloor Requirements
- 9. Concrete Subfloor Requirements

SECTION

---

- 10. Other Subfloor Requirements
- 11. New Construction Requirements
- 12. Bathroom Installation
- 13. Kitchen Installation
- 14. Laundry Room Installation
- 15. Radiant Floor Heating
- 16. Homes or Rooms without Climate Control
- 17. Commercial Applications
- 18. Installing Pergo Stair Nosing

For questions regarding this installation information, you can call  
1-800-PERGO (1-800-337-3746).

**1. FLOATING FLOOR**—Pergo flooring is designed to be installed as a floating floor—thus it is not nailed or glued to the subfloor. Instead, planks are fastened together utilizing unique tongues and grooves to create a durable, easy-to-maintain floor surface. Because Pergo flooring expands and contracts with temperature/humidity changes—it is essential that a  $\frac{3}{8}$ " expansion space be left around the floor's perimeter. Depending on the type of Pergo flooring you purchased and your home's subfloor type, you may also be required to install a sound underlayment and/or 6-mil. (.15mm) non-recycled (100% virgin) resin polyethylene film as a moisture barrier beneath your Pergo floor. Please refer to the detailed installation instructions by subfloor type that follow. The illustrated example below shows Pergo being installed over a concrete subfloor.

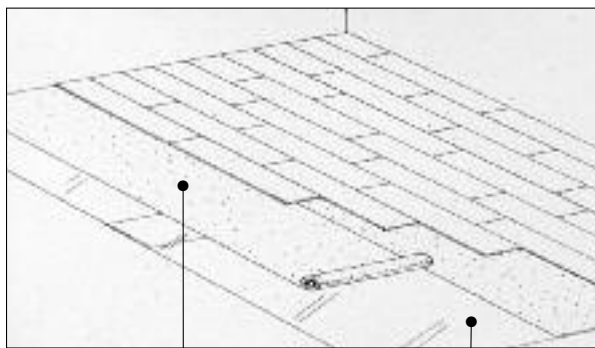

Pergo SilentStep™ Foam or Soundbloc™ Foam to be used with flooring that doesn't have attached underlayment.

Vapor barrier over concrete - Moisturbloc™

**2. WHAT YOU NEED TO KNOW**—Pergo flooring consists of planks made from a durable laminate surface, a wood based core and a balancing backing. The planks are clicked together to form a long lasting, easy-to-maintain surface. Like almost all materials in the home, Pergo flooring expands and contracts due to changes in temperature and humidity. You must allow unopened cartons of Pergo flooring to lay flat in the room where they will be installed to acclimate for 48-96 hours, depending upon climate, before beginning installation. A  $\frac{3}{8}$ " expansion space must be left around the perimeter of the floor to allow for movement. Failure to meet these requirements can result in the flooring buckling.

Pergo flooring is a complete flooring system that includes a wide range of coordinating moldings and transition strips designed to cover the  $\frac{3}{8}$ " expansion space at the walls, doorways and transitions to other flooring. Specialized tools, required to properly install Pergo flooring, are available where Pergo products are sold.

**3. BEFORE STARTING**—Before beginning a Pergo installation project, it is critical that you 1) fully acquaint yourself with the detailed installation instructions for your specific flooring and subfloor type and 2) conduct a complete job site evaluation (see section 6, Job Site Evaluation).

- a. For appropriate installation information, review this guide and the assembly instructions printed on or provided within each carton for the Pergo flooring type you purchased. If you prefer to speak to a person regarding installation, call 1-800-33-PERGO (1-800-337-3746).

- b. Make a complete job site evaluation (see section 6, Job Site Evaluation) to assure that environmental conditions are acceptable for installing Pergo flooring.
- c. Determine the quantity of Pergo planks, flooring transitions and wall trim needed for your installation. Depending on the type of Pergo flooring purchased, the type of room and the type of subfloor you are working with, you may also need glue, sealant, a 6 mil (.15mm) non-recycled (100% virgin) resin polyethylene film as a moisture barrier and/or sound underlayment designed for laminate floors (see detailed installation instructions). Add 10% to your square footage for standard installations. For diagonal installations, add 15%.
- d. Make sure you have the appropriate installation tools, an Installation Kit, additional spacers (used to maintain expansion space).
- e. Acclimation—Allow unopened cartons of Pergo planks to lay flat in the room where they will be installed for 48-96 hours, depending upon climate, before beginning installation. During this time, the planks adjust to the specific temperature and humidity conditions of the room.

#### 4. A BASIC OVERVIEW

- a. Remove any existing quarter round molding. The existing quarter round can be repainted and installed after the Pergo installation or you can select a new, finished, color-coordinated Pergo quarter round available at your retailer.
- b. Always remove carpet, pad and tack strips.
- c. Remove wood flooring if it is installed over a concrete subfloor.
- d. Be sure the surface of the subfloor is flat, clean, dry and sound before starting. (Refer to Subfloor Requirements Sections 7, 8, 9, 10 & 11.)
- e. On concrete subfloors, use a non-recycled 6-mil. (.15mm) non-recycled (100% virgin) resin polyethylene film as a vapor barrier, overlapping edges 8", or follow the directions for installation of an equivalent vapor barrier.
- f. Use Pergo SilentStep™ or Soundbloc™ Foam or equivalent foam underlayment to absorb sound and to make the floor more comfortable to walk and stand on when the Pergo product that you are using does not have an attached underlayment foam. Do not install Pergo over multiple layers of acoustic underlayment.
- g. Inspect every plank for any shipping damage when removing from the carton.

#### 5. INSTALLATION REQUIREMENTS

- a. Pergo is intended only for indoor use.
- b. Acclimation—Allow the Pergo planks to lay flat in unopened cartons, at least two feet from walls where they will be installed, for 48-96 hours before starting the installation. In very dry or very humid climates, allow at least 96 hours (4 days). For acclimation before, during and after the installation at the job site, the relative humidity should be 30-90%. The temperature should be at least 65°F for product acclimation and at least 65°F two days after installation.

- c. Pergo must be installed as a floating floor and must not be fixed to the subfloor. A  $\frac{3}{8}$ " expansion space must be provided around the perimeter of the room and any fixed objects such as pipes or columns. Door jambs and casings must be undercut. The Pergo flooring must be placed at least a  $\frac{3}{8}$ " beneath the undercut jambs and casings. A  $\frac{3}{8}$ " expansion space must also be included beneath the undercut jambs and casings. Areas greater than 40 feet in length or width require a  $\frac{1}{2}$ " expansion space around the perimeter of the room and all fixed objects.

Areas greater than 40 feet in length or width, i.e. (one room; two or more rooms with adjoining archways greater than 4 feet; large room with an extended hallway) must have a T-molding installed across the width of the room, archway or at the beginning of the hallway to provide additional expansion space. Doorways of less than 4 feet must *always* have a T-molding or other transition molding *regardless of floor length or width*.

- d. Pergo can be installed above, on or below grade, however, below grade must not have a sump pump.
- e. Pergo planks are installed over Pergo SilentStep™ or Soundbloc™ foam or equivalent foam underlayment when the Pergo product that you are installing does not have an attached underlayment foam. When installing over concrete, an additional underlayment, Pergo Moisturbloc™, a 6-mil. (.15mm) non-recycled (100% virgin) resin polyethylene vapor barrier or an equivalent non-recycled 6-mil. polyethylene vapor barrier, is required for all Pergo products.
- f. Use approved safety equipment to provide proper protection based on each given task. Always be careful when handling the planks as the cut edge of the laminate can be sharp.
- g. Important—Always inspect each plank to make sure it is not damaged prior to installation.

**6. JOB SITE EVALUATION**—Exterior conditions and how they can influence the interior of a home.

- a. Building codes are established to provide a safe living space. There are nationally recognized building codes, such as BOCA—Building Officials and Code Administrators International, Inc., and ICBO—International Conference of Building Code Officials as well as others. There are state and local building codes that also provide the same service and interest assuring a safe and consistently built living or working space. There are specific building codes that are designed to prevent excessive moisture from damaging the building materials. There are also maintenance practices that are required to prevent excessive moisture from damaging the building materials.
- b. Water drainage from adjoining properties, changes to your home site or incorrect building procedures or damage can allow excessive water or moisture to penetrate basement walls, flow beneath concrete slabs and basement floors and into crawl spaces. High water tables can necessitate the use of sump pumps to pump water that is flowing beneath a concrete floor. Pergo flooring should not be installed over any floor with a sump pump or in a room with a floor drain.

**MOISTURE TEST:**

A moisture test is recommended on all concrete subfloors and wood subfloors constructed over a crawl space or basement. Maximum acceptable moisture reading for wood subfloors is 14%. Maximum acceptable moisture reading for concrete subfloors is 4.5% or a moisture vapor emission rate of 5lbs/1000sq. ft/24 hrs. If your moisture readings exceed those listed above, we do not recommend installing Pergo.

**IMPORTANT NOTE:** During a dry season, you may find that you get an acceptable moisture reading even if other job site conditions are not acceptable. Before installing Pergo floors, you must be sure that your job site conditions as well as your moisture readings are acceptable year round.

**JOB SITE CONDITIONS**

Examples of Building Code Requirements and Maintenance Practices that protect homes from excessive moisture exposure

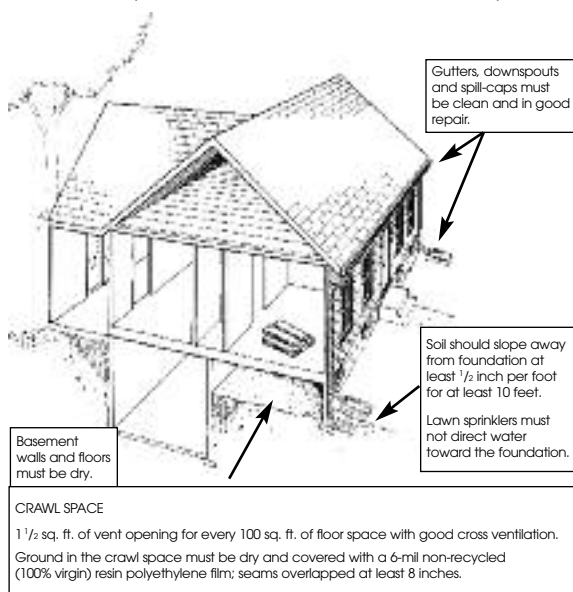

- c. For concrete subfloors, vapor barriers, such as the recommended Pergo 6-mil. polyethylene film installed correctly, 8-inch overlap at seams, installed up to the edge of the wall base or wall, will protect the finished floor from normal water vapor that is emitted through the concrete from a correctly constructed, maintained and undamaged building and correctly graded site that prevents excessive water exposure.
- d. For wood subfloors, a vapor barrier is not placed on the surface of the wood subfloor under any circumstance. When there is a basement, the basement floor and walls must be dry. When there is a crawl space the soil in the crawl space must be covered by a 6 mil (.15mm) non-recycled (100% virgin) resin polyethylene film with seams overlapping at least 8 inches or more. Cover the surface of concrete in crawl spaces with a vapor barrier. Vents should be located throughout the foundation. They must provide good cross ventilation and no dead air space. There must be minimum vent openings equal to 1.5% of the square footage within the crawl space.

Example, 100 square feet of crawl space must have at least 1.5 square feet of open vents. The building must be correctly constructed, maintained and undamaged with a correctly graded site that prevents excessive water exposure.

- e. Grading—Inspect the outside surroundings for improper drainage or obvious sources of moisture. The soil should slope away from the foundation (at least ½ inch per foot for at least 10 feet). Walkways and driveways should direct water away from the foundation. Adjoining properties should drain water away from the building site.
- f. Maintenance—Ensure the eaves are in good repair, gutters, downspouts and spills caps are clear and directing rainwater away from the foundation.
- g. Floor drains or Sump Pumps—do not use Pergo products in any room with a floor drain. Pergo must not be installed over any floor that has a sump pump—i.e. should there be a floor at a below grade level or a on-grade level concrete slab in the home and a sump pump is located in that below-grade level flooring or in the on-grade level slab, then Pergo flooring cannot be installed anywhere on that floor.
- h. Moisture Tests—Moisture tests and job site conditions are inseparable. The results of any moisture reading from meters or other test methods cannot be separated from the above job site conditions. An acceptable moisture reading can be obtained with incorrect job site conditions during a dry season. An acceptable moisture reading must be accompanied with the correct job site conditions to prevent excessive moisture from damaging any finished floor covering.

## 7. SUBFLOOR REQUIREMENTS—GENERAL

- a. The surface of the subfloor must be flat. The flat requirement is defined as follows: the maximum difference between two high points and the intermediate low point is ⅜ of an inch in a 10-foot radius. Surface flatness can also be measured with a 3 foot straight-edge with a flatness requirement of ⅛ of an inch.
- b. Fill excessive voids or low areas using a Portland cement and latex based leveling compound. Allow the leveling compound to dry thoroughly before beginning the Pergo flooring installation. Follow the manufacturer's instructions to be sure it is appropriate for the application. High areas can be sanded, ground down or floated over with an approved self leveling compound.
- c. The subfloor must not slope more than 1 inch in 6 feet.
- d. The surface of the subfloor must be clean.
- e. Use Pergo SilentStep™ or Soundbloc™ Foam or SoftSeal™ Foam/Film combination or equivalents as an underlayment where appropriate.
- f. Any existing wood flooring on concrete subfloors must be removed prior to Pergo installation.

- g. Carpet, pad and tack strips must always be removed.
- h. If there is any question about the suitability of the subfloor or its moisture content, contact the Pergo Technical Support Service at 1-800-33-PERGO (1-800-337-3746).

## 8. WOOD SUBFLOOR REQUIREMENTS

\*These average moisture content measurements for interior wood are based on a well-ventilated building without excessive moisture. Department of Agriculture—Forest Products Laboratory. Wood handbook—Wood as an Engineering Material.

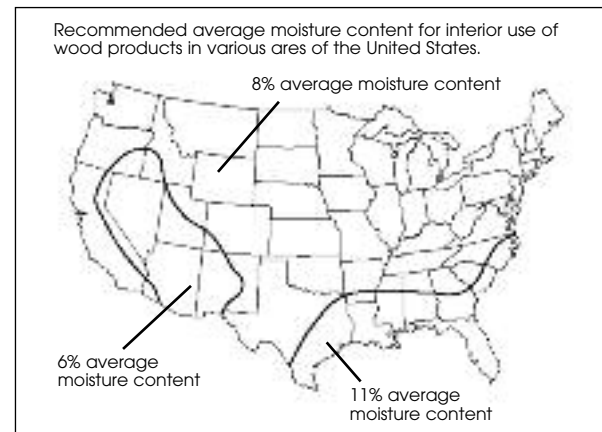

When installing Pergo flooring the maximum acceptable moisture reading for wood subfloors is 14%.

- a. Wood based products, once acclimated to the interior of the home, have a stabilized moisture content\* relative to the geographic area where they are being installed.
  - Most areas in the United States will average 8% moisture content—Range 6 to 10%.
  - Dry southwestern areas will average 6% moisture content—Range 4 to 9%.  
New Mexico, Arizona, Nevada and areas in Colorado, Wyoming and Idaho and eastern California.
  - Damp, warm coastal areas will average 11% moisture content—Range 8 to 13%.  
Gulf coast and southern Atlantic coast, Texas, Louisiana, Mississippi, Alabama, Florida, Georgia, and the Carolinas.
  - Homes that are closed without adequate ventilation during hot and humid seasons will exhibit "Closed House Syndrome" where the interior humidity level rises above 90%, increasing the moisture content of the wood products within the home. This condition can cause excessive expansion of any wood based flooring including Pergo flooring. Ventilation of these homes is highly recommended. Consult your building contractor for recommendations.

- b. Plywood or other wood materials for subflooring should meet the building code requirements.
  - Creaking subfloors must be repaired before installation of the finished floor covering.
  - If the subfloor sags, inspect the joists below for twists or weakness.
    1. If the subfloor is cupped or is uneven at the joints take moisture readings and inspect for sources that may be allowing excessive moisture into the building.
    2. Check for excessive moisture in the crawl space or basement and look for other signs of a potential water problem. (See Job Site Evaluation, section 6.)
- c. High areas, such as peaked joints in the subfloor or other ridges in the wood subfloor must be sanded or planed and low areas repaired or filled with a Portland cement and latex based leveling compound or covered with a rigid underlayment. When using a leveling compound, be sure to follow the manufacturer's recommendations, and allow the compound to dry completely before starting to install the Pergo Flooring. See Subfloor Requirements/General, section 7, paragraph a.
- d. Pergo Moisturbloc™ and Pergo SoftSeal™ or a polyethylene film must not be used on the top of a wooden floor or wood subfloor. These products are only used on concrete subfloors.
- e. When the subfloor is wooden, Pergo laminate flooring can be installed over parquet, planks or other wood flooring or wood based flooring installed on the wood subfloor.
- f. If you have questions or doubts about how to proceed in your situation, call us at 1-800-33-PERGO (1-800-337-3746).

IMPORTANT NOTE: During a dry season, you may find that you get an acceptable moisture reading even if other job site conditions are **not** acceptable. Before installing Pergo floors, you must be sure that your job site conditions as well as your moisture readings are acceptable.

- g. Should excessive moisture be present or if the job site conditions are not correct consult a waterproofing or flooring contractor for further moisture testing or abatement before installing a Pergo floor.

## 9. CONCRETE AND TERRAZZO SUBFLOOR REQUIREMENTS

—When installing Pergo flooring, the maximum acceptable moisture reading for concrete subfloors is 4.5% or a moisture vapor emission rate of 5lbs/1000sq. ft./24 hrs.

- a. Concrete and terrazzo release moisture long after it is poured and can transfer dampness from wet soil and the air, i.e., elevated concrete floors in apartment and office buildings. New concrete must cure for 60 days before any flooring is installed.
- b. Check the floor for flatness. If the concrete or terrazzo subfloor has excessive voids or variations, a leveling compound can be used to bring it up to specifications. (See Subfloor Requirements/General.) Low areas

greater than 3/8" in a 10' radius should be filled in using a Portland cement and latex-based floor leveler. Follow the manufacturer's directions for mixing the filler, and be sure to allow it to dry completely. High spots or ridges above 3/8" within a 10' radius (or 1/8" of an inch within a 3 foot radius) must be ground down.

- c. When installing Pergo flooring over a concrete or terrazzo subfloor you must use a 6-mil. (.15mm) non-recycled (100% virgin) resin polyethylene film such as Pergo Moisturbloc™ or Pergo SoftSeal™ combination foam/film to form a vapor barrier. When the Pergo Product has an attached underlayment foam, use only a vapor barrier with this product when installing over a concrete subfloor. The edges of the vapor barrier must overlap by at least 8 inches (200mm) or when using an equivalent, non-recycled, polyethylene film, follow the manufacturer's direction for installation. Vapor barrier underlayments are required over all subfloors containing concrete, even if the concrete is covered by vinyl, linoleum VCT (resilient tile), terrazzo or ceramic tile.
- d. Evaluation of moisture conditions for concrete or terrazzo subfloors. (Also see Job Site Evaluation—exterior and interior moisture conditions—section 6.) If there is excessive moisture in the concrete or the job site conditions are not correct then Pergo flooring cannot be installed.
- e. When a resilient tile is installed over concrete subfloors and there is visible salt deposits at any of the joints of the tile there is reason to believe that excessive moisture is present.
- f. A precise moisture reading can be obtained using the Calcium Chloride Test. Three tests must be used for the first 1000 sq. ft. and one additional test for each 1000 sq. ft. or fraction thereof (ASTM 1869-03). The results of the tests must not exceed 5lbs/1000 sq.ft/24 hrs (not to exceed five pounds of water vapor being emitted from 1000 square feet of flooring over a period of 24 hours).
- g. Moisture meters, correctly calibrated, and used can also provide moisture readings. See the meter manufacturer's instructions for use and interpretation of the meter readings.
- h. Do not install Pergo flooring in a room with a floor drain.
- i. Do not install Pergo flooring over a floor with a sump pump. Pergo flooring must not be installed over any floor that has a sump pump, i.e. should there be a floor at a below grade or an on-grade level concrete slab in the home and a sump pump is located in that below-grade level flooring or in the on-grade level slab, then Pergo flooring cannot be installed anywhere on that floor.

IMPORTANT NOTE: During a dry season, you may find that you get an acceptable moisture reading even if other job site conditions are not acceptable. Before installing Pergo floors, you must be sure that your job site conditions as well as your moisture readings are acceptable.

- j. Should excessive moisture be present or the job site conditions are not correct, consult a waterproofing or flooring contractor for further moisture testing or abatement before installing a Pergo floor.

## 10. OTHER SUBFLOOR REQUIREMENTS

- a. Vinyl sheet goods, linoleum and resilient (VCT) tiles: Old vinyl and linoleum tiles or sheet goods normally do not need to be removed. Some older vinyl sheet goods and tile contain asbestos. Should you choose to remove these older floor coverings, consult a floor covering retailer or the manufacturer of the vinyl floor covering regarding the contents. Should it contain asbestos special precautions for your safety must be taken.
- b. When Pergo flooring is installed over vinyl, linoleum sheet goods, over resilient tiles or ceramic tiles and the subfloor is concrete, a vapor barrier is always required.
- c. Ceramic tiles and terrazzo: Old ceramic tiles normally don't need to be removed. Usually, Pergo flooring can be installed directly over ceramic tiles and terrazzo providing they are smooth, sound and dry. These flooring materials must be smooth and flat to within  $\frac{3}{16}$ " in a 10' radius. (See Subfloor Requirements/General, section 7.)
- d. Use Pergo Moisturbloc™ together with Pergo SilentStep™ or Pergo Soundbloc Foam™ or use the 2 in 1 product, Pergo SoftSeal™ Foam/Film combination, or equivalent if the subfloor is concrete.
  - If the Pergo Product being installed has an attached foam underlayment then use only a vapor barrier when installing over a concrete subfloor.
  - When installing a Pergo Product with an attached underlayment foam over a wood subfloor no other additional acoustic underlayment should be used.

**11. NEW CONSTRUCTION REQUIREMENTS**—There are several special considerations that must be evaluated before installing Pergo flooring in new construction.

- a. As with all wood-based flooring products, the installation should be scheduled as late in the building cycle process as possible. This will prevent any unnecessary damage from occurring as the result of other trades involved with the construction process. Always protect the floor if other trades will be walking on the floor after installation.
- b. The house/building must be closed and the climate controls should be in operation for at least two weeks. The temperature should be maintained between 65°F and 85°F during these two weeks and the relative humidity should average between 30% and 90%.
- c. Close attention must be paid to the condition of the subfloor. (See sections 7 through 10 for your specific subfloor requirements.)
- d. Moisture in the wood or concrete subfloor, foundation walls, basement, or crawl space must be checked and verified to be in compliance with the subfloor requirements. (See Job Site Evaluation, section 6— exterior/interior moisture conditions and sections 7 through 10 for your specific subfloor requirements.)
- e. Kitchen cabinets should be installed before the floor is installed. However, cabinets may be installed after

the floor is in place providing the cabinets, island cabinets, etc. are not fixed/attached to the Pergo floor. Island cabinets can be anchored to the subfloor. The holes for the anchoring bolts or screws must be  $\frac{3}{4}$ " on center, larger than the diameter of the bolts or screws—this allows for the  $\frac{1}{4}$ " expansion space needed for a floating floor to move without being obstructed by the fastener. Other cabinets must be fastened to walls or to the subfloor as described for island cabinets.

- f. Specific areas of the expansion spaces, and only specific areas where there is water exposure, such as the expansion space in front of the kitchen sink, in front of the dishwasher or around the dishwasher space if the dishwasher has not been installed yet, in the refrigerator space and around any water supply line, in front of any exterior doors and sliding glass doors must be filled with Pergo Sealant or a 100% mildew-resistant silicone sealant that will remain flexible. (Also see sections 12 through 14, for Kitchen, Bathroom and Laundry Room Installations.)

**12. BATHROOM INSTALLATIONS**—Because the Pergo surface is resistant to water, Pergo laminate flooring can be installed in bathrooms. However, it is very important to prevent water or moisture from getting under the floor.

Installation in bathrooms must be made in accordance with the following instructions:

- a. The expansion spaces, all expansion spaces, between the Pergo flooring and walls, the doorway transition or other fixed objects such as pipes for radiators, sinks, water supply to water closet or toilet flanges **MUST** be sealed with Pergo Sealant or 100% mildew-resistant silicone.
- b. The space around the perimeter of the Pergo floor must be  $\frac{3}{8}$ " wide and sealed prior to installing the wall trim. The  $\frac{3}{8}$ " expansion space must be completely filled with sealant to avoid water getting underneath the floor.
- c. When Pergo flooring is installed in a bathroom and an adjoining hall or room, a T-Molding must be installed in the doorway between the rooms or hallway and the expansion space under the T-Molding must be filled with the proper sealant. Place sealant in the expansion space of any flooring transition in the doorway of a bathroom.
- d. Pergo must not be installed in rooms with a floor drain.
- e. Pergo must not be installed over any floor that has a sump pump—i.e. should there be a bathroom at a below grade level or on-grade concrete slab in the home and a sump pump is located on that below-grade level flooring or on the on-grade level subfloor, then Pergo flooring cannot be installed anywhere on that floor.
- f. Standing liquids should not remain on the surface of a Pergo floor. Standing water is defined as water that has set on the surface of the flooring for longer than 30 minutes.

**13. KITCHEN INSTALLATION**—It is recommended that kitchen cabinets be installed prior to installing Pergo flooring. Install the planks up to the kick plate of the cabinet, leaving a  $\frac{3}{8}$ " expansion space. Cover the expansion space with a quarter round molding.

Installation in kitchens must be made in accordance with the following instructions.:

Place Sealant only in the specific expansion spaces listed.

- a. Cabinet with kitchen sink: The  $\frac{3}{8}$ " expansion space in front of the cabinets that house the dishwasher and kitchen sink MUST be filled with Pergo Sealant or 100% mildew-resistant silicone.
- b. Dishwashers: When installing Pergo flooring in the dishwasher space beneath cabinets, sealant MUST be used in the perimeter expansion spaces where the dishwasher is sitting. When flooring abuts the dishwasher, place a full bead of sealant beginning at the top edge of the floor down to the subfloor in front of the dishwasher.
- c. Refrigerators: When installing Pergo flooring in the refrigerator space, sealant MUST be used in the perimeter expansion spaces where the refrigerator is sitting. Be sure to place sealant around openings for water supply lines to the icemaker of the refrigerator.

NOTE: For built-in refrigerators, follow instructions for sealing as for dishwashers.

- d. Exterior doors: The expansion space in front of any exterior door MUST be filled with sealant.
- e. Use Pergo SilentStep™ or Pergo Soundbloc™ or an equivalent as the foam underlayment for Pergo products without an attached underlayment. Use the Pergo Moisturbloc™ or equivalent 6-mil. (.15mm) non-recycled (100% virgin) resin polyethylene film as a vapor barrier when installing over a concrete subfloor.
- f. Pergo must not be installed in rooms with a floor drain.
- g. Pergo must not be installed over any floor that has a sump pump—i.e. should there be a kitchen at a below grade level or on-grade concrete slab in the home and a sump pump is located in that below-grade level subfloor or in the on-grade level subfloor, then Pergo flooring cannot be installed anywhere on that floor.

All reference to sealant means Pergo sealant or a 100% mildew-resistant silicone sealant.

**14. LAUNDRY ROOM INSTALLATIONS**—All expansion spaces in a laundry room MUST be filled with sealant.

- a. Pergo must not be installed in rooms with a floor drain.
- b. Pergo must not be installed over any floor that has a sump pump—i.e. should there be a laundry room at a below grade level or on-grade concrete slab in the home and a sump pump is located in that below-grade level subfloor or in the on-grade level subfloor, then Pergo flooring cannot be installed anywhere on that floor.
- c. The expansion space around the perimeter of the Pergo floor must be  $\frac{3}{8}$ " wide and sealed prior to

installing the wall trim. The  $\frac{3}{8}$ " expansion space must be completely filled with sealant to avoid water getting underneath the floor.

- d. The expansion space in front of any exterior door MUST be filled with sealant.
- e. Use Pergo SilentStep™ or Pergo Soundbloc™ or an equivalent as the foam underlayment for Pergo products without an attached underlayment. Use the Pergo Moisturbloc™ or equivalent 6-mil. (.15mm) non-recycled (100% virgin) resin polyethylene film as a vapor barrier when installing over a concrete subfloor.
- f. When Pergo flooring is installed in a laundry room and an adjoining hall or room, a T-Molding must be installed in the doorway between the rooms or hallway and the expansion space under the T-Molding must be filled with the proper sealant. Place sealant in the expansion space of any flooring transition in the doorway of a laundry room.

**15. RADIANT FLOOR HEATING**—Pergo flooring can be used in combination with many types of in-floor heating. The heating system can be cast in a concrete floor or in a thin layer of filler on the surface of a concrete subfloor. It can also be installed under a wood sub floor or installed on the surface of the subfloor as an electrical matting as long as it meets the floor flatness requirements.

- a. Follow the instructions from the supplier of the floor heating system.
- b. Concrete subfloors must be installed and cured with no heat transfer for a minimum of 60 days.
- c. The heating system must be in operation for at least two weeks before installation. The system may be turned off or set to a suitable installation temperature (65 to 72°F).
- d. The flooring surface temperature, that is the surface of the subfloor or the heat radiating from electric heating mats, should not exceed 84°F (29°C).

**16. COTTAGES AND ROOMS WITHOUT CLIMATE CONTROL**—Pergo can be installed in homes or rooms without climate control with the following conditions:

- a. Pergo installation essentials must be met.
- b. The crawl spaces must be enclosed and vented and meet all requirements, and the job site conditions must be correct.
- c. Insulation of the floor in the crawl space is recommended.
- d. The floor must not be installed in an area where it will be exposed to constant dampness or extremely high or low humidity. Relative humidity must range between 30-90%. The temperature should be at least 65°F for the product acclimation and at least 65°F two days after the installation.
- e. Cottages or homes that are closed without adequate ventilation during hot and humid seasons will exhibit "closed house syndrome" where the interior humidity level rises above 90%. Ventilation of these cottages or homes is highly recommended. Consult your building contractor for recommendations.

**17. COMMERCIAL APPLICATIONS**—(Only for those products that are designated for commercial use by Pergo, Inc.)

In commercial applications, an expansion space of 1/2" is required at all walls, pillars, pipes and other fixed objects.

Areas greater than 40 feet in length or width, and consecutive multiples of 40 feet, i.e. (one room; two or more rooms with adjoining archways greater than 4 feet; large room with extended hallway) must have a T-Molding installed across the width of the room, archway or at the beginning of the hallway to provide additional expansion space.

When fastening fixtures to a floating floor, the anchoring bolts or fasteners must have the same expansion space (1/2 inch) around each bolt or fastener as required for walls, pillars, pipes and other fixed objects.

Commercial flooring transitions that accommodate a 1/2" expansion space are strongly recommended.

**18. INSTALLING PERGO FLOORING ON STEP DOWN AND STAIR TREAD APPLICATIONS**—Pergo Stair Nosing is used to finish stair edges or step down applications. Prior to beginning the installation, any loose or damaged treads or risers should be repaired or replaced. The stairs must be cleaned thoroughly from any loose paint, debris, or old adhesives.

Due to the many varieties of stairs available in North America, a professional stair contractor may be required for certain installations. Check local building codes before altering dimensions of stair tread, riser and nosing.

Should there be any questions regarding the application of Pergo on stairs, please call our Customer Help line at 1-800 33-PERGO (1-800-337-3746).

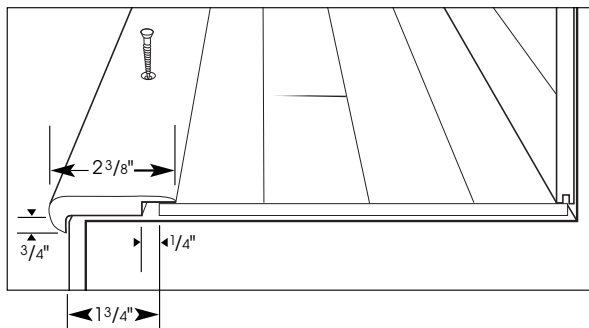

**STAIR NOSING**

- **Step down from a floating floor**  
Cut the Pergo stair nosing to the desired length. The nosing must be fastened with screws (ie. finishing screw #6 by at least 1 1/8"). A quality construction adhesive should also be used. A 1/4" expansion space must be maintained between the nosing and the floating floor. For Step Down (from a floating floor) to a lower level or at the top of a flight of stairs: Adhere the stair nosing with a quality construction adhesive and with #6 finishing screws 1 1/8" in length. Place screws 2 inches from each end of the nosing and space additional screws at intervals no greater than 8 inches along the length of the nosing.

- a. For 5/16" (8mm) plank thickness use the thin shim beneath the stair nosing. Adhere the shim to the nosing with construction adhesive and adhere the shim and nosing to the subfloor with construction adhesive and fasten with screws
- b. For 3/8" (9-11mm) plank thickness use the thick shim beneath the stair nosing. Adhere the shim to the nosing with construction adhesive and adhere the shim and nosing to the subfloor with construction adhesive and fasten with screws

**Stair Treads only:** Adhere the stair nosing with a quality construction adhesive and fasten with #6 finishing screw 1 1/8" in length. Place screws 2 inches from each end of the nosing and space additional screws at intervals no greater than 8 inches along the length of the nosing.

- For 5/16" (8mm) plank thickness do not place any shim beneath the stair nosing. Adhere the stair nosing directly to the tread with construction adhesive and fasten with screws
- For 3/8" (9-11mm) plank thickness use the thin shim beneath the stair nosing. Adhere the shim to the nosing with construction adhesive and adhere the shim and nosing to the tread with construction adhesive and fasten with screws
- For 5/16" (8mm) plank thickness with an attached underlayment foam use the thin shim beneath the stair nosing. Adhere the shim to the nosing with construction adhesive and adhere the shim and nosing to the tread with construction adhesive and fasten with screws

This illustration shows the step down from a floating floor. The step down shows the tread flush or even with the riser.

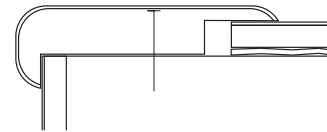

- **Tread flush or even with the riser**  
The riser must be installed before the stair nosing is fit into place. If installing from a floating floor, follow the above instructions. When installing on a stair tread, the nosing will be installed after the tread and riser are glued into place.

- **Tread with an extended round edge nosing**  
The rounded portion of the extended nosing will need to be squared. Leave as much of the extending nose of the tread as possible, removing only the radius (the rounded portion). On the edge of the squared nosing, glue a narrow strip of Pergo. This will finish the exposed edge of the tread. After installing the tread and riser the nosing will be installed, finishing the nose of the tread. The illustration shows a step with an extended round edge nosing. On the illustration a dotted line will show where to cut the rounded portion of the extended nosing.

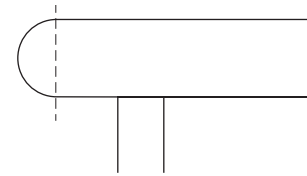

- **Tread with extended and square edge nosing**  
On this style of tread simply cut a narrow strip of Pergo and glue it on the edge of the existing tread. Install the tread and riser and finish the edge with a



Pergo nosing. The illustration at right shows a square edge nosing with Pergo on the edge, and installed Pergo on the tread and riser with a Pergo nosing finishing the nose of the tread.

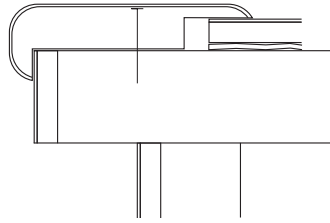

#### PERGO ON STAIR TREADS AND RISERS

1. Dry fit the Pergo planks net, or snug, stringer to stringer (from left to right side). Remember that the depth of Pergo tread material will be cut to accommodate the width of the Pergo nosing which overlaps either a riser of Pergo or the piece of Pergo which is glued on the edge of the step.
  - a. One plank of Pergo will finish most risers; however, two planks of Pergo will be needed for the tread since tread depth exceeds the width of one Pergo plank.
  - b. Personal preference will determine your choice to install the riser or the tread first. In either event, the joint between the tread and riser should be sealed with Pergo sealant. Pergo quarter round can also be used.
2. After dry fitting, the Pergo planks must be adhered to the stair treads in one of the following ways:
  - a. Fully spread a premium quality parquet adhesive on the tread and riser. This should be performed in accordance with the manufacturer's speci-

fications. Make sure to press the Pergo into the adhesive to get proper bonding. Allow the recommended amount of time for the adhesive to fully set up before using the stairs.

OR

- b. Apply several continuous beads of a premium quality construction adhesive across the full width of the tread and riser. This should be performed in accordance with the adhesive manufacturer's specifications. Firmly press the Pergo into the adhesive to ensure proper bonding. Allow the recommended amount of time for the adhesive to fully set up before using the stairs.

**NOTE:** On wood or concrete surfaces, stair nosing must be fastened with construction adhesive and screws to the treads. A stair application is the ONLY time that a Pergo floor is glued directly to a substrate. Pergo is installed as a floating floor for a step down and all other applications.

- **Mechanical Fasteners for Stair Nosing Over Wood Subfloors:** Use a premium grade of construction adhesive and trim screws at least 1 1/8" in length. Drill holes in the molding for the fasteners. Countersink the screws and fill with Pergo Finishing Putty. When fastening the stair nosing, space screws 2 inches from each baseboard or stringer and a maximum distance of 8 inches apart down the length of the nosing.
- **Concrete Subfloors:** Drill into the concrete subfloor with a carbide drill bit. Insert an appropriate plug into the concrete to accommodate the fastener then follow the procedure above.

