

# OWNER'S MANUAL

How to employ your intelligent floor cleaner

bObsweep Standard  
Model No. WB4727546



## Congratulations!

Congratulations on your new intelligent floor cleaner! Bob is now at your service. To see Bob at his best, please read the Quick Start Guide and this manual thoroughly. Welcome to the bObsweep family and happy cleaning!

If you have any questions or concerns, feel free to contact our helpful team at: [support@bobsweep.com](mailto:support@bobsweep.com).

6

Important Safety  
Instructions

8

What Comes in  
Bob's Box?

10

Bob's Anatomy

14

Getting Bob  
Ready to Clean

Install Bob's  
Side Brush 16  
Charge Bob 17  
Bob's First Clean 19  
Standby Mode 20

22

Remote Control

26

Charging Bob

Charging Station  
Placement 28  
Auto Charging 29  
Manual Charging 30  
Charging Time 31  
Conserving Battery 32

34

Cleaning  
Modes

Auto 1: Robot Mode 37  
Auto 2: Quick Clean 38  
Auto 3: Touch up 39  
Small-area Cleaning 40  
UV Light 41

44

Set Bob's  
Cleaning Schedule

Use Bob's  
Charging Station 44  
Set Current Time & Day 45  
Set Bob's  
Cleaning Schedule 48  
Back-to-back Cleaning 51

52

Parts &  
Maintenance

Mop 54  
Dustbin 56  
Filters 58  
Brushes 60  
Battery 64  
Storing Bob 65

66

## Sensors

Maintenance 68  
Blindfold Stickers 69

70

## Troubleshooting

Error Codes 72  
Home Checkup  
Test 78

86

## Warranty Information

89

## Cleaning Behavior

90

## Bob's Challenges

92

## FAQs

98

## End User Agreement

## Important Safety Instructions

Basic safety precautions should always be followed, including the following:

Read ALL instructions before use.

To protect against electrical shock, do not immerse any part of Bob — with the exception of his mopping cloth — into water or other liquids.

Unplug Bob from outlet when not in use and before conducting maintenance.

Do not operate Bob or his charging station if they have been damaged in any way. If Bob is not working as he should, or has been dropped, damaged, left outdoors, or dropped in water, contact our customer care center at [support@bobsweep.com](mailto:support@bobsweep.com).

Do not handle Bob or his charging station with wet hands; use only on dry surfaces.

Do not use Bob outdoors.

Bob is not intended for use by persons (including children) with reduced physical or mental capabilities, or lack of experience and knowledge, unless under the close supervision of a person responsible for their safety.

Do not pull or carry the charging station by the cord, use the cord as a handle, close a door on the cord, or pull the cord around sharp edges or corners. Keep the cord away from heated surfaces. To unplug the cord, grasp the plug, not the cord itself.

Do not mutilate or incinerate the battery, as it will explode at high temperatures.

Do not attempt to open Bob's charging station. Repairs on his station should only be carried out by our qualified customer care center.

Do not expose Bob's charging station to high temperatures or allow moisture or humidity of any kind to come into contact with it.

Do not let Bob pick up toxic materials (chlorine bleach, ammonia, drain cleaner, etc.).

Do not let Bob pick up anything that is burning or smoking, such as cigarettes, matches, or hot ashes. Do not use Bob to pick up flammable or combustible liquids such as gasoline, nor use him in areas where they may be present.

Do not use Bob in an enclosed space filled with vapors given off by oil-based paint, paint thinner, moth-proofing substances, flammable dust, or other explosive or toxic vapors.

Leaks from battery cells can occur under extreme usage or temperature conditions. If the liquid gets on skin, wash quickly with water. If the liquid gets into the eyes, flush them immediately with clean water for a minimum of 10 minutes, and seek medical attention.

Do not use Bob for anything other than his intended purpose, as specified in this manual.

## What Comes in Bob's Box?

Bob, Your Intelligent Floor Cleaner **1**

Charging Station **2**

Blö Main Brush **3**

Charging Adapter **4**

Remote Control **5**

Phillips head screwdriver **6**

2 Side Brushes (1 Spare) **7**

Cleaning Tool **8**

Pack of Screws & Blindfold Stickers **9**

Mop Attachment **10**

2 Micro-Fiber Mopping Cloths **11**

Filter Replacement **12**

Owner's Manual, Quick Start Guide & Warranty Card **13**

Bumper Stickers **14**

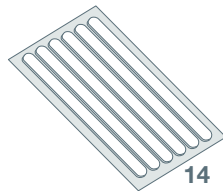
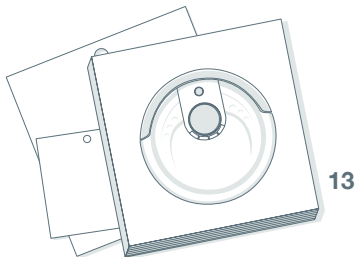
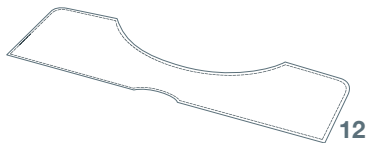
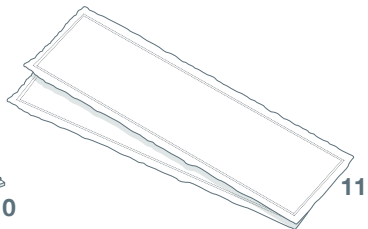
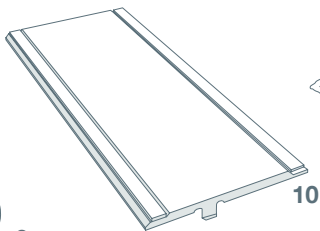
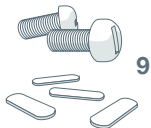
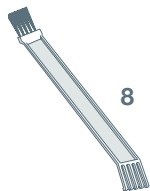
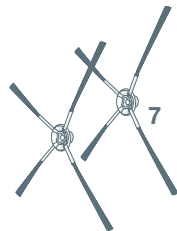
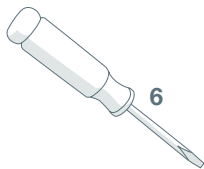
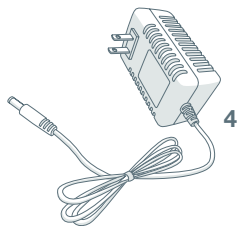
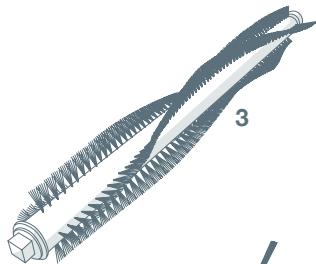
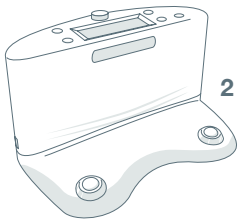
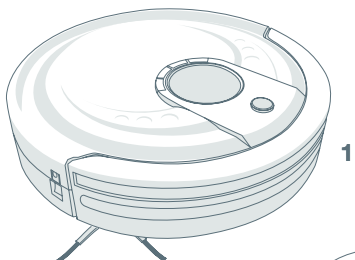



## Bob's Anatomy

### Top View

Bumper 1

Signal Transmitter 2

Cover Buttons 3

Display 4

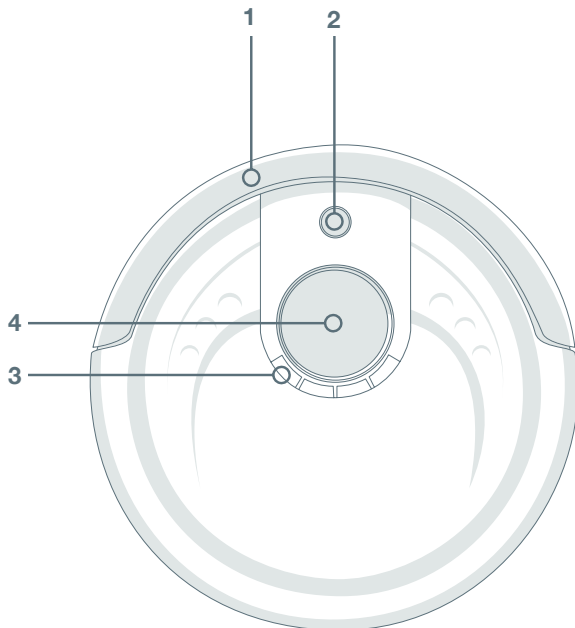

## Bottom View

Charging Plates 1

Front Wheel 2

Side Brush 3

Main Brush 4

ON/OFF Switch 5

Dustbin 6

UV Lamp 7

Battery 8

Left and Right Wheels 9

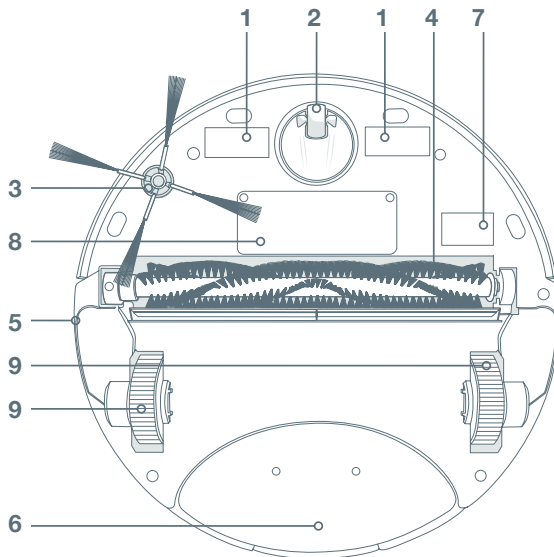

Remote 1

Charging Station 2

Display Screen 3

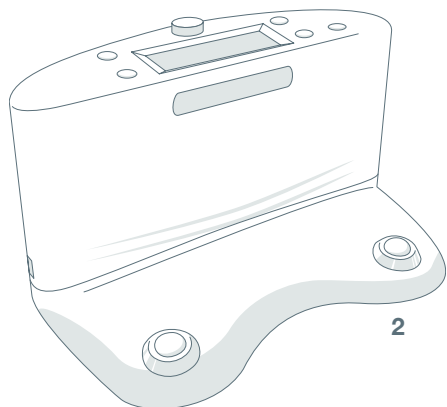

2

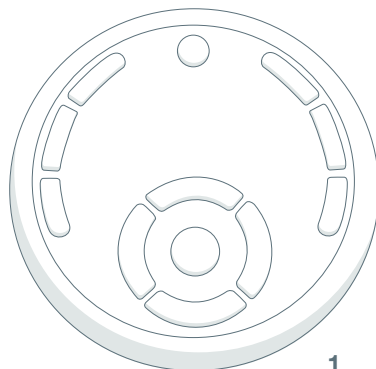



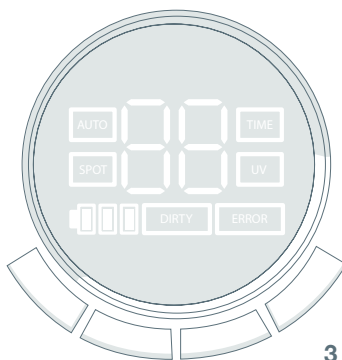

1



3

## Cover Buttons

-  **1**  
Select Bob's cleaning mode
-  **2**  
Select Bob's cleaning program
-  **3**  
Turn UV lamp OFF/ON
-  **4**  
Bob will start cleaning on his default setting

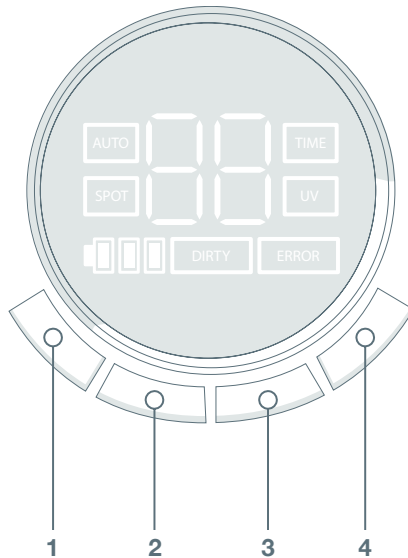

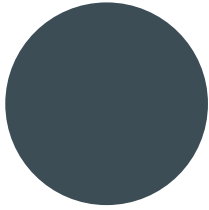
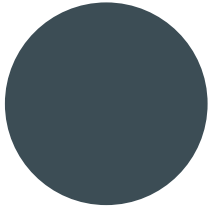
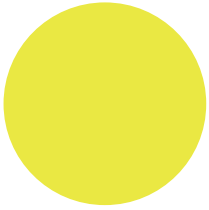
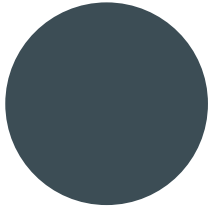
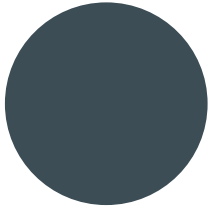
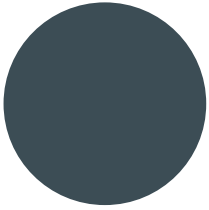
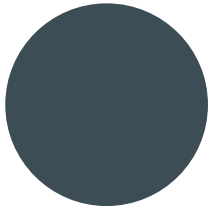
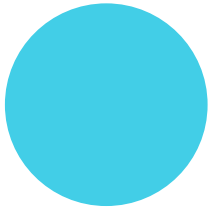
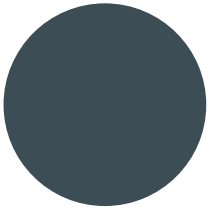

# Getting Bob Ready to Clean

## Install Bob's Side Brush

Before Bob's first clean, you must install his side brush, which allows him to sweep along corners, walls, and other hard-to-reach places.

To do this, you will need the following materials, all of which are included inside Bob's box: a side brush, a Phillips head screwdriver, and a short screw.

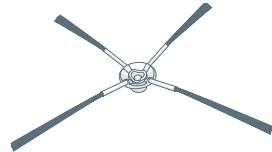
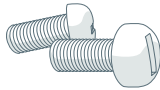

1

Flip Bob over onto a flat surface. Place the side brush over the empty socket on Bob's underside.

2

Secure Bob's side brush onto the socket using the Phillips head screwdriver and short screw.

3

You may use the additional side brush and screws as spares.

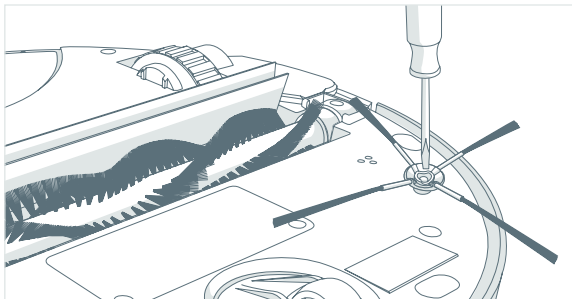

## Charge Bob

After installing Bob's side brush, you must set him to charge.

To charge Bob:

1

Turn Bob's power switch ON. Bob's screen will light up. Plug the charging adapter into the side of the charging station. The station's screen will turn on.

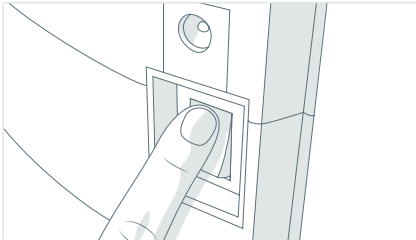

2

Place Bob on his charging station with the metal plates on his underbelly sitting on top of the nodes on his station.

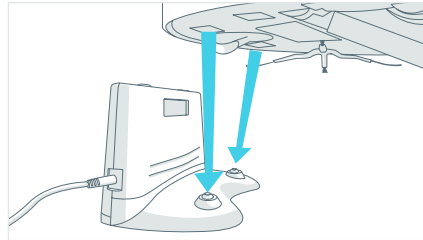



The charging station's memory can store the cleaning schedule and current time for at least 8 hours without electricity. This will give you plenty of time to re-plug the adapter back into the charging station after Bob comes to life.

## Bob's First Clean

Bob is now ready to clean! Press the ▶|| button on his cover twice — or the AUTO button on his remote once — and he will clean on his default auto1 setting (Robot mode).

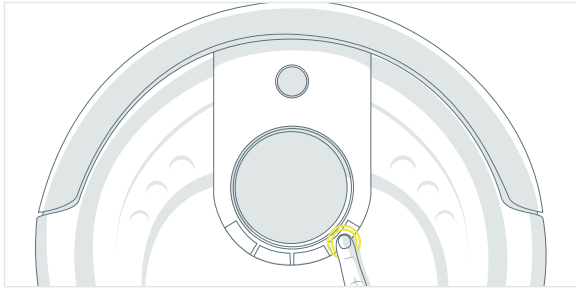

OR

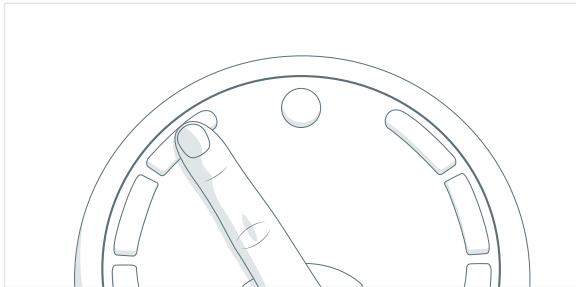

## Standby Mode

If Bob is left idle for more than a minute, he enters Standby Mode to preserve battery. In this mode, Bob's screen will turn off and he will sit quietly, awaiting your command to either resume cleaning or go to charge.

To get Bob back to cleaning:



OR



Press ▶|| on Bob's cover twice.

Press the ON/OFF button on Bob's remote to wake him up, then press AUTO on the remote to send him back to work.

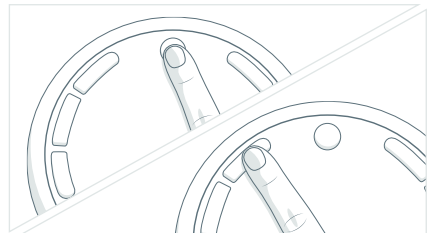
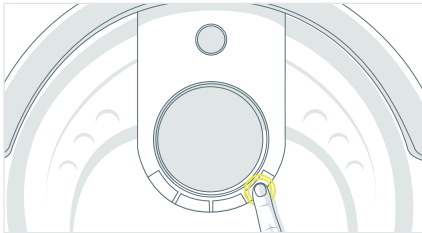

To send Bob to his charging station:

1

Press the ON/OFF button on Bob's remote to wake him up.

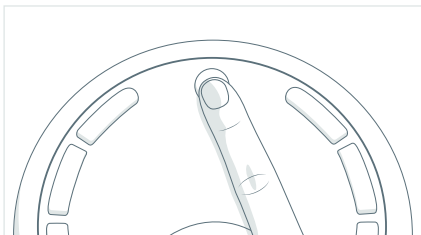

2

Then press CHARGE.

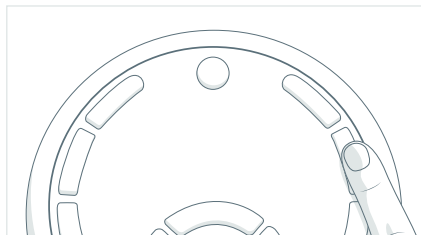

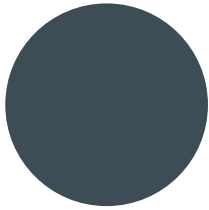
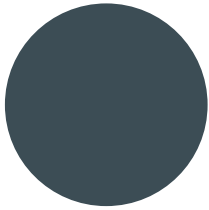
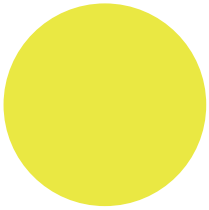
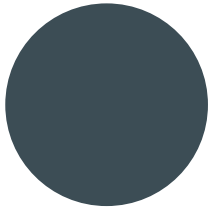
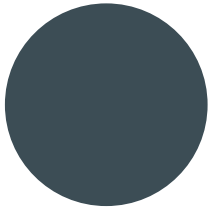
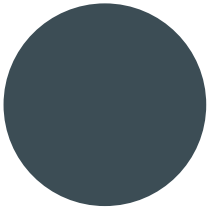
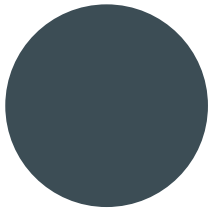
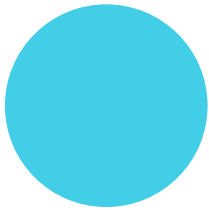
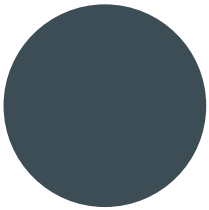

# Remote Control

## Remote Control

In order to change Bob's movements, you may select his cleaning speed and patterns using his remote control.

Bob's remote control works at an average distance of 10 feet. It must be pointed directly at Bob with no obstacle blocking its signal.

Bob's remote has the following buttons:

Power 1

Auto 2

Corners 3

UV 4

Spot 5

Charge 6

Speed 7

Navigational Arrows 8

Pause 9

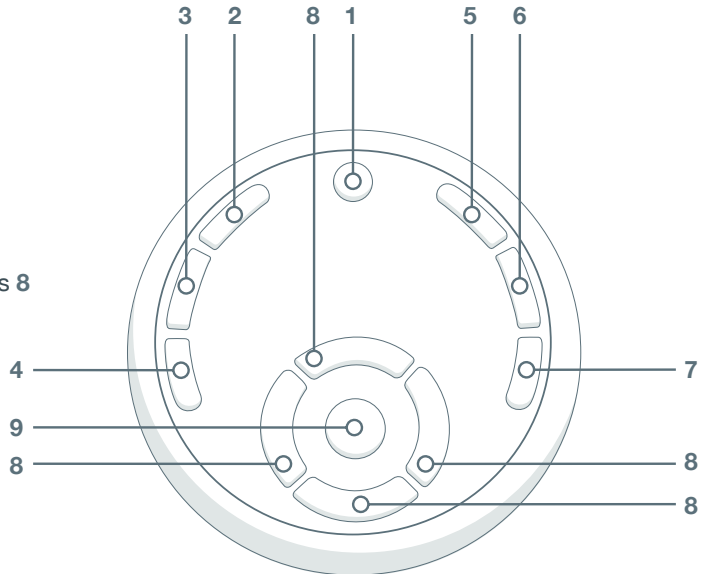

### Power

- Wakes Bob or puts him in standby mode

### Auto

- Bob will start cleaning on his default mode (Robot)

### Corners

- Bob will start cleaning corners and alongside walls

### UV

- Turns the UV light on and off while Bob is cleaning

### Spot

- Activates Bob's Spiral Track™

### Charge

- Sends Bob to his charging station

### Speed

- Sets Bob's speed to slow or default

### Navigational buttons

- Guides Bob forward, backward, right, or left

### Pause

- Pauses or resumes Bob's movements

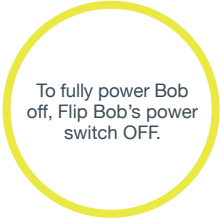

To fully power Bob off, Flip Bob's power switch OFF.



Hold down the navigational buttons to keep Bob moving in the desired direction.

Bob's remote requires 2 AAA batteries (not included). Do not leave the batteries in the remote if you are not using it on a regular basis. Keep the remote at a normal room temperature.



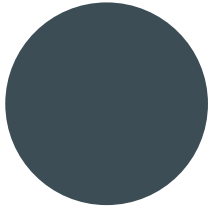
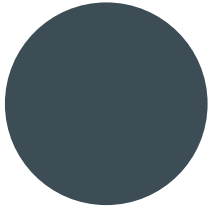
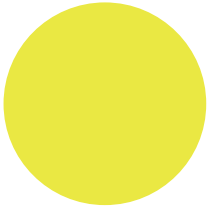
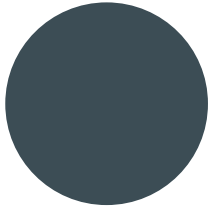
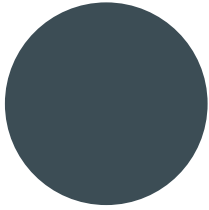
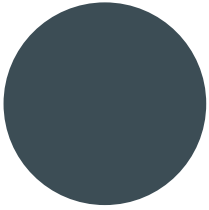
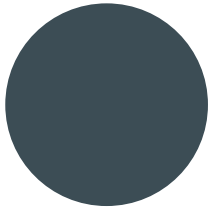
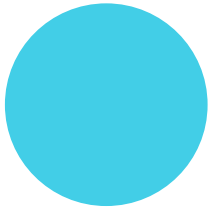
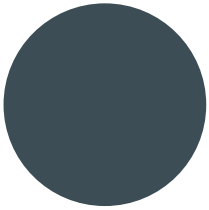

# Charging Bob

## Charging Station Placement

- Position the charging station against a wall on a hard, flat surface.
- Make sure there is at least 10 feet (3 meters) of open space to the front and 2 feet (0.5 meters) to the sides.
- Plug the charging adapter into the side of the charging station. The station's screen will turn on.

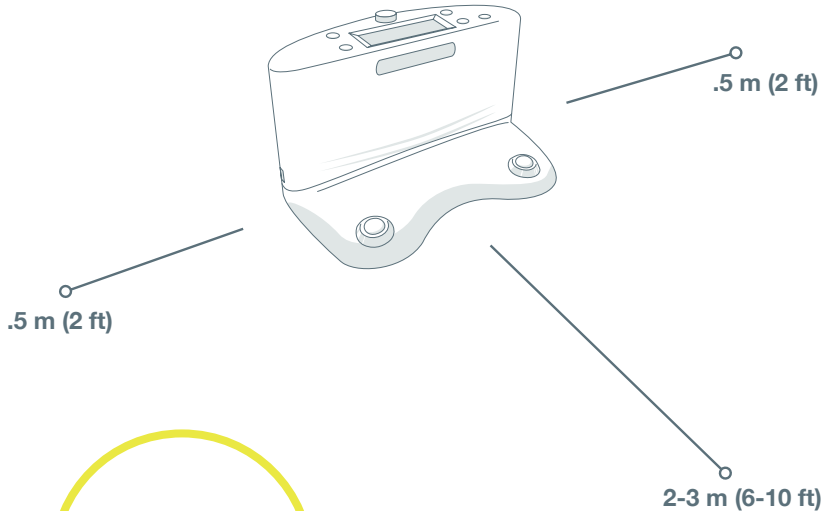

The transmitter on Bob's station should be clean and free of dust.

## Auto Charging

To send Bob to charge:

Bob is smart and will automatically search for his charging station when his battery falls below 15%. You may also direct Bob to his charging station at any time by pressing the CHARGE button on his remote.

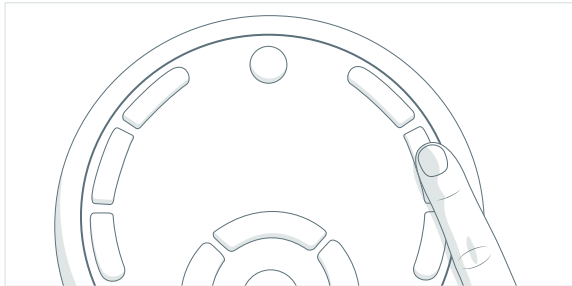

If you press any button while Bob is looking for his charging station, he will stop searching and will enter standby mode. When in standby, Bob chirps every few minutes to inform you of his idle position. Press charge on the remote to send Bob to his charging station or place him on his station (see Manual Charging).

## Manual Charging

Plug the power adapter directly into the inlet on Bob's side above his ON/OFF switch, then plug the adapter to the wall.

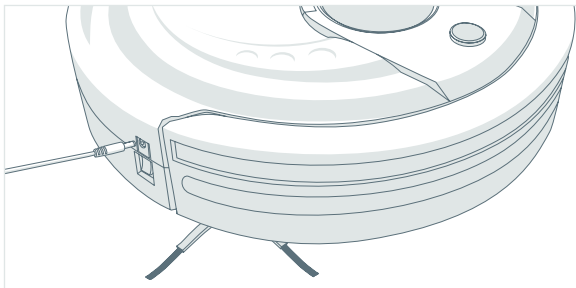

## Charging Time

When Bob is charging, the two-digit number on his display screen indicates how long his battery has been charging. You can calculate the number of minutes Bob has spent charging by multiplying this number by 10. Note that the number starts from 0 every time Bob is put to charge, regardless of how full his battery is. For example, if his screen shows the number 24, that means Bob has been sitting to charge for 240 consecutive minutes (4 hours).

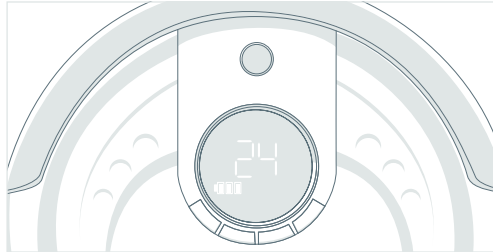

## Conserving Bob's Battery

Bob should not sit on his charging station for more than 5 days with his power switch turned ON. If you will not be using him at least once every 5 days, turn his side power switch OFF to conserve his battery.

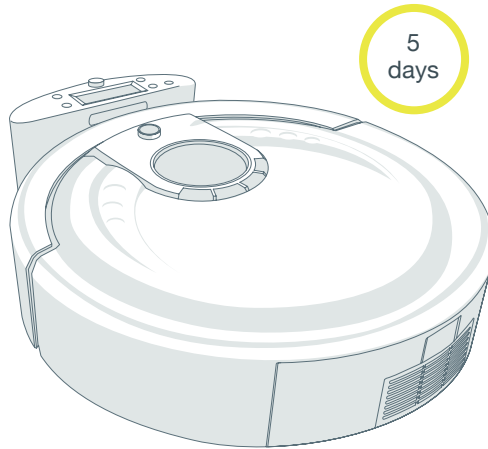

To conserve Bob's battery, flip his power switch OFF when he is away from his charging station.





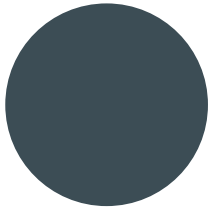
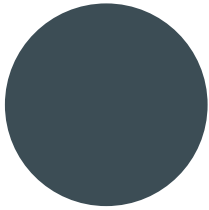
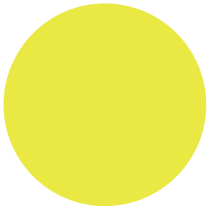
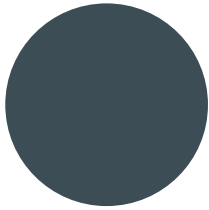
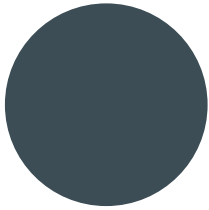
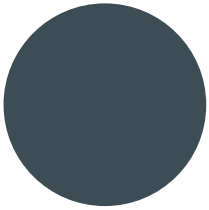
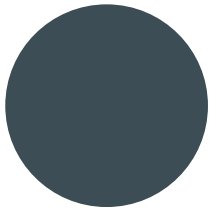
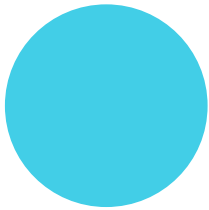
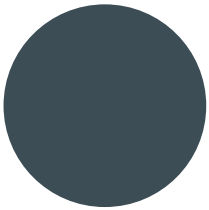

# Cleaning Modes

## Cleaning Modes

### Auto Settings

Bob is equipped with three automatic cleaning modes:

- **Auto 1:** Robot
- **Auto 2:** Quick Clean (30 mins)
- **Auto 3:** Touch Up (15 mins)

On these settings, he will automatically maneuver around your home, cycling through his different cleaning patterns: Spiral Track™, Waffle Track™, and Wall Track™. Choose the setting that best suits your cleaning needs.

## Auto 1: Robot

Bob will thoroughly cover a large area for just over an hour.

To select this setting:

1

Turn Bob ON.

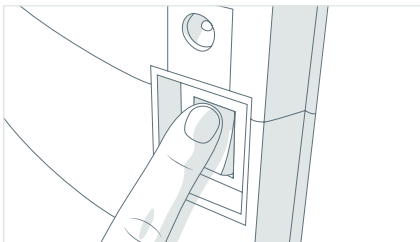

2

Press AUTO on the remote or  on Bob.

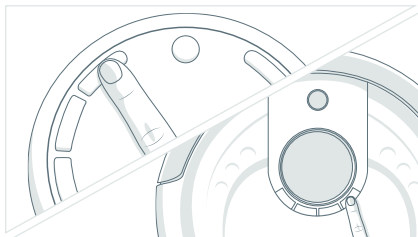

## Auto 2: Quick Clean (30 mins)

Bob will quickly and efficiently clean a medium-sized area for 30 minutes.

To select this setting:

1

Press  on Bob's cover until you see the word AUTO on his screen.

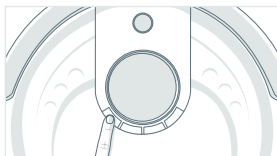

2

Press  until Bob displays the number 02.



3

Press  to confirm your selection.

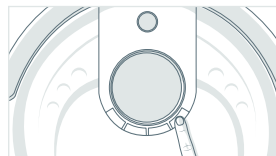

When Bob finishes cleaning, either place him on his charging station or turn his side power switch OFF to conserve battery. If left unattended after his cycle is over, Bob may chirp to draw attention to himself.

### Auto 3: Touch Up (15 mins)

For when you are on-the-go, make Bob dash across a small area for 15 minutes.

To select this setting:



Press  on Bob's cover until you see the word AUTO on his screen.

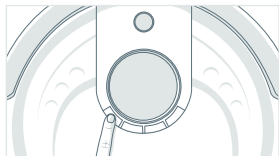

Press  until Bob displays the number 03.

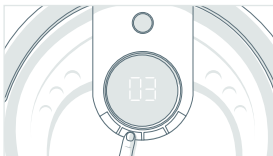

Press  to confirm your selection.

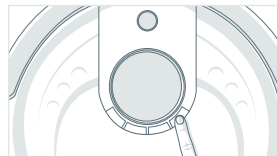

When Bob is done cleaning, either place him on his charging station or turn his side power switch OFF to conserve battery. If left unattended after his cycle is over, Bob may chirp to draw attention to himself.

## Small-area Cleaning: Select Bob's targeted cleaning pattern

1

Press  twice. The word SPOT will appear on Bob's screen.

2

Press  once, twice, or three times to choose Bob's movement pattern.

3

Press  to confirm your selection.

1 indicates Spiral Track™  
2 indicates Waffle Track™  
3 indicates Wall Track™

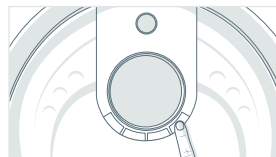
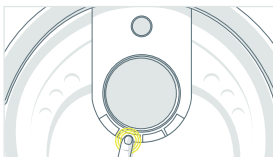
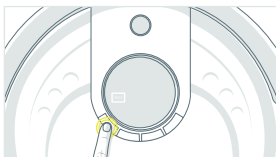

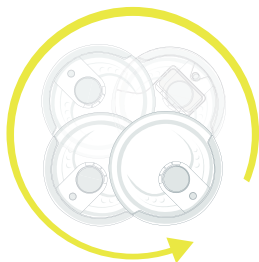

Spiral Track™ (~4 mins)

Bob will target a 5' x 5' spill zone by spiraling outward from the center and then reversing his movements.

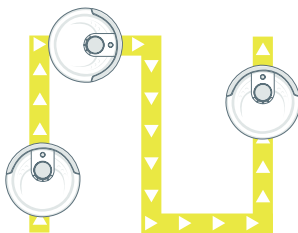

Waffle Track™ (~4 mins)

Bob will target a 6' x 5' spill zone by tracing a grid pattern.

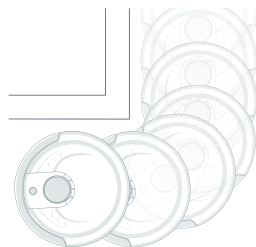

Wall Track™ (~10 mins)

Bob will travel along the perimeter of your home.

## UV Light

The UV light is turned ON by default every time you switch Bob ON. Press the UV button to turn the UV light on or off while Bob is cleaning.

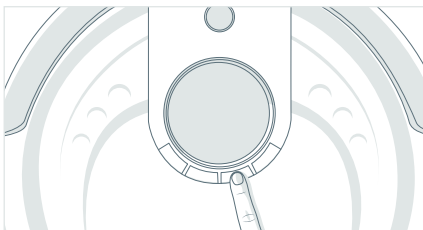

The UV light can't be turned on or off when Bob is standing still. To turn the UV light off or back on, do so while Bob is cleaning.



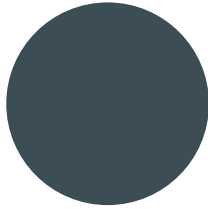
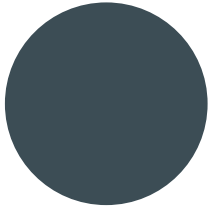
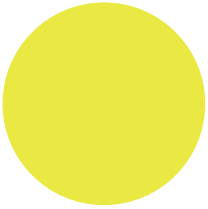
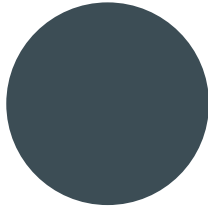
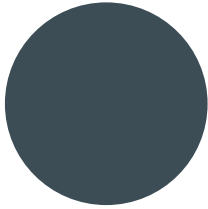
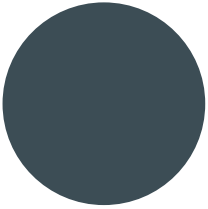
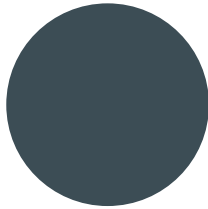
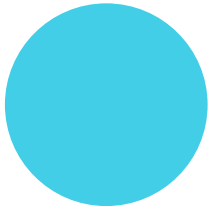
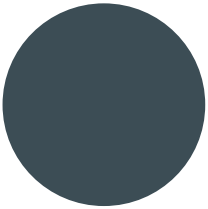

# **Set Bob's Cleaning Schedule**

## Use Bob's Charging Station

Bob can be programmed to start cleaning on the time and days of your choosing through his charging station.

There are 5 buttons on Bob's charging station:

On/Off 1

OK/Cycle 2

Time/Clock 3

Schedule/Program 4

Select/Adjust 5

These buttons are used to program Bob's daily cleaning schedule.

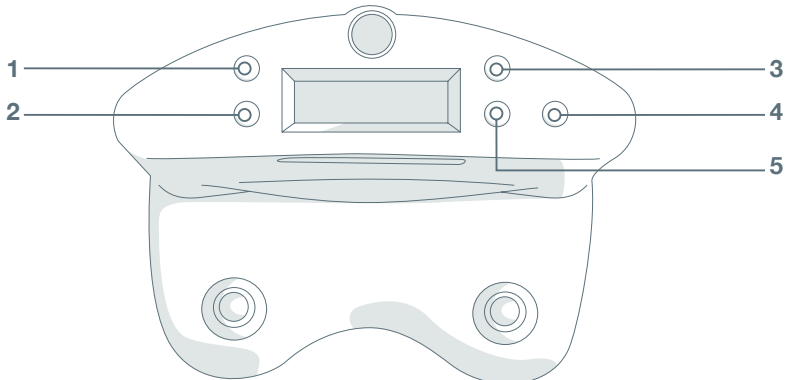

## Set Current Time & Day

Bob uses a 24-hour clock. If you want Bob to start cleaning at 8:00 AM set his schedule time to 08:00. If you want him to start at 8:00 PM, set it to 20:00.

The charging station's default time is 8.00 AM. The station displays 08:00 when it's plugged in for the first time, or after being unplugged for over 8 hours.

### To set the current time and day on Bob's charging station:

Set the minutes:

1

To set the minutes, press the  button once.

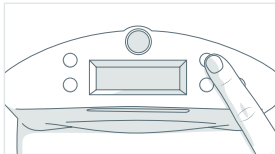

2

The two digits for minutes will blink. Then press the  button to select current minutes.

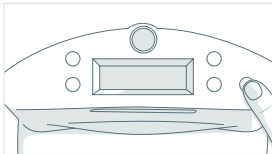

3

Press  to move on to the hour digits.

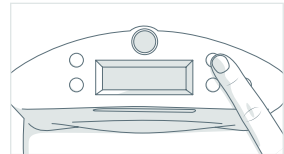

Set the hours:

1

Press the  button until the digits for hours blink.

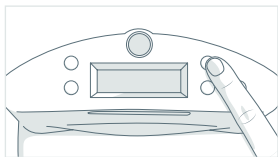

2

Use the  button to select the current hours.

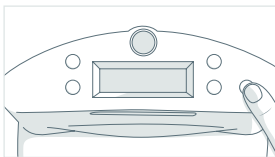

3

Press the  button again to move on to the weekday.

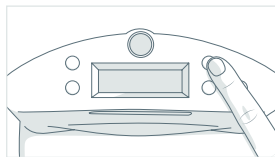

Set the weekday:

1

Press the  button until a weekday symbol blinks.

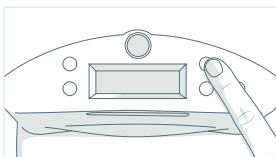

2

Use the  button to select the current day.

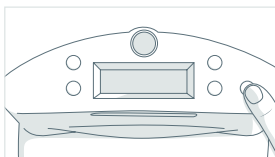

3

Press  to save.

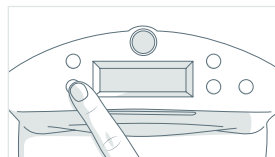

Weekdays are defined as:

Su= Sunday   Mo= Monday   Tu= Tuesday   We= Wednesday  
Th= Thursday   Fr= Friday   Sa= Saturday

Press OK to save each setting within 30 seconds, otherwise the operation will quit without saving.

## Set Bob's Cleaning Schedule

After setting the current time and day on Bob's station, you can program Bob's weekly cleaning schedule.

To set Bob's weekly schedule:

Set the minutes:

1

Press the  button.

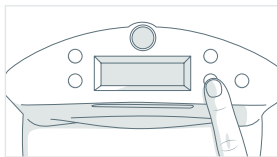

2

The digits for minutes will blink. Use the adjust  button to select the desired minutes.

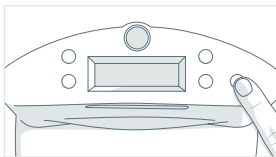

3

Press the  button again to move to the hour digits.

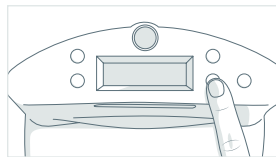

Set the hours:

1

Press the  button until the digits for hours blink.

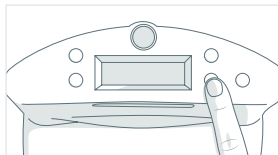

2

Use the  button to select the desired hours.

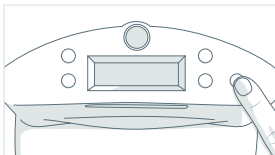

3

Press  to save or press  again to move on to selecting the weekdays.

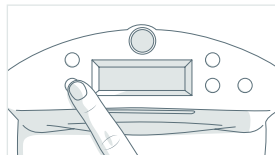



You can choose any and all weekdays for cleaning. Bob starts his cleaning at the selected time (e.g. 14:30) on all programmed days (e.g. Mo, Tu, Th).



Set the weekday(s) you want Bob to clean:

1

Press the  button until the icon Su for the first weekday blinks.

Each weekday blinks for 5 seconds and then remains solid. This indicates that the corresponding day has been selected for cleaning.

2

To move between days, use the  button to move on to the next day. If you would like to skip a certain day, press  again while the weekday icon is still blinking.

To deselect a day, press the power button while the day is blinking.

3

When all desired days are selected, press  to save.

If Bob is scheduled to clean, he will leave his station even if he hasn't finished charging.

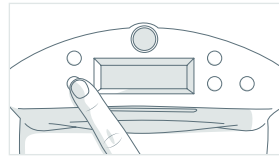
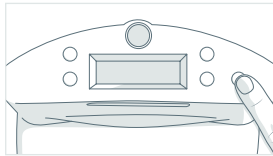
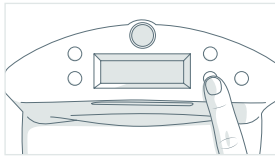

If Bob's charging station is unplugged or turned off for more than 8 hours, his time and schedule will reset to default.

## Back-to-back Cleaning Cycles

Bob's back-to-back cleaning (auto-resume) mode is among the unique features that set him apart from other robotic vacuum cleaners. Auto-resume enables Bob to get back to work as soon as his battery is fully recharged.

To activate back-to-back cleaning cycles:

- Press the  button on Bob's charging station. A broom-shaped sign will light up on station's screen. This means that Bob is on back-to-back cycles mode and will automatically resume cleaning when his battery reaches full charge.

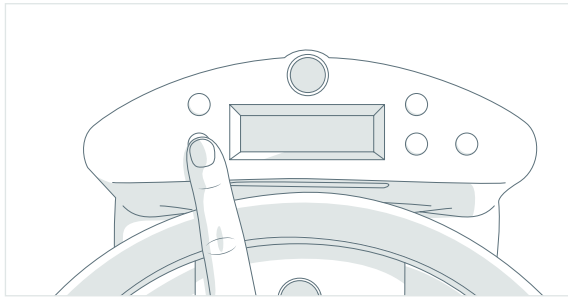

While the broom sign is on, Bob leaves his charging station and begins cleaning EVERY TIME his battery is full. To cancel this setting, press the  button again until the broom-shaped sign disappears. When activated, Bob's back-to-back cycles mode will stay in effect until it is turned off by you, or until the charging station is reset after being unplugged for over 8 hours.

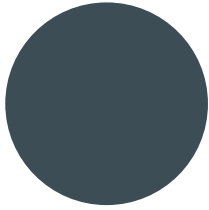
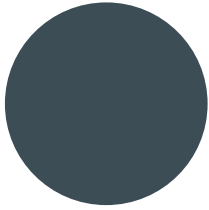
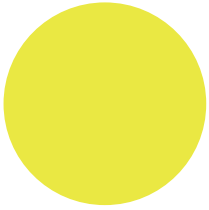
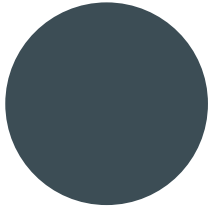
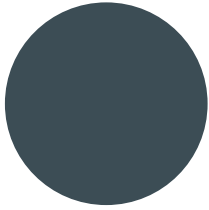
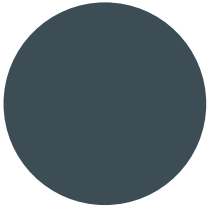
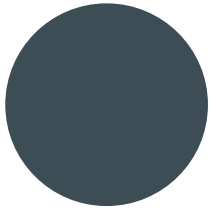
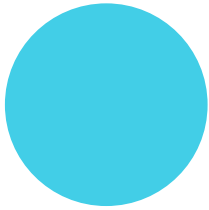
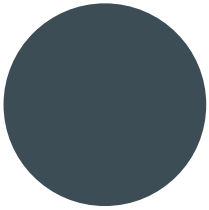

# **Parts & Maintenance**

## Mop

Bob's microfiber mopping cloth can pick up dirt while both wet and dry.

To install Bob's mop attachment:

1

Align the two prongs of the mop attachment to their corresponding spaces between Bob's left and right wheels.

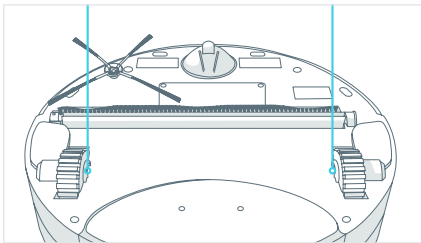

2

Press down on the mop attachment until both sides are secured.

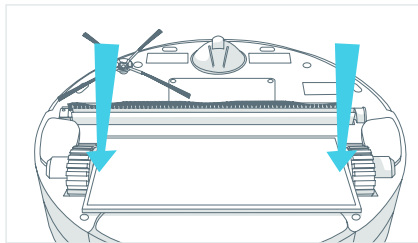

You may dampen Bob's mopping cloth with water or cleaning liquid before placing it on his mop attachment. With his mop installed, Bob can mop, sweep, and vacuum simultaneously.

Remove the mop attachment when Bob is cleaning carpets or rugs. To do so, gently press the tails inward and lift the attachment up.

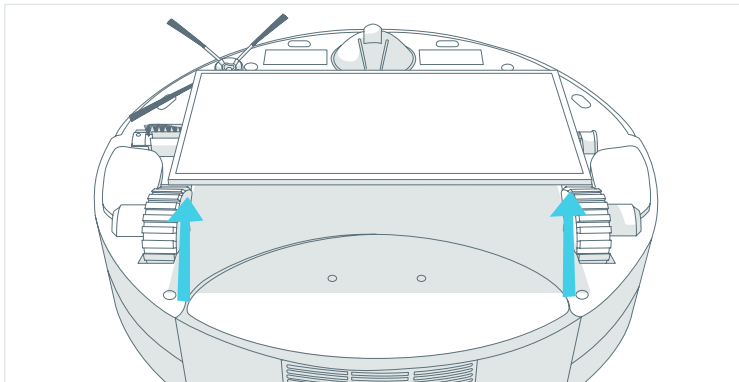

Bob's microfiber mopping cloth can be washed manually or in the washing machine. A spare cloth is provided in Bob's package.

## Dustbin

To empty the dustbin:

1

Push the center button on Bob's back to release the dustbin and pull.

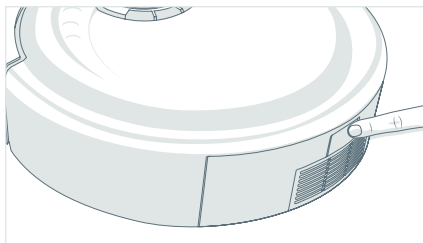

2

Open the transparent gate to empty the bin.

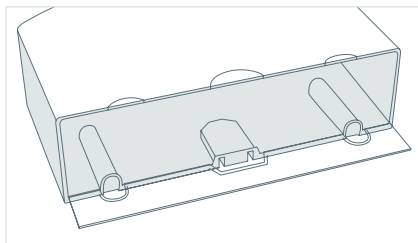

To clean the dustbin:

1

You may wipe the dustbin with a dry cloth or brush it with the cleaning tool.

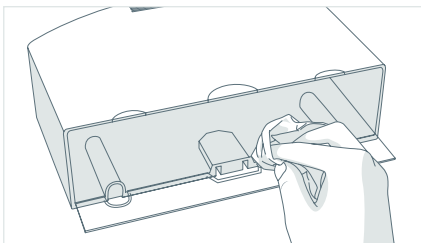

2

When done, replace the transparent gate and slide the dustbin back into Bob.

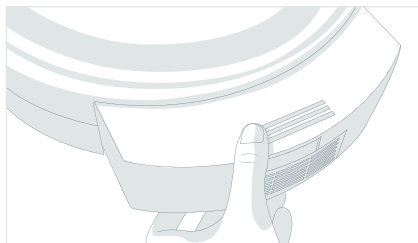

Never wash the dustbin nor fill it with water or any other fluid.



## Filters

Three filters are located inside the dustbin's ceiling. These filters capture fine particles and allergens, and prevent them from escaping the dustbin.

To remove the filters:

1

First eject the dustbin.

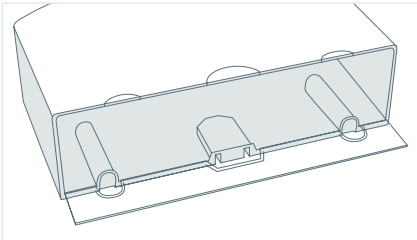

2

Then pull the filter's frame towards you.

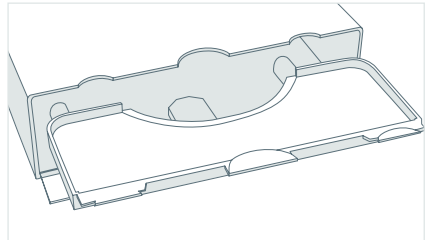

You will see three filter layers:

**Mesh filter 1**

for larger particles

**Electrostatic filter 2**

for fine particles

**HEPA filter 3**

for sub-micron particles

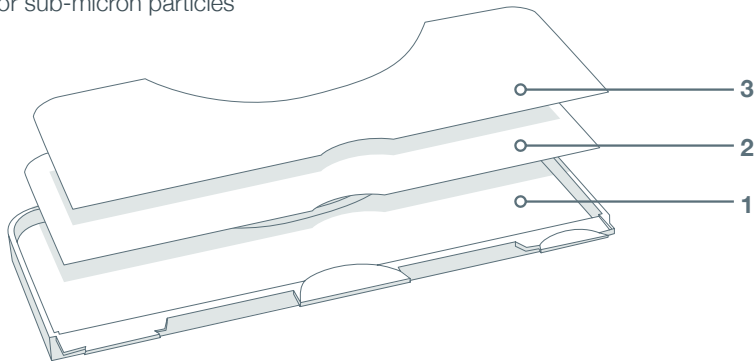

Use the cleaning tool to brush dust off the filters. It is recommended that you change Bob's filters every 6 months, depending on the frequency and intensity of his cleaning.

## Main Brush

It is recommended that you remove and clean Bob's main brush on a weekly basis.

To do so:

1

Remove the screw securing Bob's main brush using a Phillips head screwdriver.

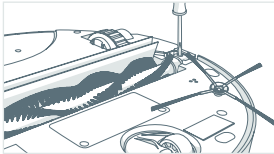

2

Use the cleaning tool to remove hair and debris from both ends of the brush as well as the compartment inside Bob.

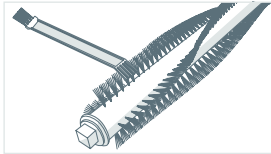

3

You may use a pair of scissors to cut away any hair or threads wrapped around the brush, or a pair of tweezers to remove congestion from the notches where the main brush is held.

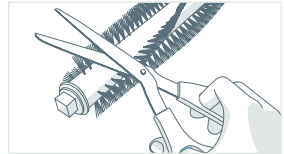

To reinstall the main brush:

1

Replace the end piece and insert the opposite end of the brush into the square indentation inside Bob.

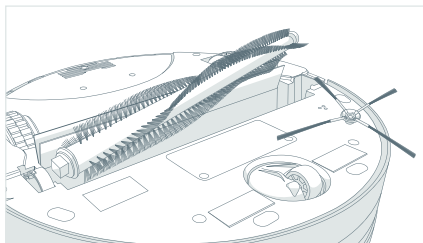

2

Lastly, re-tighten the screw.

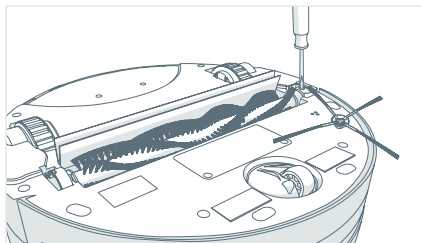

## Side Brush

Bob's side brush extends his reach and allows him to sweep along corners and walls. When Bob is first delivered to you, his side brush is not installed.

To do so:

Use the Phillips head screwdriver and short screw included in Bob's box to secure the side brush into the empty socket on Bob's underside.

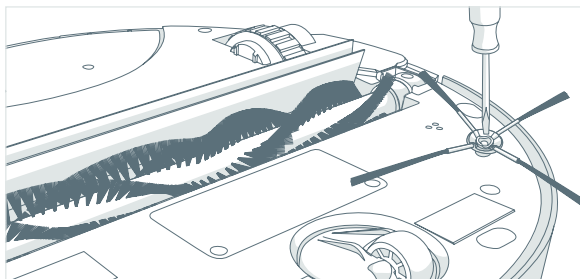

It is recommended that you remove and clean Bob's side brush on a weekly basis.

To do so:

1

Remove the side brush using a Phillips head screwdriver.

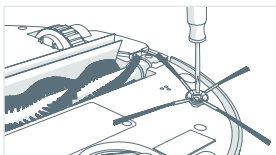

2

Use the cleaning tool to brush off hair tangled around the side brush as well as the socket where the side brush is held.

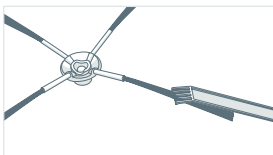

3

Replace the side brush and re-tighten the screw.

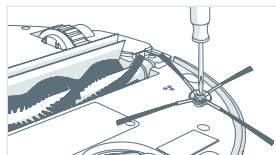

# Battery

## Replacing Bob's Battery

1

Remove the battery cover on Bob's underside using a Phillips head screwdriver.

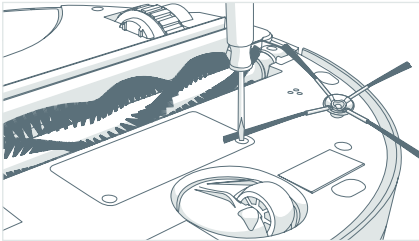

2

Lift the battery out of its compartment, and unplug the connecting wires.

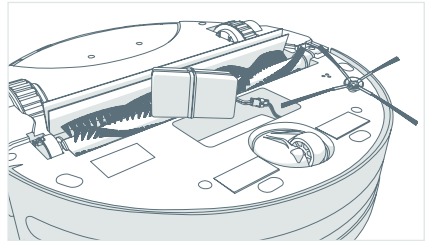

Do not let Bob sit idly with his power switch ON for more than 5 days; switch him OFF to conserve his battery.

3

Plug the new battery in and slide it into the empty compartment.

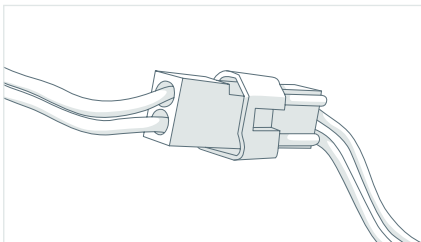

4

Re-tighten the screws on the battery cover.

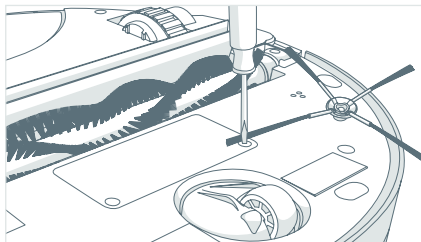

### Storing Bob

If you are not using Bob for an extended period of time, unplug his charging station, remove his battery, and store everything in a dry place at room temperature.

Do not leave  
Bob in direct  
sunlight.



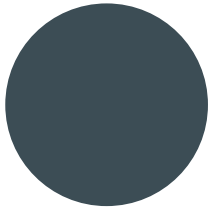
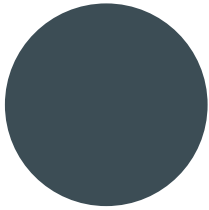
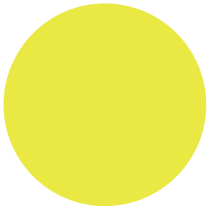
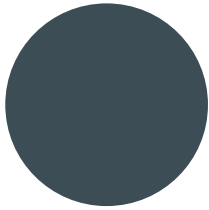
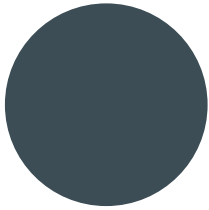
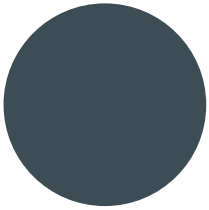
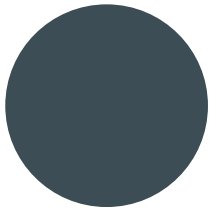
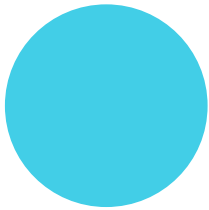
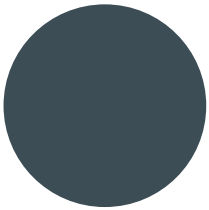

# Sensors

## Cleaning Bob's Sensors

### Edge and wall sensors

Dirt and dust on Bob's wall and edge sensors can reduce his performance. Regularly cleaning these sensors ensures that Bob keeps working at his best.

To do so:

Use a soft cloth slightly moistened with cold water or alcohol to wipe the wall sensors along Bob's bumper and the oval-shaped edge sensors on his underside.

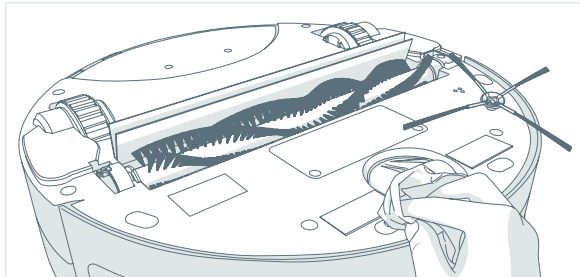

### Dirt Sensors

For a more efficient clean, Bob is equipped with dirt detection sensors. If Bob reaches a particularly dirty spot while cleaning, his dirt detection sensors will activate, the word DIRTY will appear on his screen, and Bob will increase his cleaning intensity.

## Blindfold Stickers

Dark-colored carpeting and certain floor patterns may seem like edges to Bob's ground detection sensors. If you notice that Bob stops with ERROR 04 on your carpet, you may need to "blindfold" Bob by covering his ground detection sensors.

Flip Bob over and use the blindfold stickers that came in Bob's box to blindfold him. Peel off the backs of each blindfold sticker and place one onto each of Bob's 4 sensors.

Make sure each sensor is fully covered. Remember, while Bob is blindfolded, he will not be able to detect stairs or edges!

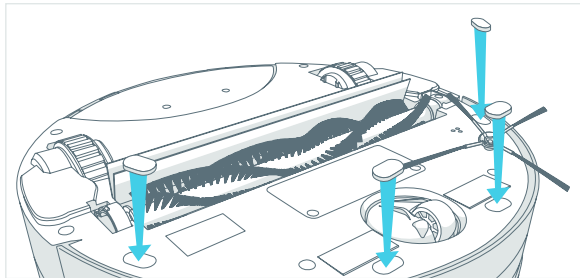

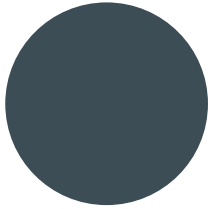
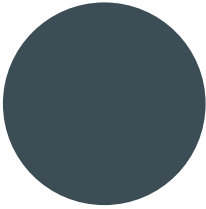
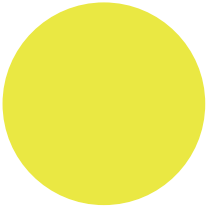
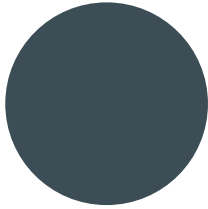
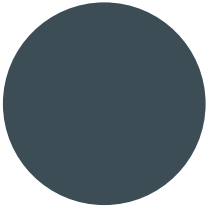
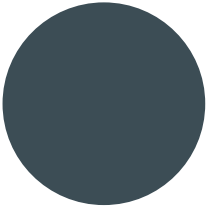
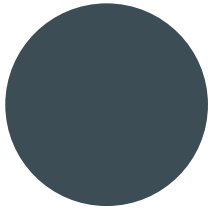
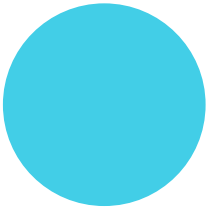
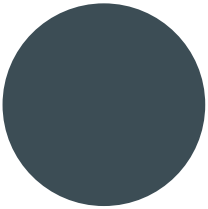

# Troubleshooting

## Error Codes

When Bob faces an uncomfortable situation, he will notify you by displaying ERROR, coupled with a two-digit number on his screen. Each number corresponds to a certain issue Bob is having.

If after attempting the suggested solutions Bob's problem persists, you may want to perform a home checkup test on him (see next section). You may also contact our customer care center at [support@bobsweep.com](mailto:support@bobsweep.com).

Not a fan of reading? Visit [owners.bobsweep.com](http://owners.bobsweep.com) for handy video guides, or scan this QR code:

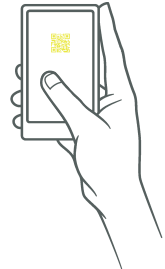

### Error Code 00: Left Wheel

Error Code 00 pertains to an issue with Bob's left wheel.

#### What to do:

Start by checking the left wheel for jamming. Use the cleaning tool or compressed air to remove any dust or debris that may be jamming the left wheel. If this does not solve the problem and Bob still shows Error Code 00, perform a checkup test to see how the wheels respond to the test.

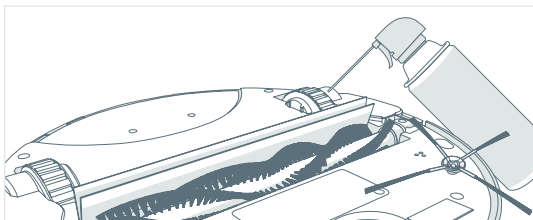

### Error Code 01: Right Wheel

Error Code 01 pertains to an issue with Bob's right wheel.

#### What to do:

Start by checking the left wheel for jamming. Use the cleaning tool or compressed air to remove any dust or debris that may be jamming the left wheel. If this does not solve the problem and Bob still shows Error Code 01, perform a checkup test to see how the wheels respond to the test.



### Error Code 02: Main Brush

Error Code 02 means Bob's main brush is unable to move freely.

#### What to do:

Remove the main brush using a Phillips head screwdriver, and clean it thoroughly from end to end. You may use a pair of scissors to cut hair or thread wrapped around Bob's brush, or a pair of tweezers to remove congestion from the motor area (the square metal indentation where the main brush is held). If Bob displays Trouble Nr 02 while cleaning on a shag carpet or rug, you may remove his main brush and allow him to vacuum without it.

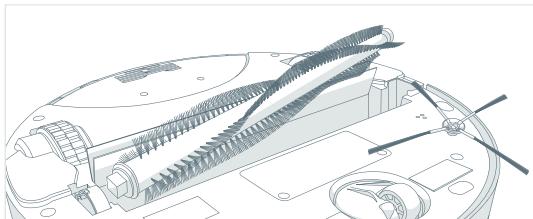

### Error Code 03: Front Wheel

Error Code 03 means Bob's front wheel is unable to move freely.

#### What to do:

Remove debris congesting the front wheel using compressed air and the cleaning tool. If the congestion is not removable from the outside, disconnect the front wheel using a Phillips head screwdriver for leverage, and remove the obstruction. For a comprehensive how-to video, visit [owners.bobsweep.com](http://owners.bobsweep.com).

### Error Code 04: Ground Detection Sensors

Error Code 04 means Bob's ground detection sensors are blocked or dirty. Bob's four, oval-shaped edge sensors are located on his bottom, near his bumper.

#### What to do:

Wipe the sensors using a clean, dry cloth or dust them using compressed air. If Bob displays this Error Code while working on dark-colored carpet or patterned flooring, you may need to blindfold him. See page 69 for instructions.

### Error Code 05: Wall Sensors

Error Code 05 means Bob's wall sensors are blocked or dirty.

#### What to do:

Do a visual check on the transparent stripe on Bob's bumper. If it is too dirty for you to see what is behind it, wipe it with a clean, damp cloth. To ensure nothing is jammed under the bumper, gently tap it and use compressed air to clear it of debris. If the issue persists, try running a checkup test on Bob.

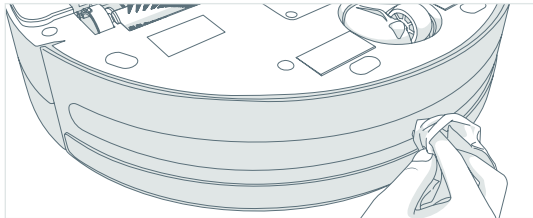

### Error Code 06: Touch Sensors

Error Code 06 pertains to Bob's touch sensors. It is likely that a small piece of debris is trapped under the bumper.

#### What to do:

Slowly and carefully tap on Bob's bumper to clear out any obstructions. Use compressed air to clear it of dust and debris. Press on both ends of the front bumper until you hear a tiny 'click' sound. If the bumper is not clicking on its ends, it is possible that one or more of Bob's touch sensors has a broken arm and needs to be replaced.

### Error Code 07: Main Brush Installation

Error Code 07 means Bob's main brush is not properly installed.

#### What to do:

Use a Phillips head screwdriver to remove the main brush and put it back in place. Make sure the brush's square metal end is well fitted into the corresponding square metal part on the main brush holder.

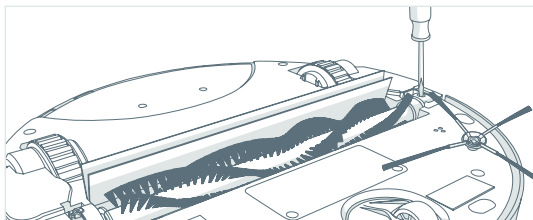

### Error Code 08: Dustbin

Error Code 08 means Bob's dustbin is not properly installed, or his dustbin's metal contact points are dirty.

#### What to do:

Remove Bob's dustbin and empty it. Turn the dustbin around and gently wipe the two metal connectors on its bottom. Lastly, clean the metal contact points inside Bob where the dustbin is inserted.

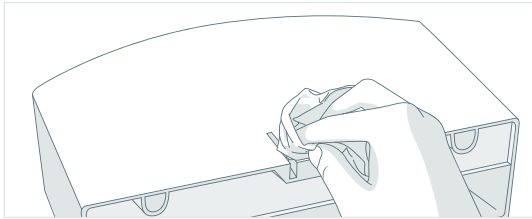

### Error Code 09: Mainboard

Error Code 09 generally means Bob's mainboard is malfunctioning and needs to be replaced.

#### What to do:

Bob likely needs to visit the bObsweep hospital for treatment! But don't worry, Bob's doctors are just an e-mail away. Send a short explanation to [support@bobsweep.com](mailto:support@bobsweep.com), and leave the rest to them!

## Home Checkup Test

If Bob is not performing as well as he used to, you can diagnose the problem with a simple home checkup test.

If Bob fails any part of the checkup test, he may need a replacement part. In this case, please call our customer care center at [1-888-549-8847](tel:1-888-549-8847) for toll-free support in the US and Canada, or email us at [support@bobsweep.com](mailto:support@bobsweep.com).

Put Bob in checkup mode:

1

Flip Bob's power switch OFF and place him on a light-colored surface.

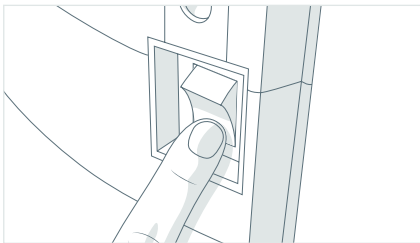

2

While holding down the  button on Bob's cover, turn Bob's power switch ON.

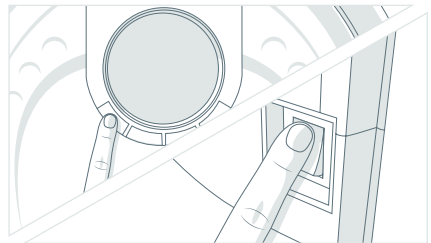

Bob will chirp three times to let you know he is now in checkup mode. The screen will show a word or a number sign. You may release the  button. Do not press any additional buttons.

### Step One: Ground Detection Sensors

Right after Bob enters checkup mode and while Bob is on the floor, look at his screen. You should see four lights indicating AUTO, TIME, SPOT, and UV lit on Bob's display.

If all four lights do not turn on upon entering checkup mode, flip Bob over and wipe his ground detection sensors with a clean cloth. Check again and see if all four lights turn on. If the problem persists, Bob's sensors may need to be replaced. In that case, contact [support@bobsweep.com](mailto:support@bobsweep.com).

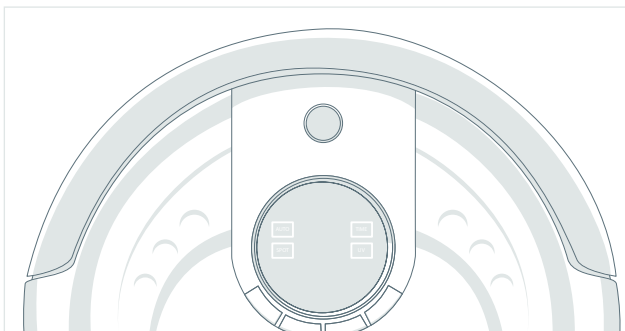

To test the ground detection sensors, lift Bob about 6 inches off the ground (more than 15 cm). You should see the four lights turn off.

If all four lights turn off while Bob is lifted, put Bob back on the floor and continue to the next step without pressing any additional buttons.

## Step Two: Wall Sensors

Use a thick, flat, and white surface to imitate a wall and drag it around Bob's bumper.

The third battery bar, second battery bar, first battery bar, and the words DIRTY and ERROR should light up one-by-one on Bob's screen as you move your imitation wall around his bumper.

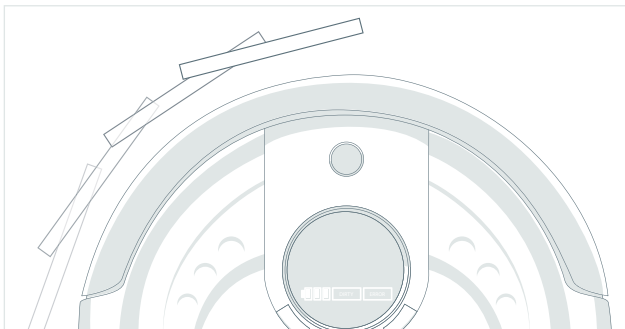

You may now move on to the next step of the checkup test. Do not press any additional buttons.

### Step Three: Touch and Bumper Sensors

To move on to this test, press the  button on Bob's cover twice. Bob's screen will go blank.

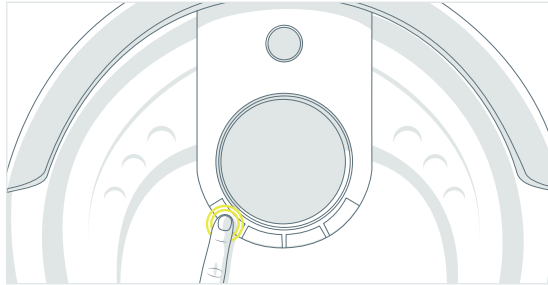

Press on the left side of Bob's bumper and the battery bars should light up on his screen; press on the right side and the word ERROR should light up. If you press the center of the bumper, both the battery bars and ERROR should appear at the same time. If either icon fails to light up, it is likely that Bob needs a new bumper.

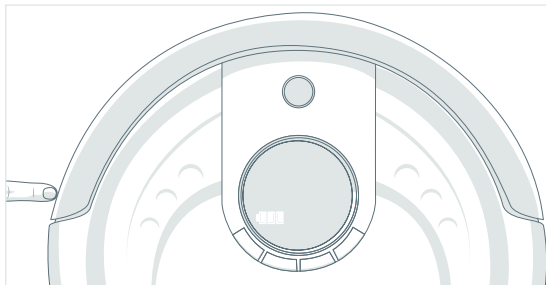



#### Step Four: Display Screen

Press the  button one more time. Each word and icon on the screen should light up in a repeating rotation.

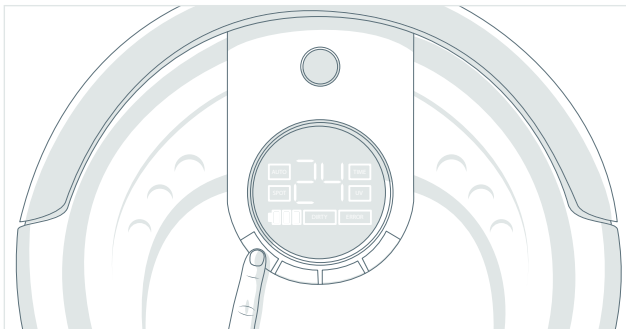

### Step Five: Brush and Suction Power

After the cycle has finished, press the  button again. Now press the  button.

In this mode, the brushes should start rotating and you will feel air flowing from the back of the dustbin. Ignore the signs and numbers on the display in this test mode. If you do not feel air flowing out of the dustbin, then Bob's vacuum motor may need to be replaced.

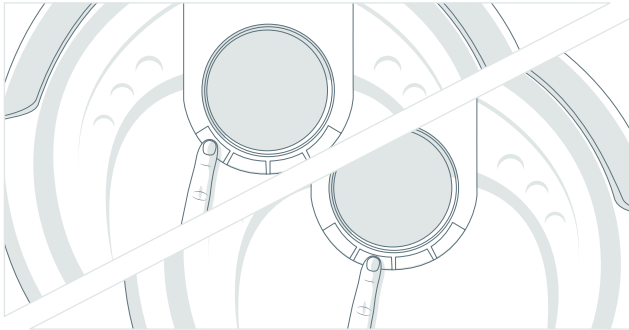

### Step Six: UV Light and Wheels

The final step is to test Bob's UV light and wheels. Lift Bob off the floor to keep him from running away! Then press the  button and his wheels will drive forward.

Next, flip Bob over and you will see his UV lamp light up. Press the  button once more. Bob's wheels will drive backwards and his UV lamp will turn off.

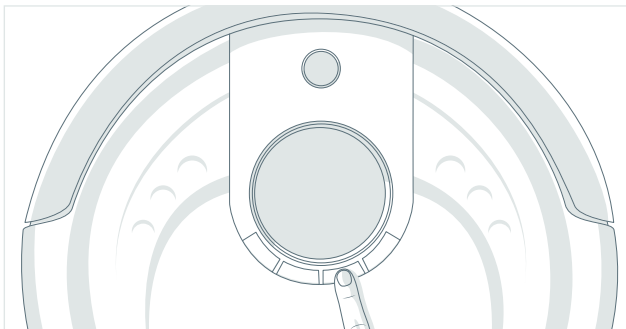

Do not look directly into the UV lamp.

If Bob completes the checkup test without any issues, then his internal parts are working properly! Contact [support@bobsweep.com](mailto:support@bobsweep.com) if you have any questions, as our doctors at the bObsweep hospital are always ready to help!



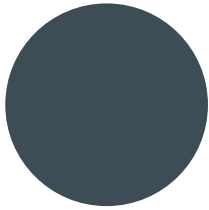
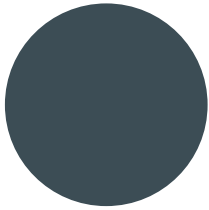
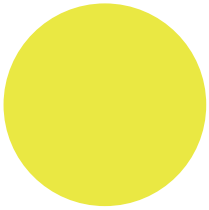
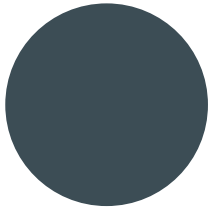
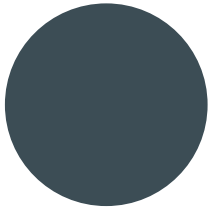
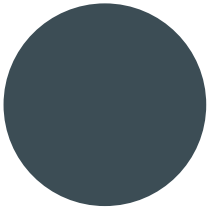
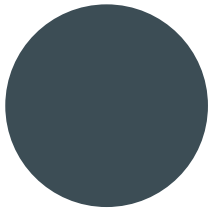
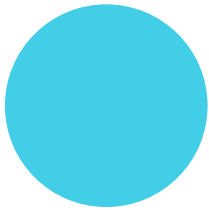
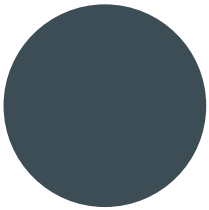

# **Warranty Information**

## Warranty Information

A bObsweep product purchased from an authorized seller and used anywhere in the world includes a 1-year limited warranty, 2-year warranty on the battery, five years of subsidized replacement, and a lifetime of support. The warranty covers labor and all parts, except brushes, filters, and mopping cloths. Postal charges are not covered by the warranty.

Additional coverage plans are available for purchase at [www.bobsweep.com/coverageplan](http://www.bobsweep.com/coverageplan).

Even after Bob's warranty is over, all his replacement parts and his visits to hospital are subsidized between 25%-50% for five years from the date he was first adopted.

To activate Bob's warranty, register him online and keep your original purchase receipt.

To register Bob, visit [www.bobsweep.com/warranties](http://www.bobsweep.com/warranties).

## Bob's Cleaning Behavior

Bob's cleaning pattern may look quite different from the way a human would clean: he may spin in a gradually widening circle, follow along walls, or zigzag across a small area. Sometimes he may seem to be ignoring some spaces or spending too much time on others — but don't worry! Bob's dirt sensors tell him to pay more attention to particularly dusty or soiled areas. Rest assured, Bob will efficiently clean your home within the course of a full cycle — just check his dustbin for the evidence!

It is best to let Bob work in his own way, even if his movements appear odd. Moving him around, manipulating his movements, or picking him up may confuse him and disrupt his cycle.

If you wish to control Bob's movements manually, you may use the navigational buttons on his remote. If your rooms are divided by higher ledges than Bob is able to climb.



## Bob's Challenges

### Unique Furniture

Bob is designed to maneuver around furniture of most shapes and sizes, but certain configurations may confuse him temporarily. Bob may sometimes find it difficult to clean under chairs with narrow legs, or furniture that is too low for his bumper sensors to detect. Specialty furniture, such as desk chairs with wheels or stools with circular bases, may also confuse him for a moment — but don't worry, Bob usually finds his way around with time.

### Blindfold Stickers

Bob uses infrared light to detect edges and stairs; because dark-colored carpet absorbs most light, it may seem like an edge to Bob's sensors. If Bob continually displays ERROR 04 on his screen while working on dark-colored carpet, simply cover the four ground detection sensors on his underbelly with the blindfold stickers that came in his box. Just remember that when Bob is "blindfolded" he will not be able to detect edges or stairs!

### Main Brush

Bob's main brush, which is designed to reach deep into carpet, may also have trouble turning on rugs with long fibers or fringes. You may remove Bob's main brush and allow him to vacuum without it when this happens.

## Mop

Bob's mop, which is attached to his bottom, is designed to sit flat against the floor and leave behind a clean trail. Because of this, Bob may have a tough time climbing over elevated surfaces while mopping. Make sure to remove Bob's mop when he is not cleaning smooth surfaces such as tile or hardwood.

## Inclines

Sometimes Bob will attempt to drive up angled surfaces, getting stuck for a few minutes before deciding to clean somewhere else. This is because Bob wants to cover every spot in your home and will try his hardest to overcome any obstacle!

As long as Bob does not indicate on his screen that there is a problem, let him find his own way around your home and continue cleaning. Take note of the areas Bob finds the most challenging, and if possible spread or adjust some of your furniture accordingly.

## FAQs

### 1. Where can I find Bob's training videos?

Bob's "how-to" videos can be found at Bob's owners' corner: [owners.bobsweep.com](https://owners.bobsweep.com).

### 2. How long should Bob's battery last?

The exact time depends on the type of surface Bob is cleaning as well as the age of the battery. Generally, the smoother the surface (hardwood or tile for example), the longer the battery will last. When fully charged, a new Bob usually cleans between 45 to 90 minutes.

### 3. How do I know that Bob is fully charged and ready to clean?

When Bob charges using the wall adapter or charging station, the battery bars flash on his display screen. As soon as Bob's battery is fully charged, these bars will remain solid.

### 4. How often should I empty the dustbin?

Bob's dustbin has a 1000 mL capacity — three times larger than most robotic vacuum cleaners on the market today! This means you may not need to empty the dustbin immediately after every cleaning. Depending on the size of the room and the amount of particles piled up, Bob can perform up to around six cleaning cycles before he fills his dustbin. Simply remove the dustbin and check to see if emptying is necessary.

### 5. How often should I clean Bob's brushes?

Bob's brushes do a lot of the work picking up hair and larger debris, so it is recommended that you clean the main and side brushes every 1 to 4 uses. If you notice a thick covering of hair, dust, and debris on his brushes, remove and clean them. Remember to clean the notches that hold Bob's brushes in place on his interior. This assures they stay in good condition for a long time.

## 6. My Bob won't turn on no matter what I do.

If Bob only charged for a short amount of time and does not start after using his ON/OFF switch or his charging station, it's likely that his battery has drained too low to operate. To recharge him, unplug the adapter that normally attaches to the charging station and plug it directly into the inlet on Bob's side. Let Bob recharge overnight before using again. After this procedure, you will be able to charge Bob using the charging station. If you place Bob on his charging station, always make sure to turn him ON first, to activate the charging plates on his bottom. When Bob charges, the battery bars on his display screen blink.

## 7. Why is my Bob beeping?

If Bob is stationary and left ON without cleaning or charging, he will beep once every five minutes to alert you that his battery is draining. Press the power button on the remote to put Bob in standby mode or turn him off completely with his side power button. You will have to switch this button ON the next time you want Bob to clean. Bob also beeps when he encounters a problem cleaning and needs assistance. Along with his sounds, you will see an Error Code on the digital display which lets you know why Bob has stopped. Consult this manual's Troubleshooting section to resolve Bob's error messages.

## 8. Bob is having trouble finding his charging station. Where is the best place to put his station?

For Bob to find his charging station, he needs to face it directly. Bob will find his station more easily if it you place it near the perimeter of the room with plenty of space in front of it, so that he may detect the station from afar. In order for Bob to dock properly, place the charging station against the wall on a flat surface like hardwood or tile flooring instead of carpet. To facilitate Bob's work, find a spot for the charging station where Bob has a higher chance of passing through.

### 9. I am having problems removing Bob's brush.

If the main or side brushes are difficult to remove, it is likely because hair, string, or other debris have been caught in them and are clogging the areas where they attach to bObsweep. You can use scissors to cut the hair wrapped around either brush, until you are able to remove it. You may need to gently pull the main brush up or down to reach the corners, but do not force the brushes out as this can damage them.

### 10. Bob gets stuck under my furniture or travels over wires that tangle up his brush. How can I stop him from going into these areas?

If Bob maneuvers under a piece of furniture and there is only one open entrance, he may need a few minutes to figure out how to escape on his own. You will not need to assist him when this happens, unless Bob stops cleaning completely and starts beeping.

### 11. Why does Bob start cleaning when I did not tell him to clean?

Bob will start up on his own when he is scheduled to clean, or when his auto-resume feature is enabled. Bob's weekly cleaning schedule is displayed on his charging station. Bob will automatically start cleaning on the time and days of the week he is scheduled to clean. A bell shaped icon of Bob's station means Bob has a scheduled cleaning coming up. Bob works on a 24 hour clock, so if he is scheduled to clean at 01:00, then he will begin working at 1 am; if he is scheduled to clean at 13:00, then he will begin working at 1 pm.

## 12. When should I use different cleaning modes?

Auto/Robot mode is Bob's default mode and gives him enough time to thoroughly cover a large area. If you would like to clean a smaller area, you may use Quick Clean mode, which lasts 30 minutes, or Touch Up mode, which lasts 15 minutes.

Waffle Track™ and Spiral Track™ are best used when cleaning a small spill. When Waffle Track™ is selected, Bob travels in a grid pattern; when Spiral Track™ is selected, Bob travels in a gradually widening circle. Select Wall Track™ to make Bob travel along the edges of your room.

## 13. Bob is stopping and showing ERROR. on the screen. How can I fix this?

Bob's Error Code notifies you of the specific reason his work has been interrupted. This feature allows you to identify the source of the problem quickly. A Error Code rarely signals a defect and can be solved with simple procedures. Along with the word "ERROR" there will also be a two-digit number on the center of Bob's screen (where Bob's cleaning minutes can be seen). The numbers range from 00 to 10. Each number represents an issue with a specific mechanical part on Bob. Refer to the Troubleshooting section of this manual (page 70) for the cause of the problem as well as its solution.

## 14. What is the best way to clean Bob's wheels?

Use the cleaning tool or compressed air to clear the creases of the wheels. For a more thorough clean, wipe the sides and bottoms of the wheels as they spin during checkup mode (see the Home Checkup Test section of this manual).

15. My Bob just stopped while cleaning and the screen went off. What do I do next?

Like other electronic devices with a CPU (computers, smartphones, etc.), Bob may experience a momentary halt in his operating system. You can usually get Bob back to work by simply turning his power switch OFF and ON again. If this does not solve the issue, Bob might need a manual restart. You can restart him by flipping his power switch OFF and plugging the charging adapter directly into the inlet on his side. Leave him to charge overnight to fully refresh his system.

16. I have a question and need to contact Bob's support team. How do I do that?

Our devoted team is always eager to help you! You can reach us by phone or e-mail.

Call us toll free [1-888-549-8847](tel:1-888-549-8847) for support in Canada and the United States, or e-mail us at [support@bobsweep.com](mailto:support@bobsweep.com). Our goal is to get back to you within a day.

To watch Bob's how-to, repair, and troubleshooting videos; order parts; and connect with your extended bObsweep family members, visit [owners.bobsweep.com](http://owners.bobsweep.com).





# End User License Agreement for Bobsweep Software and bObsweep

**IMPORTANT - READ BEFORE USING.** Do not use the robot (“Bobsweep”) accompanying this license agreement (“Agreement”) until you have carefully read and agreed to the following terms and conditions.

By using the Bobsweep, you agree to the terms of this End User License Agreement (“EULA”) and any amendment or addenda accompanying this Agreement. If you do not agree to the terms of this EULA, you may not use the Bobsweep. The Bobsweep contains an electronic and software interface that allows you to control or modify its behavior, and remotely monitor its sensors. THIS IS A LEGAL AGREEMENT. BY ACCESSING AND USING THE PRODUCT AND PRODUCT SOFTWARE, YOU ARE ACCEPTING AND AGREEING TO THIS EULA ON BEHALF OF YOURSELF OR THE ENTITY YOU REPRESENT IN CONNECTION WITH THE ACCESS. YOU REPRESENT AND WARRANT THAT YOU HAVE THE RIGHT, AUTHORITY, AND CAPACITY TO ACCEPT AND AGREE TO THIS EULA ON BEHALF OF YOURSELF OR THE ENTITY YOU REPRESENT. YOU REPRESENT THAT YOU ARE OF SUFFICIENT LEGAL AGE IN YOUR JURISDICTION OR RESIDENCE TO USE OR ACCESS THE PRODUCT SOFTWARE AND TO ENTER INTO THIS EULA. IF YOU DO NOT AGREE WITH ANY OF THE PROVISIONS OF THESE TERMS, YOU SHOULD CEASE USING THE PRODUCT AND PRODUCT SOFTWARE. Terms and Conditions

**LICENSE:** Subject to all of the terms of this Agreement, Bobsweep Inc. (“Bobsweep”) grants to you one (1) revocable, royalty-free, personal, non-exclusive, nontransferable, non-assignable, non-commercial intellectual property license to use the Bobsweep software contained on the Bobsweep, including the protocol for communicating with the Bobsweep software contained on the Bobsweep (“Bobsweep Software”), to use the Bobsweep.

**NONCOMMERCIAL LICENSE:** You may use the Bobsweep Software and the Bobsweep only for personal, noncommercial, educational, and research purposes. The Bobsweep Software and the Bobsweep may not be used for any other purpose, whether “for prot.” or “not for prot.” Any work performed or produced using the Bobsweep, including Your Software, cannot be performed or produced for the benefit of other parties for a fee, compensation, or any other reimbursement or remuneration. A separate license is required for each additional use and/or individual user in all other cases. If you are an entity, Bobsweep grants you the right to designate one individual within your organization to have the sole right to use the Bobsweep Software and the Bobsweep in the manner provided above. **RESTRICTIONS:** You agree not to: (i) use or copy the Bobsweep Software or the Bobsweep except as provided in this Agreement; (ii) rent or lease the Bobsweep Software or the Bobsweep to any third party; (iii) assign this Agreement or transfer the Bobsweep Software or the Bobsweep except as provided in this Agreement; (iv) modify, adapt, or translate the Bobsweep Software or the Bobsweep in whole or in part except as expressly provided in this Agreement; (v) reverse engineer, reverse compile, or disassemble the Bobsweep Software or the Bobsweep; or (vi) distribute, sublicense or transfer the source code form of Your Software and derivatives thereof to any third party except as provided in this Agreement. **YOUR SOFTWARE :** Use and distribution of any software that you create for your Bobsweep (“Your Software”) is also subject to the following limitations: You (i) shall be solely responsible for any update or support obligation or other liability which may arise from your use or distribution, (ii) shall not make any statement that Your Software is “certified,” or that its performance is guaranteed, by Bobsweep, (iii) shall not use Bobsweep’s name or trademarks, (iv) shall prohibit disassembly and reverse engineering of the Bobsweep Software and the Bobsweep, (v) shall not publish reviews of Bobsweep products designated as beta without written permission from Bobsweep, and (vi) shall indemnify, hold harmless, and defend Bobsweep and its suppliers from and against any claims or lawsuits, including attorney’s fees, that arise or result from Your Software, including your use and your distribution. **TITLE:** Title to the Bobsweep Software remains with Bobsweep or its suppliers. The Bobsweep Software is licensed, not sold. Except as expressly provided herein, Bobsweep does not grant any express or implied right to you under Bobsweep patents, copyrights, trademarks, or trade secret information. You will not remove any copyright or patent notice from the Bobsweep Software or the Bobsweep. **ONE-TIME TRANSFER:** The initial user of the Bobsweep Software and the Bobsweep may make a one-time permanent transfer of this Agreement, the Bobsweep Software, and the Bobsweep to another end user, provided that the initial user retains no copies of the Bobsweep Software and the Bobsweep.

This transfer must include the Bobsweep Software, the Bobsweep, and all of the materials accompanying the Bobsweep (including all component parts and printed materials, any upgrades, and this End User License Agreement document). The transfer may not be an indirect transfer, such as a consignment. Prior to the transfer, the end user receiving the Bobsweep Software and the Bobsweep must agree to all the terms of this Agreement. NO WARRANTY AND LIMITED REPLACEMENT: EXCEPT AS STATED IN THE LIMITED WARRANTY TO THE ORIGINAL PURCHASER, THE BOBSWEEP SOFTWARE AND THE BOBSWEEP ARE PROVIDED "AS IS" WITH NO WARRANTIES, EXPRESS OR IMPLIED, INCLUDING BUT NOT LIMITED TO ANY IMPLIED WARRANTY OF MERCHANTABILITY, FITNESS FOR A PARTICULAR PURPOSE, NON-INFRINGEMENT OF INTELLECTUAL PROPERTY RIGHTS, OR ANY WARRANTY OTHERWISE ARISING OUT OF ANY PROPOSAL, SPECIFICATION, OR SAMPLE. NO ORAL OR WRITTEN INFORMATION OR ADVICE GIVEN BY BOBSWEEP OR ITS AGENTS SHALL CREATE A WARRANTY. If the Bobsweep Software or the Bobsweep is found to be defective in material or workmanship under normal use for a period of one (1) year from the date of receipt, Bobsweep's entire liability and your exclusive remedy shall be the replacement of the Bobsweep Software or the Bobsweep.

This offer is void if the defect results from accident, abuse, misapplication, or software that you developed for your Bobsweep. Any updates or supplements to the Bobsweep Software or the Bobsweep provided to you after the expiration of the one (1) year period are not covered by any warranty or condition, express, implied or statutory. SOME JURISDICTIONS DO NOT ALLOW THE EXCLUSION OF IMPLIED WARRANTIES, SO THE ABOVE EXCLUSION MAY NOT APPLY TO YOU. LIMITATION OF LIABILITY: THE ABOVE REPLACEMENT PROVISION IS THE ONLY WARRANTY OF ANY KIND. BOBSWEEP OFFERS NO OTHER WARRANTY EITHER EXPRESS OR IMPLIED INCLUDING THOSE OF MERCHANTABILITY, NON INFRINGEMENT OF THIRD- PARTY INTELLECTUAL PROPERTY OR FITNESS FOR A PARTICULAR PURPOSE. NEITHER BOBSWEEP NOR ITS SUPPLIERS SHALL BE LIABLE FOR ANY DAMAGES WHATSOEVER (INCLUDING, WITHOUT LIMITATION, VICARIOUS LIABILITY, CONSEQUENTIAL DAMAGES, INCIDENTAL DAMAGES, DAMAGES FOR LOSS OF BUSINESS PROFITS, BUSINESS INTERRUPTION, LOSS OF BUSINESS INFORMATION, OR OTHER LOSS) ARISING OUT OF THE USE OF OR INABILITY TO USE THE BOBSWEEP SOFTWARE, THE BOBSWEEP, OR SOFTWARE THAT YOU DEVELOPED FOR YOUR BOBSWEEP, EVEN IF BOBSWEEP HAS BEEN ADVISED OF THE POSSIBILITY OF SUCH DAMAGES. BECAUSE SOME JURISDICTIONS PROHIBIT THE EXCLUSION OR LIMITATION OF LIABILITY FOR CONSEQUENTIAL OR INCIDENTAL DAMAGES, THE ABOVE LIMITATION MAY NOT APPLY TO YOU UNAUTHORIZED USE: THE BOBSWEEP SOFTWARE AND THE BOBSWEEP ARE NOT DESIGNED, INTENDED, OR AUTHORIZED FOR USE IN ANY AERONAUTICAL, NUCLEAR, MEDICAL, LIFE SAVING OR LIFE SUSTAINING SYSTEMS, OR FOR ANY OTHER APPLICATION IN WHICH THE USE OF THE BOBSWEEP SOFTWARE OR THE BOBSWEEP COULD CREATE A SITUATION WHERE PERSONAL INJURY OR DEATH MAY OCCUR. Should you use the Bobsweep Software or Bobsweep for any such unintended or unauthorized use, you shall indemnify and hold harmless Bobsweep and its ocers, subsidiaries and aliates against all claims, costs, damages, and expenses, and reasonable attorney fees arising out of, directly or indirectly, any claim of product liability, personal injury or death associated with such unintended or unauthorized use, even if such claim alleges that Bobsweep was negligent regarding the design or manufacture of the Bobsweep Software, the Bobsweep, or any part or portion thereof.

USER SUBMISSIONS: You agree that any material, information or other communication, including all data, images, sounds, text, and other things embodied therein, that you transmit or post to a Bobsweep website or provide to Bobsweep ("Communications") will be considered non-confidential. Bobsweep will have no confidentiality obligations with respect to the Communications. You agree that Bobsweep and its designees will be free to copy, modify, create derivative works, publicly display, disclose, distribute, license and sublicense through multiple tiers of distribution and licensees, incorporate and otherwise use the Communications, including derivative works thereof, for any and all commercial or non-commercial purposes without the payment of any royalty to you, and that such license will survive the termination of this Agreement.

**TERMINATION:** This Agreement becomes effective on the date you accept this Agreement and will continue until terminated as provided for in this Agreement. You may terminate this Agreement voluntarily at any time. Bobsweep may terminate this Agreement at any time if you are in breach of any of its terms and conditions, and may refuse to license the Bobsweep Software or the Bobsweep to you after termination. Upon termination by either party, you will immediately return to Bobsweep or destroy the Bobsweep Software and the Bobsweep and all your copies thereof. Articles 5 and 7 through 17 of this Agreement shall survive such termination. U.S. **GOVERNMENT RESTRICTED RIGHTS:** The Bobsweep Software and the Bobsweep are provided with "RESTRICTED RIGHTS." Use, duplication or disclosure by the Government is subject to restrictions set forth in FAR52.227-14 and DFAR252.227-7013 et seq. or its successor. Use of the Bobsweep Software or the Bobsweep by the Government constitutes acknowledgment of Bobsweep's rights in them.

**NO EXPORT:** You may not export the Bobsweep Software or the Bobsweep in violation of applicable export laws.

**INTERPRETATION:** The provisions of this Agreement are severable. If any provision of this Agreement is held to be unenforceable, such provision shall be reformed only to the extent necessary to make it enforceable. Any law or regulation which provides that the language of a contract shall be construed against the drafter shall not apply to this Agreement.

**INTEGRATION:** This Agreement represents the complete agreement concerning the subject matter hereof, and any and all understandings, conversations and communications, proposals, and counterproposals, oral and written (including any draft of this Agreement) are merged into and superseded by this Agreement and shall be of no force or effect, except as expressly provided herein. No such understandings, conversations, communications, proposals, counterproposals or drafts shall be referred to in any proceeding concerning this Agreement. Further, no understanding contained in this Agreement shall be modified, altered or amended, except by a writing signed by the party against whom enforcement is sought.

**ARBITRATION:** All disputes relating to this Agreement (excepting any dispute relating to intellectual property rights) shall be subject to and binding arbitration, with the losing party paying all costs of arbitration. Any arbitration relating to this Agreement shall be held in California, under the auspices of an arbitrator selected by Bobsweep. Any litigation relating to this Agreement shall be subject to exclusive venue and jurisdiction in the federal and state courts of California, with the losing party responsible for costs, including without limitation, court costs and reasonable attorneys fees and expenses.

**APPLICABLE LAWS:** Any claim arising under or relating to this Agreement shall be governed by the internal substantive laws of the Commonwealth of California, without regard to its principles of conflict of laws. The application of the United Nations Convention on Contracts for the International Sale of Goods is expressly excluded.



**bob**sweep