

# HANOVER®

## Hanover Outdoor Furniture



### **IMPORTANT**

If you have any problems with this product (missing or damaged parts, assembly issues, etc.),

**PLEASE DO NOT RETURN TO THE RETAILER/STORE**

from where you purchased the product.

Please call our Toll-Free Customer Service Hotline at: **1-800-416-3511**

Between 9:00 AM and 5:00 PM Eastern Time, Monday through Friday

Or visit our website at: **[www.hanover-products.com](http://www.hanover-products.com)**

To expedite any future warranty claims, please retain the Instruction Sheet, Warranty Card and receipt for future use.

For additional on-line support on assembly, troubleshooting and care & maintenance of your outdoor furniture, please visit our website at: **[www.hanover-products.com](http://www.hanover-products.com)**.

# ASSEMBLY INSTRUCTIONS

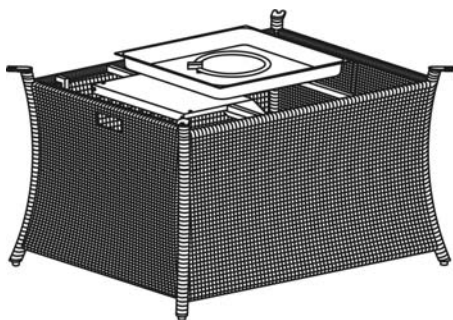

CSA Model 98910



ARL11103

Installer: Leave these instructions with consumer.

Consumer: Keep these instructions for future reference.



## DANGER

If you smell gas:

1. Shut off gas to the appliance.
2. Extinguish any open flame.
3. If odor continues, keep away from the appliance and immediately call your gas supplier or fire department.



## WARNING:

Improper installation, adjustment alteration, service or maintenance can cause injury or property damage. Read the installation, operating and maintenance instructions thoroughly before installing or servicing this equipment.



## WARNING

Do not store or use gasoline or other flammable vapors and liquids in the vicinity of this or any other appliance. An LP-cylinder not connected for use shall not be stored in the vicinity of this or any other appliance.



## WARNING: For Outdoor Use Only

FOR USE WITH 20LB (9KG) PROPANE CYLINDER WITH TYPE 1 CONNECTION OR FOR USE WITH NATURAL GAS AFTER CONVERSION KIT IS INSTALLED (MUST BE PROFESSIONALLY INSTALLED).



## DANGER

### CARBON MONOXIDE HAZARD



This appliance can produce carbon monoxide which has no odor.

Using it in an enclosed space can kill you.

Never use this appliance in an enclosed space such as a camper, tent, car or home.

## WARNING:

USE FACTORY APPROVED REPLACEMENT PARTS AND ACCESSORIES ONLY. USE OF UNAPPROVED PART OR ACCESSORIES CAN VOID THE WARRANTY ON THIS PRODUCT AND RESULT IN A HAZARDOUS CONDITION. PLEASE CONTACT US FOR INFORMATION REGARDING REPLACEMENT HOSES, THERMOCOUPLES, ELECTRODES, IGNITION MODULES, LAVAROCKS, LOGS, FIRE ICE, ETC.



Questions, Problems, Missing Parts? Before returning to your retailer, call our customer service department in the US and Canada at 1-800-416-3511, Monday-Friday, 9 a.m. – 5 p.m. Eastern Time.

# TABLE OF CONTENTS

Important Safety Information	3
Information about Propane	4
Specifications	4
Parts List	5
Installation	6
Natural Gas Conversion	8
Lighting Instructions	9
Maintenance	9
Batteries	9
Troubleshooting Guide	10
Warranty	11

# IMPORTANT SAFETY INFORMATION

The installation must conform with local codes or, in the absence of local codes, with the National Fuel Gas Code, ANSI Z223.1/NFPA 54; International Fuel Gas Code. ; Natural Gas and Propane Installation Code, CSA B149.1; or Propane Storage and Handling Code, B149.2, as applicable.

The appliance and its appliance main gas valve must be disconnected from the gas supply piping system during any pressure testing of that system at test pressures in excess of 1/2 psi (3.5kPa).

The appliance must be isolated from the gas supply piping system by closing its equipment shutoff valve during any pressure testing of the gas supply system at test pressure equal to or less than 1/2 psi (3.5kPa).

The appliance area must be kept clear and free from combustible materials, gasoline and other flammable vapors and liquids.

Do not use this appliance if any part has been under water. Immediately call a qualified service technician to inspect the appliance and to replace any part of the control system and any gas control which has been under water.

**Children and adults should be alerted to the hazards of high surface temperatures and kept at a safe distance to avoid burns or clothing ignition.**

**Young children should be carefully supervised when they are anywhere near the appliance.**

**Clothing or other flammable material should not be hung from the appliance, or placed on or near the appliance.**

**Any screen or guard removed for servicing an appliance must be replaced prior to operating the appliance.**

**Installation and repair should be done by a qualified service person. The appliance should be inspected before use and at least annually by a professional service person. More frequent cleaning may be required as necessary. It is imperative that the control compartments, burners and circulating air passageways of the appliance be kept clean.**

Do NOT burn solid fuels in this gas fireplace.

Do NOT ignite the burner before pouring all of the burner media (lava rock or fire glass) into the burner pan. The media must be evenly distributed over the burner.

**CAUTION:** The propane gas pressure regulator provided with this appliance must be used. This regulator is set for an outlet pressure of 11 inches water column.

This outdoor gas appliance is not intended to be installed in or on recreational vehicles and/or boats.

Before each use of this gas appliance, open the LP (Liquid Propane) Tank Drawer and inspect the LP Hose. If there is evidence of excessive abrasion or wear, or the hose is cut, it must be replaced prior to the gas appliance being put into operation. Use only the replacement hose assembly specified in this manual. Inspect the burner before each use of the appliance. The burner must be replaced prior to the appliance being put into operation if it is evident that the burner is damaged. Use only the burner listed in these instructions.

Keep the fuel supply hose away from any heated surfaces.

# IMPORTANT SAFETY INFORMATION ABOUT PROPANE (LP) GAS

A self contained LP-gas cylinder for use with this appliance must have a capacity of 20 lbs. and must be equipped with a Type 1 connector and an OPD (overfill protection device). See Figure 1.

The LP-gas supply cylinder to be used must be constructed and marked in accordance with the specification for LP-gas cylinders of the U.S. Department of Transportation (DOT) or the National Standard of Canada, *CAN/CSA-B339, Cylinder, Sphere and Tubes for the Transportation of Dangerous Goods.*

- The cylinder supply system must be arranged for vapor withdrawal.
- The cylinder used must include a collar to protect the cylinder valve.
- This appliance shall be used only outdoors in a well-ventilated space and shall not be used in a building, garage or any other enclosed space.
- When this appliance is not in use, the gas must be turned off at the supply cylinder.
- Storage of this appliance indoors is permissible only if the cylinder is disconnected and removed from the appliance.
- Cylinders must be stored outdoors in a well-ventilated area out of the reach of children. Disconnected cylinders must have threaded valve plugs tightly installed and must not be stored in a building, garage or any other enclosed areas.

CSA (Canadian Standards Association) certified to ANSI Z21.97•CSA 2.41-2015 “ Outdoor Decorative Gas Appliances” The gas hose is routed through a “U” bolt to prevent the hose from coming in contact with the burner. DO NOT remove the hose from the “U” bolt. See Figure 2.

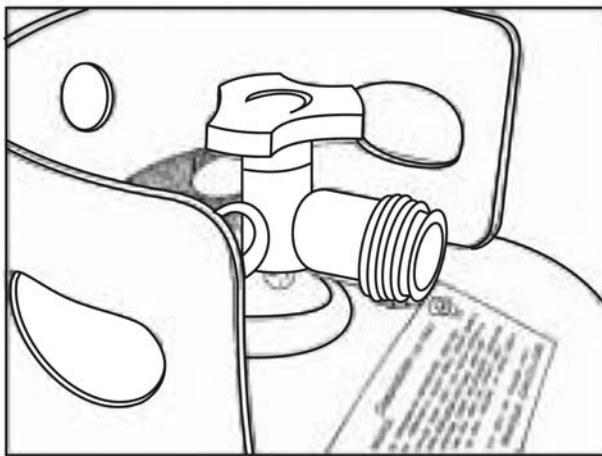

**Figure 1**

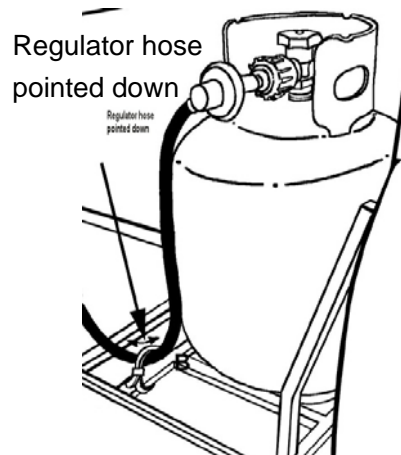















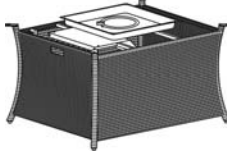



**Figure 2**

## SPECIFICATIONS

INPUT	40,000 Btu/hr	30,000 Btu/hr Low fire
Propane Regulator Pressure	11 inches water column	
Natural Gas Minimum Inlet Pressure	7 inches water column	
Clearances to combustible surfaces	Sides 24in./61cm	Top: 72 in. / 183 cm

# PARTS IDENTIFICATION LIST

	PART	DESCRIPTION	PART#	QTY
A		CONTROL KNOB	FP0245	1
B		GAS VALVE	FP0307	1
C		THERMOCOUPLE	FP0004	1
D		LP REGULATOR HOSE	FP1369	1
E		ELECTRODE	FP1375	1
F		GAS TUBE	FP0309	1
G		ORIFICE ELBOW	FP1385	1
H		IGNITION MODULE	FP0006	1
I		ORIFICE BRACKET	FP0311	1
J		PROPANE ORIFICE	FP1283	1
K		NATURAL GAS ORIFICE	FP1284	1
L		LP TANK RETAINING KNOB	FP0585	2
M		"AAA" BATTERY(1.5V)	HW0705	1
N		ADJUSTABLE FOOT CAPS	FC0553	4
O		BOLTS	HW0036	4
P		WASHERS	HW0103	4
Q		HEX BOLT DRIVER	HW0006	1
R		FIREPIT BASE	FP1532	1
T		FIREPAN/BURNER ASSEMBLY	FP1533	1
V		FIRE ICE SET	ZCF0092	1

# INSTALLATION

1. With the help of another person, turn the table base assembly in the upright position. Carefully place the table top (not included) onto the table base. After making any necessary adjustments to the alignment of the table top and firepit base, use bolts and washers as shown in Figure 3. Guide the bolts through the holes in the base brackets, into the pre-drilled holes in the table top. Do not tighten completely. Repeat on other three sides. (Note: holes do not go through to the top of the table. Holes shown for illustration purposes only.)

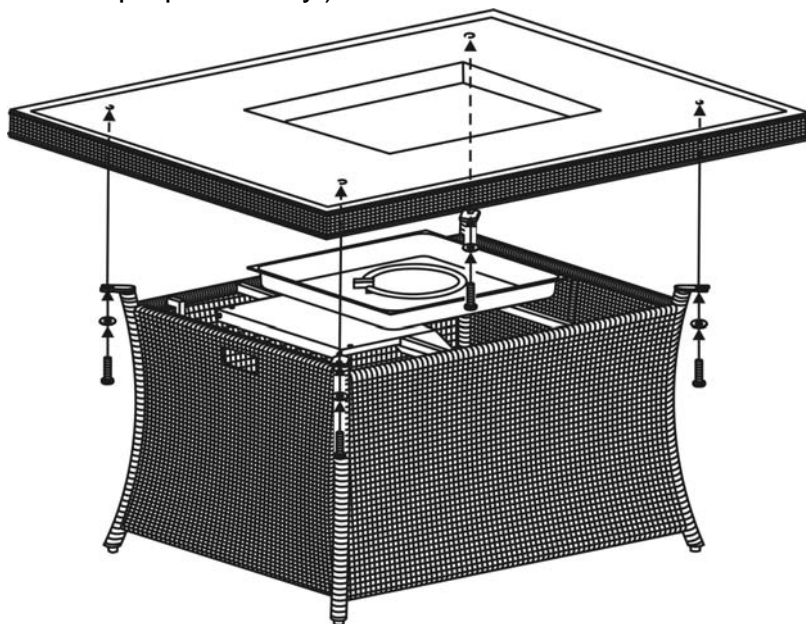

Figure 3

2. Pour all of the fire ices into the burner pan. Completely cover the burner tube with fire ices as shown in Figure 4.

Burner Pan

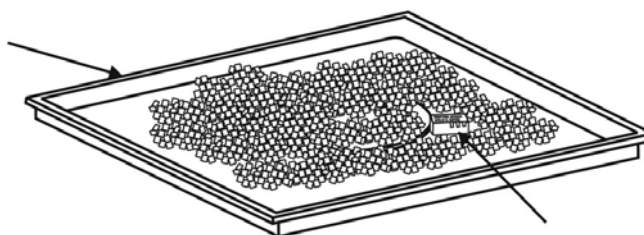
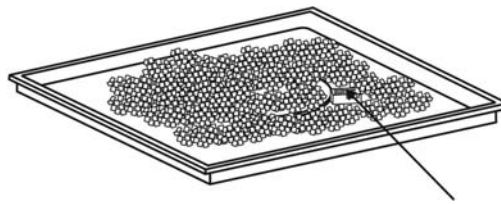

Figure 4

Ignition Well

3. Remove the cardboard cover from the ignition well as shown in Figure 5. Remove any lava rock or fire ice on top of ignition well.



**Figure 5**

**Cardboard Cover**

4. Lift off the tank door, place the tank in the holder and use the chain to hold the tank. Connect the regulator as shown in Figure 6. Turn the black handle clock-wise to tighten. Turn the handle counterclock-wise to remove. The hose must point down. Open the control door and check that the valve is turned all the way clockwise to the “OFF” position. Open the tank valve. Apply a solution of soapy water to the tank-regulator connection and to the valve-hose connection to check for leaks. If soap bubbles continue to form, the connection has a leak. If a leak is found, close the tank valve and tighten all connections. **NEVER USE A FLAME TO CHECK FOR LEAKS.**

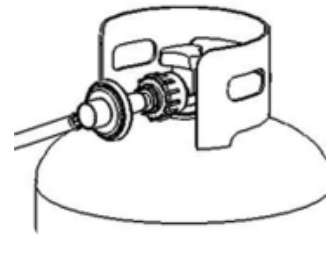
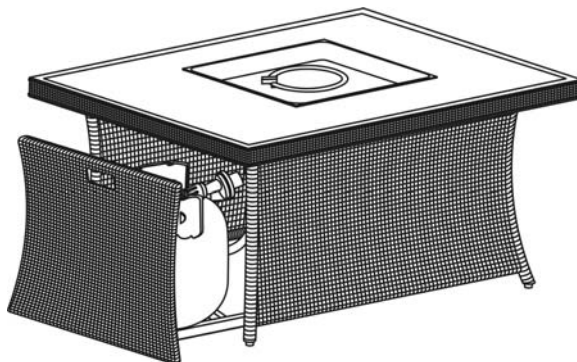

**Figure 6**

5. Tighten threaded knobs found on tank tray (Figure 7) so that the LP tank cannot move from side to side. Do not remove plastic cap from end of threaded section.

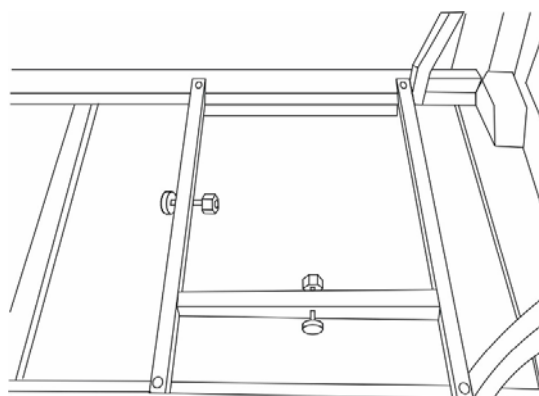

**Figure 7**





# NATURAL GAS CONVERSION



Natural gas conversion must be performed only by your natural gas provider or service company.

1. Disconnect the regulator hose from the gas valve. See Figure 8.

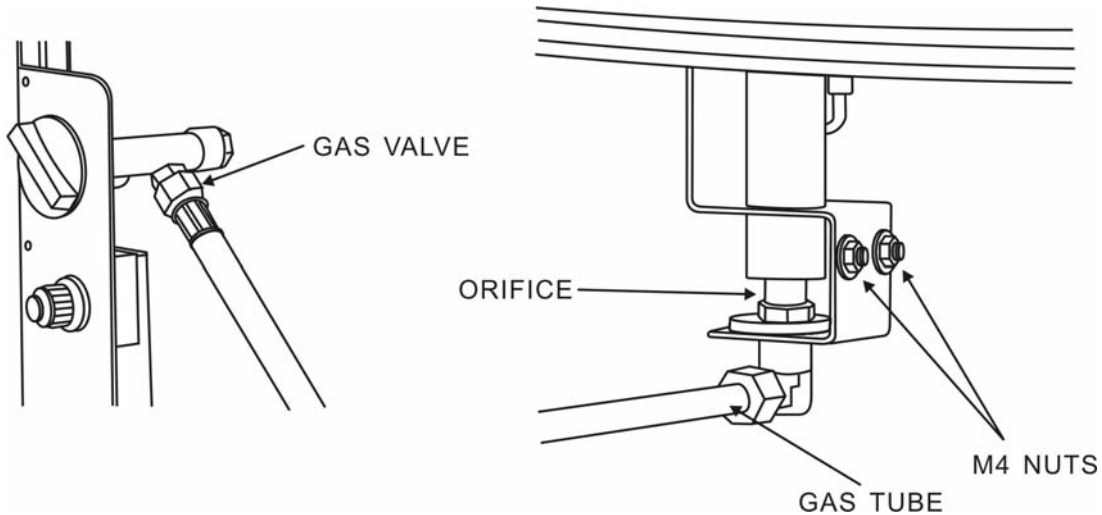

**Figure 8**

2. Disconnect the gas tube from the orifice elbow. Remove the two M4 nuts and remove the orifice holder. Replace the propane orifice with the natural gas orifice from the kit and reinstall the orifice holder. Apply a solution of soapy water to all connections to check for leaks. If soap bubbles continue to form, the connection has a leak. If a leak is found, close the main valve and tighten all connections. **NEVER USE A FLAME TO CHECK FOR LEAKS.**

3. Stick the conversion label on the rating plate as shown in Figure 9.

## Metal Rating Plate

Serial Number _____	Model Number: 98910
<b>CAUTION:</b> The gas pressure regulator provided with this appliance must be used. This regulator is set for an outlet pressure of	
This appliance has been converted to use Natural Gas. Input 40,000 Btu/hr. Max Gas Supply Pressure 7 inch w.c. (1.74 kPa) Min. Gas Supply Pressure 5 inch w.c. (1.24 kPa)	
Minimum clearance from combustible constructions: Sides: 24 in. 609 mm. Top 72 in. 1828 mm.	
<b>FOR OUTDOOR USE ONLY.</b> If stored indoors, detach and leave cylinder outdoors.	
<b>⚠ WARNING:</b> Improper installation, adjustment alteration, service or maintenance can cause injury or property damage. Refer to the owner's information manual provided with this appliance. For assistance, or additional information, consult a qualified installer, service agency, or the gas supplier.	

**Figure 9**

**Conversion Label**

# LIGHTING INSTRUCTIONS

1. Locate the control and igniter panel. Make sure the control knob is in the "OFF" position. See Figure 10. Open the tank door and open the tank valve all the way.
2. Push in the igniter button. You will hear a slight clicking sound. With the igniter button pushed in, push and turn the control knob to the "ON" position. The fire should light within a few seconds. Once the flame is lit, release the igniter button and continue to hold the control knob in for 10 to 15 seconds. Release the control knob. The control knob should pop back out and the fire should remain lit. Note: If the fire does not light, turn the knob to the "OFF" position and wait five (5) minutes before trying again.
3. To turn down the flame, push the control knob in slightly and turn to the Medium (medium flame) or Low (small flame).
4. To shut down the fire pit, turn the control knob to the "OFF" position and turn off the tank valve

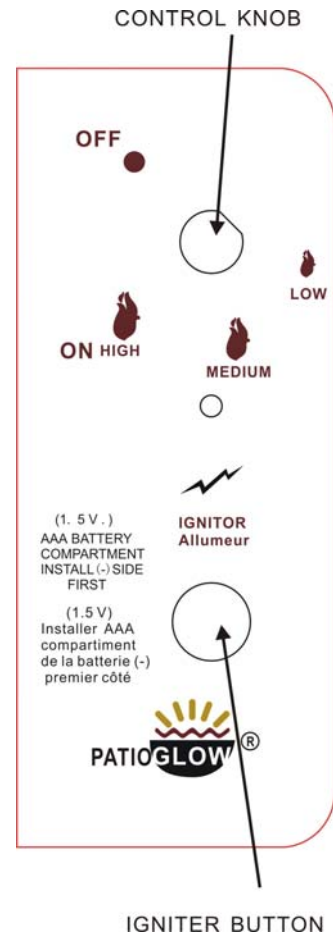

Figure 10

# MAINTENANCE

The flames should look like those in Figure 11. To clean the burner, use a soft brush after the burner and lava rocks have cooled completely. Never use a vacuum cleaner on the lava rocks. It is recommended that the lava rocks be stored indoors during the winter if they will be subjected to freezing temperatures. The propane cylinder must be disconnected and removed from the appliance before the appliance can be stored indoors.



Figure 11

# BATTERIES

Make sure the control knob is in the "OFF" position. Unscrew the push button cap on the ignition module located on the control panel to access the battery compartment. The ignition module requires one AAA size battery. See Figure 12.

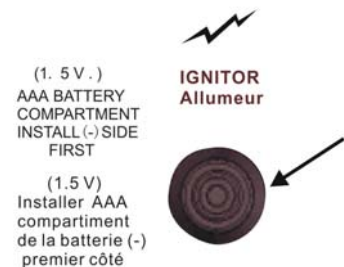
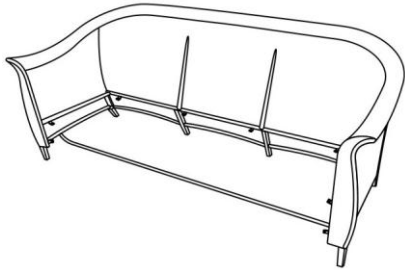
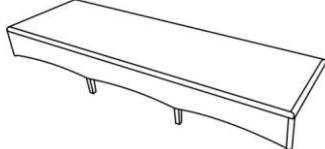
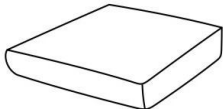
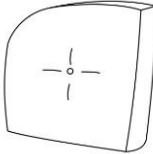
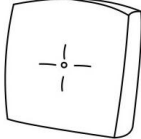

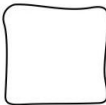
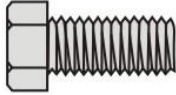



Figure 12

## TROUBLESHOOTING GUIDE

PROBLEM	CAUSE	REMEDY
Burner won't light	No Propane Gas at Burner	Check that gas tank valve is open. Turn control knob to "ON" and push control knob in. Make sure tank has propane gas.
	No Spark at Electrode	Check that AAA battery is installed with negative (-) end first and has a charge. Check that the wire is connected to the ignition module. Check that the electrode is not cracked or broken.
	Lack of oxygen	Remove excess lava rocks or fire ices from around the ignition well.
Burner won't stay lit after lighting	Thermocouple not in flame	Check that the tip of the thermocouple is even with the top of the ignition well. Remove any fire ices from the igtion well.
	Thermocouple connection at the main control valve is loose	Tighten the thermocouple nut at the back of the valve.
	No Fire ice on Burner	Cover the burner with fire ices per the instructions

## PARTS LIST

PART#	DESCRIPTION	PICTURE	Q'TY
A	Chair Frame		1
B	Seat		1
C	Seat Cushion		3
D1	Back Cushion (Left)		1
D2	Back Cushion (Middle)		1
D3	Back Cushion (Right)		1
E	Toss Pillow		2
F	Bolt M6x20		8
G	Washer M6		8

H	Bolt Cover M6		8
I	Open Wrench		1

**Assembly Steps:**

Step 1:

Part# A x 1

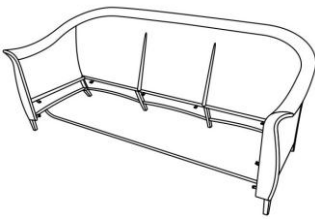

Part# B x 1

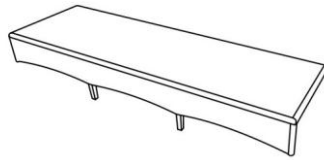

Part# F x 8

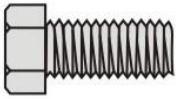

Part# G x 8



Part# H x 8

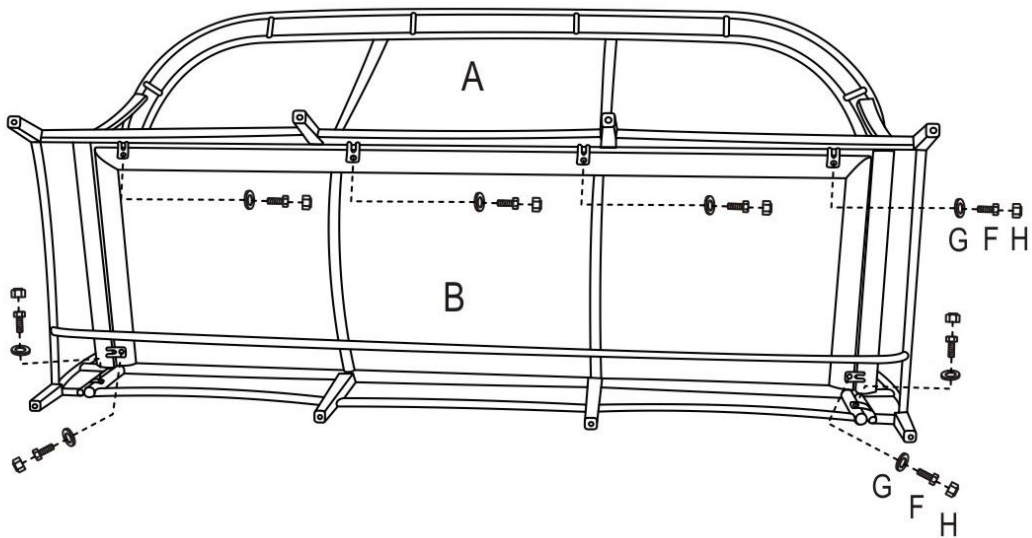

Step 2:

Part# C x 3

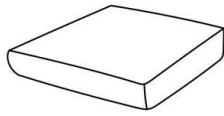

Part# D1 x 1

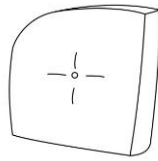

Part# D2 x 1

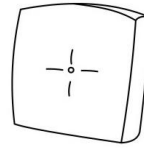

Part# D3 x 1

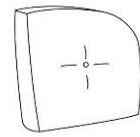

Part# E x 2

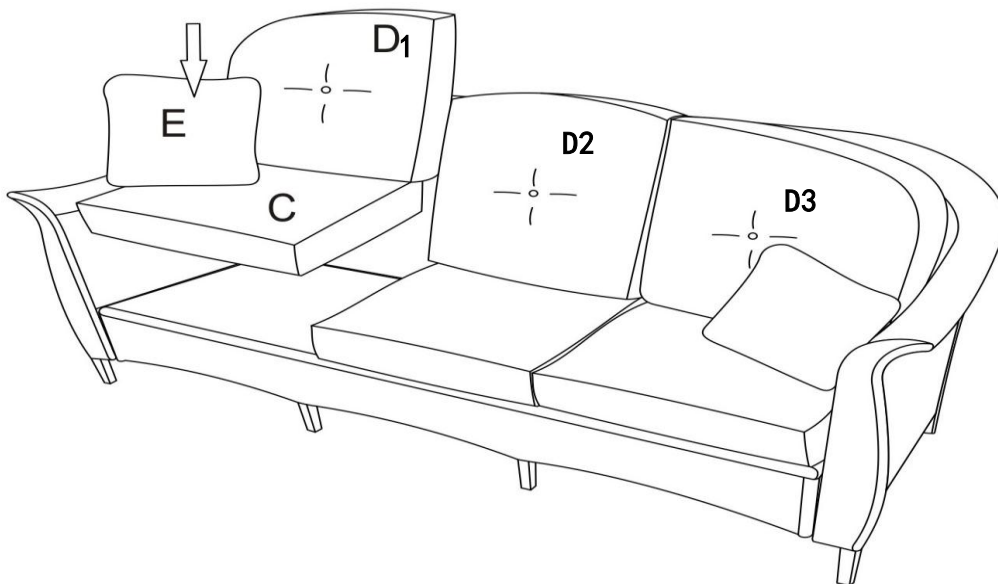
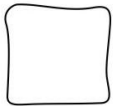

# ONE-YEAR LIMITED WARRANTY

## What is Covered Under This Warranty?

The item you have purchased is warranted against defects in material and workmanship for the following parts from the date of purchase for the period of warranty as outlined below, but only when the unit is installed and operated in accordance with the instructions in this Owner's Manual and in compliance with local building and fire codes:

### **Limited 1 Year**

- Stainless Tube/Plate burner

### **Limited 90 days**

- All remaining parts

## How Do I Obtain Warranty Service?

To obtain warranty service, you must contact our customer service center within the relevant warranty period and provide us with a copy of your dated register receipt as proof of the purchase date. We reserve the right to request photographs and/or return of the defective item(s) and/or such other evidence relating to any claim as we shall reasonably require. Please call our customer service center at 1-800-416-3511 for additional warranty claim details and procedures.

## What are the Limitations and Exclusions of this Warranty?

### Warranty Limitations:

This warranty is subject to the limitation set forth above. In addition, this warranty is made to the original purchaser only and is effective only if items are purchased from one of our authorized dealers. This warranty is not transferable. For warranty replacements based on warranty claims, we will not be responsible for charges associated with shipments outside continental North America at any time or for any reason.

Warranty Exclusions: This warranty is subject to the exclusions set forth above. In addition, the following are excluded from coverage under this warranty: any item used for commercial, contract or any other non-residential purpose; clearance items, display models or items purchased "as is"; freight damage; items subject to misuse, abuse, neglect or lack of proper care or maintenance (including without limitation as provided in any "care and maintenance guide" or similar information we provide); normal wear and tear; damage caused by acts of nature, acts of force majeure, vandalism, fire or other casualty, or improper assembly; hardware against corrosion or rusting; purchased or replacement parts; and all plastic parts. Also excluded are loss of use or time; inconvenience; money; travel; packaging; or incidental, special or consequential damages of any kind. Replacement of defective items or parts as provided herein, or (at our sole discretion) pro rated refund of your purchase price, shall constitute your sole and exclusive remedy for items which are not as warranted. In no event shall our responsibility exceed the purchase price of the item found to be other than as warranted. This warranty is the exclusive statement of your rights with respect to items you have purchased and supersedes any other express warranty or statement, written or oral, made in connection with the purchase and sale of such items. The term "item" when used herein in the singular refers to the specific piece found to be defective, and not to the entire set of which the item is a part.

Some states do not allow exclusion or limitation of incidental or consequential damage, so that limitation may not apply to you. This warranty gives you specific legal rights, and you may also have other rights that vary from state to state.