

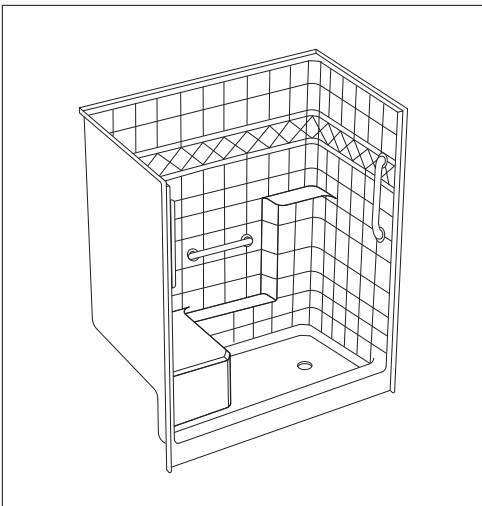

# ELLA'S MILLENNIAL SERIES

*New Construction One-Piece Showers*



## Specification Manual

**60" x 36" x 77"**

Low Threshold Shower Stall & Kit

*Classic Package with Stainless Steel Grab Bars*

For more product information visit [ellasbubbles.com](http://ellasbubbles.com)  
or call Ella's Bubbles toll free at 1-800-480-6850

## Ella's Millennial Series

60" x 36" x 77" New Construction One-Piece Shower  
Classic Package with Stainless Steel Grab Bars



### HANDED BY SEAT



Right Side Seat Shown



Shipping Container



Fiberglass Reinforced Walls

### Representing Model Numbers

- ESM6036SHLWHT-PKG1
- ESM6036SHLBON-PKG1
- ESM6036SHLBIS-PKG1
- ESM6036SHRWHT-PKG1
- ESM6036SHRBON-PKG1
- ESM6036SHRBIS-PKG1

### Technical Information

Material: Gelcoat Fiberglass  
Overall Dimensions: 60 in. x 36 in. x 77 in.  
Net Weight: 175 lbs.  
Drain Location: Left or Right  
Threshold Height: 4 in.  
Shipping Dimensions: 67 in. x 43 in. x 84 in.  
Shipping Weight: 315 lbs.

### Shower Stall and Package Options

#### Available Colors

*\* Color tiles intended for reference only.*

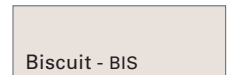
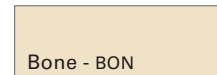
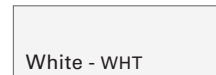

#### Available Packages

Standard, Standard-SA, Classic, Classic-SA, Ultimate, Ultimate-SA, Ultimate-W, Ultimate-WSA, Imperial, Imperial-SA, Imperial-SAFS

### Warranty

- Ella's Millennial Shower Stall: Three (3) Year Limited Warranty  
*\* For more information please visit [ellabubbles.com](http://ellabubbles.com)*

### Codes

This unit shall meet UPC, CSA B45.5, IAPMOZ124-11, Home Innovation Research Lab, and shall meet the requirements of the Southern Building Code.



**MANUFACTURED AND ASSEMBLED IN  
THE UNITED STATES OF AMERICA**

## Ella's Millennial Series

60" x 36" x 77" New Construction One-Piece Shower  
Classic Package with Stainless Steel Grab Bars

---



### PACKAGE ACCESSORIES

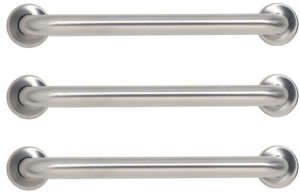

18" Straight Stainless Steel  
Grab Bars (3)



Chrome Strainer Brass Drain  
with Friction Seal – 2 in.

# Ella's Millennial Series

60" x 36" x 77" New Construction One-Piece Shower  
 Classic Package with Stainless Steel Grab Bars



## SPECIFICATION DRAWINGS

Due to the nature of the materials, dimensions may vary  $\pm \frac{1}{2}$  in.

FRONT VIEW

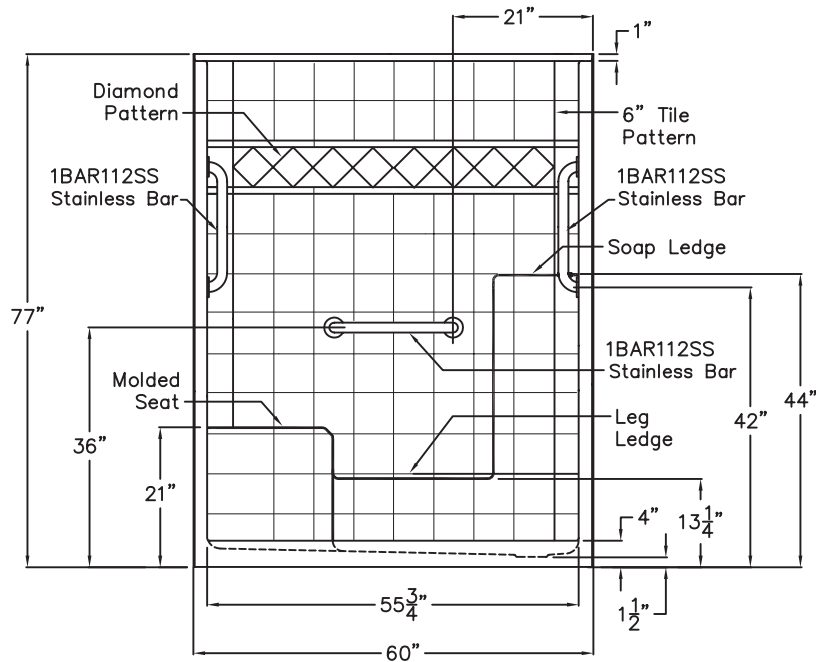

SIDE VIEW

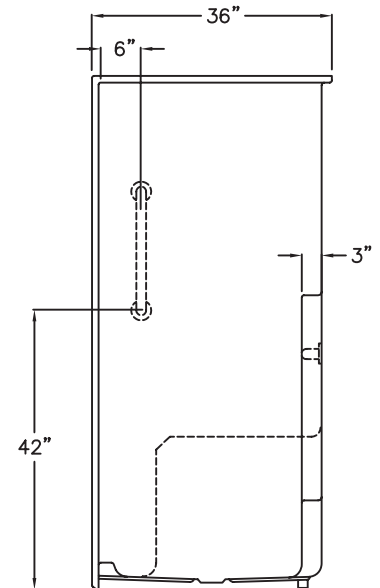

TOP VIEW

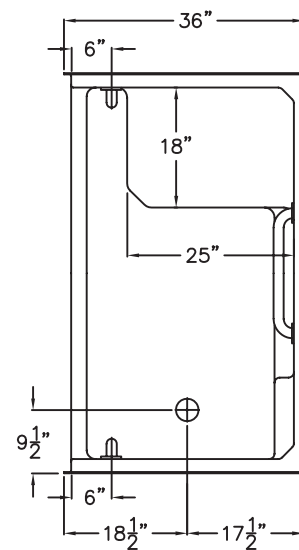

4" LOW THRESHOLD

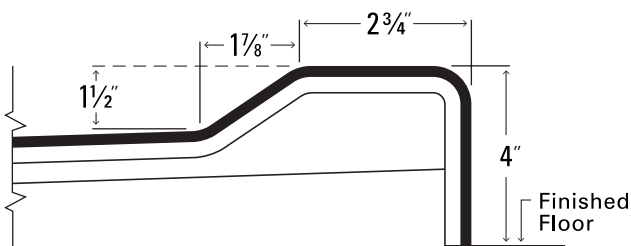

# Ella's Millennial Series

60" x 36" x 77" New Construction One-Piece Shower  
Classic Package with Stainless Steel Grab Bars



## BOARD PLACEMENT DRAWING

Due to the nature of the materials, dimensions may vary  $\pm 1/2$  in.

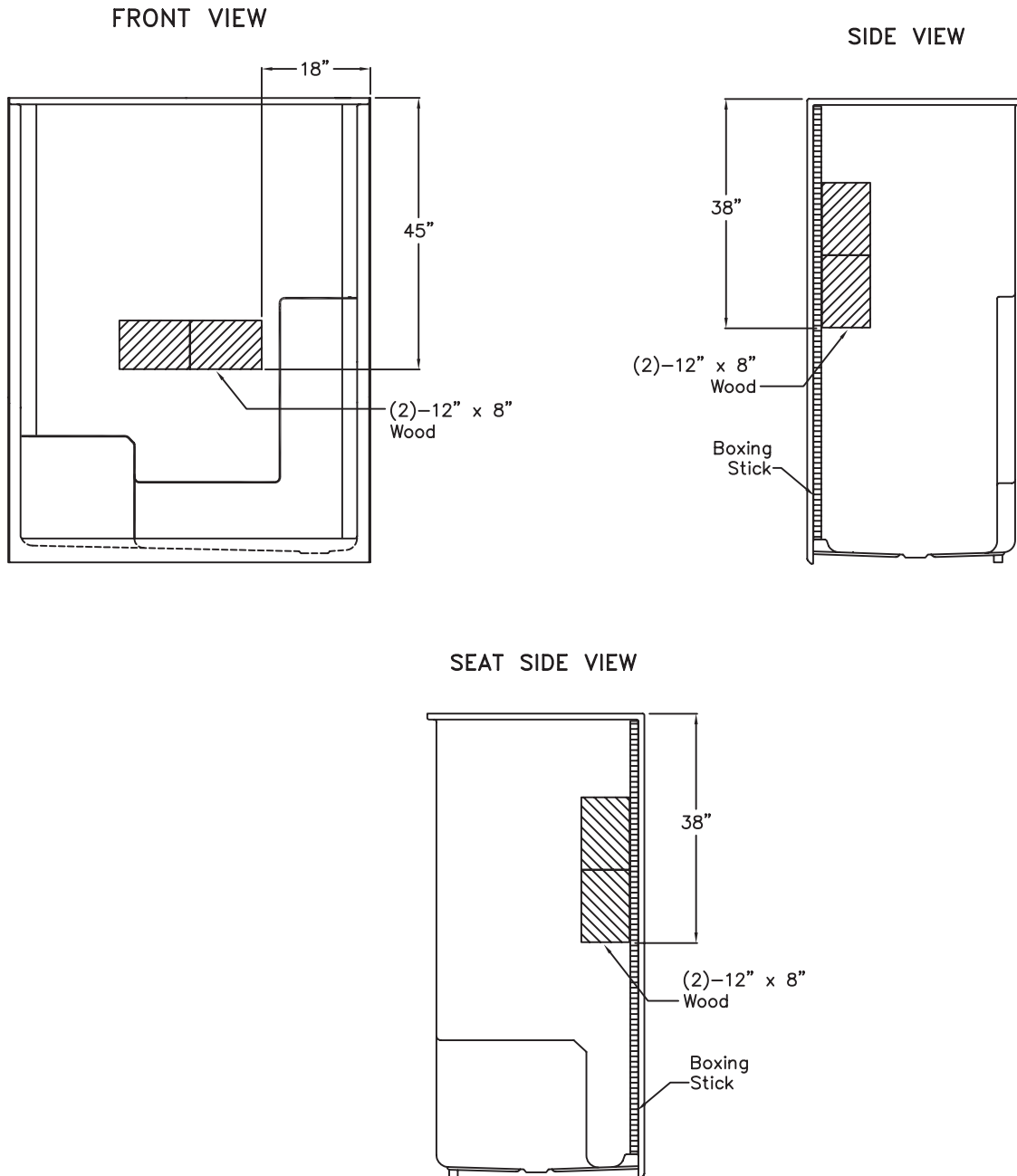

## Ella's Millennial Series

60" x 36" x 77" New Construction One-Piece Shower  
Classic Package with Stainless Steel Grab Bars

**ella**  
by ella's bubbles

### PRODUCT FEATURES

#### Luxurious & Safe Design

- Architectural subway design tile pattern with diamond accent pattern for a traditionally modern aesthetic
- Integrated Grip Sure™ floor texture for safe mobility
- Molded soap, shampoo & foot ledges for added convenience



#### Strength & Durability

- Premium marine-grade, gelcoat & fiberglass polyester resin for a beautiful, long-lasting shower surface
- Reinforced 3/8" wood paneled walls provides flexibility for installing grab bars at any needed height
- Twice the weight and the raw materials used in the production of our showers than listed by any of our competitors



#### Shower Door Friendly

- Ella's Millennial Series showers are fabricated to allow the options of using a curtain or shower door
- At the base, square corners above the low threshold support framed or frameless shower door installation



#### Availability

- Ella's Millennial Series showers are manufactured, inspected & shipped directly from the factory within 5-7 business days
- Rush orders are available upon request (white only)
- No order is too big or too small



#### Contractor Friendly

- Ella's Millennial Series One-Piece showers are preassembled at the factory and require no hardware installation on jobsite
- Compact and durable packaging for easy handling on the jobsite
- Shipped in heavy duty crating to protect the product in transit

