

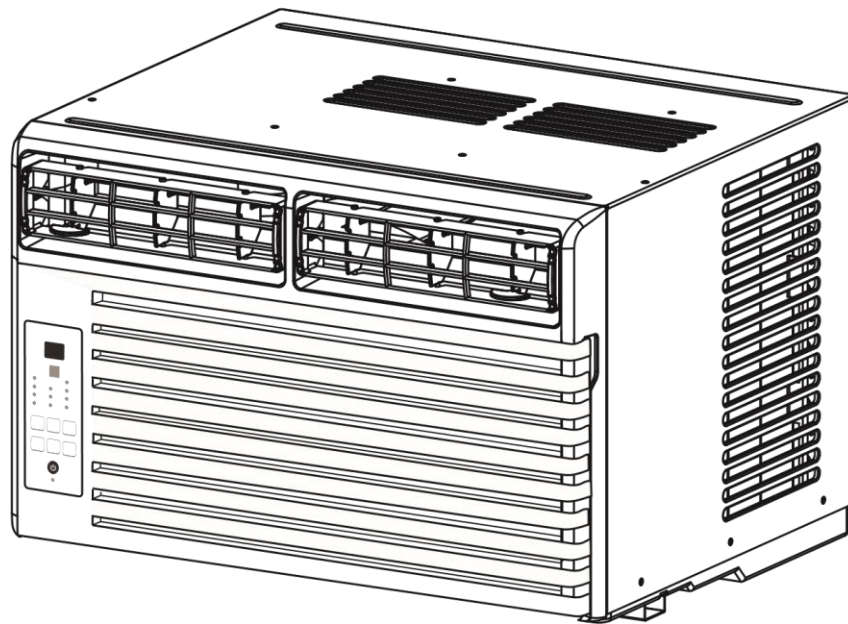

## Models

WS2-06E-201	6,200 BTU
WS2-08E-201	8,000 BTU
WS2-10E-201	10,200 BTU
WS2-12E-201	12,000 BTU

## Electronic Window Air Conditioner Operating Instructions



V180305



## PURCHASE INFORMATION

Thank you for choosing a Soleus Air Air Conditioner. This owner's manual will provide you with valuable information necessary for the proper care and maintenance of your new product. Please take a few moments to thoroughly read the instructions and familiarize yourself with all the operational aspects of your new air conditioner.

For your own records, please attach a copy of your sales receipt to this manual. Also, write the store name/location, date purchased, and serial number below:

Store Name: \_\_\_\_\_

Location: \_\_\_\_\_

Date Purchased: \_\_\_\_\_

Serial Number (located on back of unit): \_\_\_\_\_

## SAFETY INSTRUCTIONS

**Before installing and using your air conditioner, please read this owner's manual carefully. Store this manual in a safe place for future reference. Your safety and the safety of others is very important to us. Please pay attention to all safety messages outlined in this owner's manual.**

**WARNING: To reduce the risk of fire, electrical shock or injury when using your air conditioner, follow the following basic precautions:**

- Plug into a grounded 3 prong outlet.
- Do not remove the ground prong.
- Do not use a plug adapter.
- Do not use an extension cord.
- Unplug the air conditioner before servicing
- Use two or more people to move and install the air conditioner



This is a safety alert symbol.

This symbol alerts you to potential hazards that can harm you or others or even cause death.

All safety messages will directly follow the safety alert symbol and/or the words "DANGER" or "WARNING".

All Safety messages alert you of potential hazards, how to reduce the chance of injury, and what can happen if instructions are not followed correctly.

**⚠ DANGER**

**⚠ WARNING**

Failure to immediately follow these instructions may cause serious injury or even death.



## POWER CORD AND PLUG

This air conditioner is equipped with an LCDI (Leakage Current Detection and Interruption) power cord and plug as required by US National Electric Code 440.65. This cord consists of a length of shielded flexible cord with no termination on the load side and a LCDI attachment plug on the line side.

The LCDI power cord and plug will remove the supply source via electrical disconnect (circuit trip) if the nominal current leakage between the cord shield and either load conductor exceeds a predetermined value. The cord will remain de-energized until the device has been manually reset. This is intended to reduce the risk of a fire in the power cord or combustible materials nearby. The cord shields are not grounded and they must be considered a shock hazards if exposed. The cord shield must not be connected to ground or to any exposed metal.

The test and reset buttons on the LCDI Plug are used to check if the plug is functioning properly. To test:

1. Plug power cord into wall outlet. The LED light will turn on.
2. Press TEST Button, circuit should trip, cutting power to the air conditioner. When this occurs, the LED light will turn off.
3. Press RESET button to restore power to the machine. Once power is restored, the LED light will turn on again.

If test button is pressed and unit can still be turned on, current leakage has been detected. Do not use the air conditioner or attempt to reset the LCDI Plug. Contact Soleus Air Customer Service for troubleshooting recommendations.

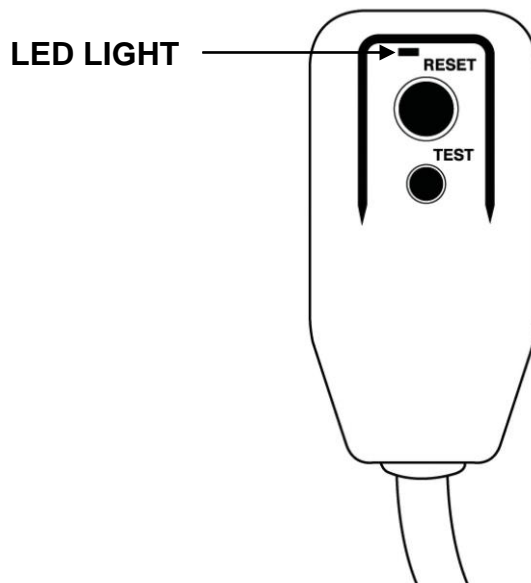

**Note: Your units' power cord and plug may differ from the one shown.**

### WARNING:

1. DO NOT press the TEST button while the air conditioner is operating.
2. The TEST and RESET buttons should not be used as "ON" and "OFF" switches.
3. The cord and plug are not intended to offer protection to externally connected loads or supply circuits.
4. The cord and plug are intended for indoor use only.



# PACKAGE CONTENTS

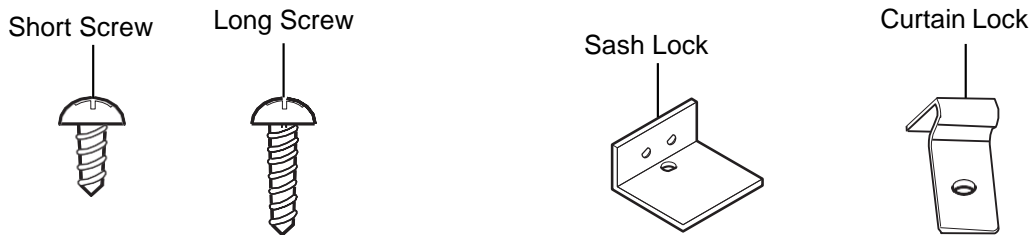
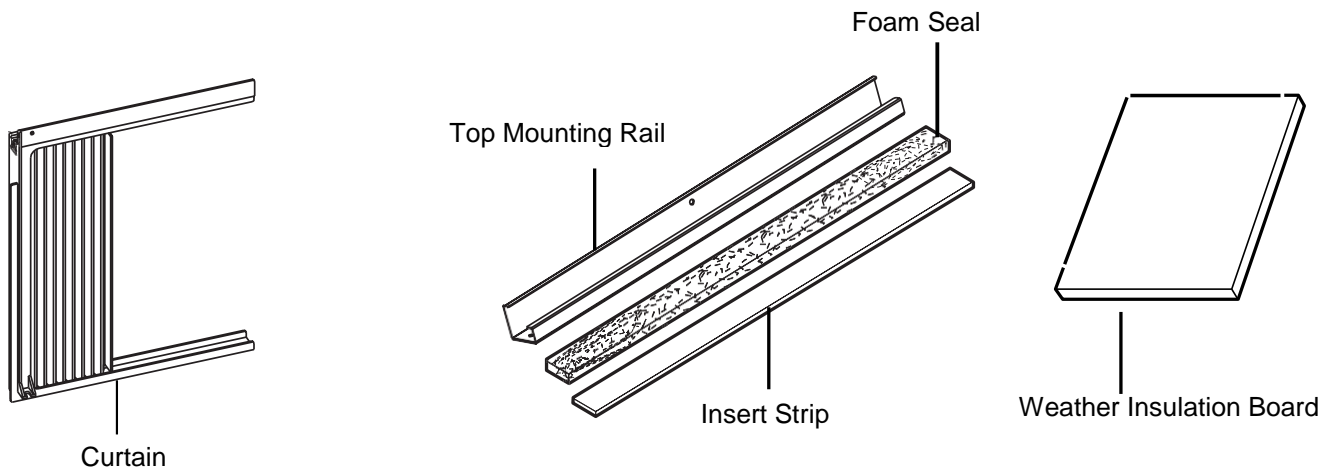
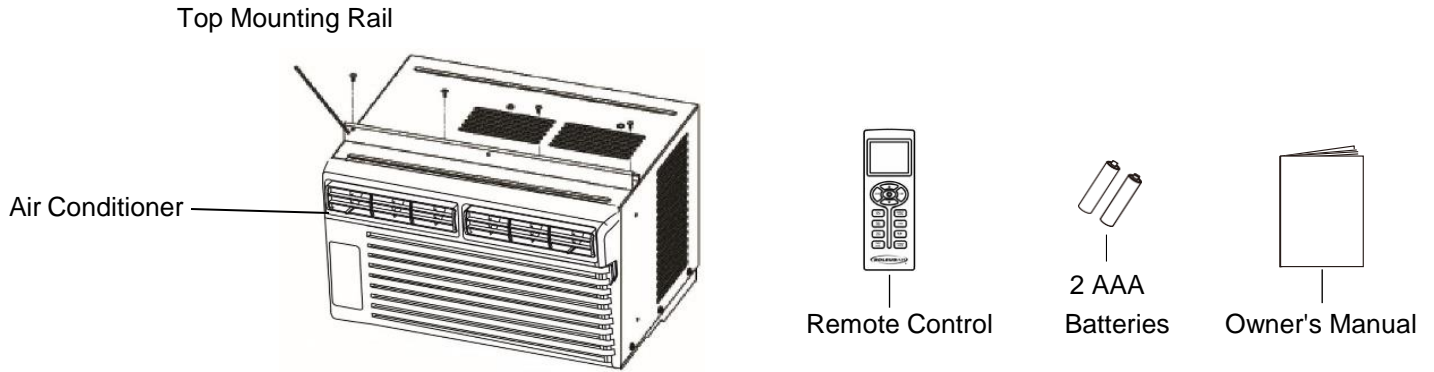

## **Part List:**

- Window Air Conditioner (1)
- Remote Control (1)
- AAA Batteries (2)
- Top Mounting Rail (1)
- Insert Strip (1)
- Short Screw (8)
- Curtain (2)
- Sash Lock (2)
- Foam Seal (1)
- Long Screw for Window Locking Bracket & Curtains (12)
- Curtain Lock (2)
- Owner's Manual (1)
- Weather Insulation Board (2)



## SPECIFICATIONS

- Noise level is measured at a distance of 3.28 ft away from the front of the unit in cooling mode.
- Power consumption is measured when the fan runs at the highest speed setting.
- These specifications are for reference only. For actual data, please refer to the rating label on the back of the unit.

Model	WS2-06E-201	WS2-08E-201
Power Supply (Ph/V/Hz)	1/115/60	1/115/60
Rated Cooling Capacity (BTU/h)	6,200	8,000
Cooling Power Input (Watts)	495	667
Rated Current Cooling (Amperage)	4.3	6.5
CEER	12.1	12
Noise Level dB(A) (L/H)	55/58	58/61
Airflow (H/L) CFM	194/158	264/223
Dehumidifying Capacity	30.48 Pints per day	34.8 Pints per day
Product Dimensions (W" x H" x D")	18.625 x 12.625 x 15.5	19 x 14.375 x 19.5
Package Dimensions (W" x H" x D")	23 x 15 x 18.625	22.5 x 17 x 21.5
Net/Gross Weight (Lbs)	46.3/55.1	57.3/63.9
Refrigerant Type	R-410A	R-410A
Plug Type	NEMA 5-15P	NEMA 5-15P

Model	WS2-10E-201	WS2-12E-201
Power Supply (Ph/V/Hz)	1/115/60	1/115/60
Rated Cooling Capacity (BTU/h)	10,200	12,000
Cooling Power Input (Watts)	850	1,000
Rated Current Cooling (Amperage)	7.5	8.7
CEER	12	12
Noise Level dB(A) (L/H)	55/59	55/59
Airflow (H/L) CFM	264/223	264/155
Dehumidifying Capacity	43.4 Pints per day	52.3 Pints per day
Product Dimensions (W" x H" x D")	19 x 14.375 x 21.5	19 x 14.375 x 21.5
Package Dimensions (W" x H" x D")	21.3 x 17.1 x 22.7	21.3 x 17.1 x 22.7
Net/Gross Weight (Lbs)	66/72	72.7/77.2
Refrigerant Type	R-410A	R-410A
Plug Type	NEMA 5-15P	NEMA 5-15P



**WARNING:** Avoid fire hazard or electronic shock,  
DO NOT use an extension cord or an adapter plug.  
DO NOT remove any prong from the power cord.

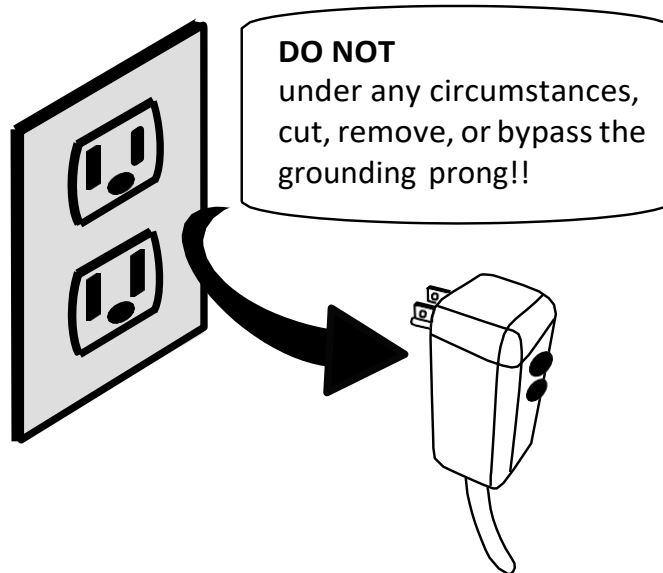

**Power supply cord with 3-prong grounding  
plug and current detection device**

### DISCLAIMER

ALL INFORMATION AND THE TECHNICAL SPECIFICATIONS PRESENTED IN THIS USER'S MANUAL ARE THE PRESENTATION OF THE MANUFACTURER. SOLEUS N.A HAS NOT CONDUCTED INDEPENDENT TEST TO THE INFORMATION AND THE SPECIFICATIONS PRESENTED HEREWITHIN.



# INSTALLATION

## Window Preparation

Please read all instructions prior to installing your air conditioner. Two people are recommended to install this product. If a new electrical outlet is required, have the outlet installed by a qualified electrician before installing the unit.

Before installing the unit, check the dimensions of your window to make sure the air conditioner will fit. This unit is made to fit inside a standard double-hung window. Make sure the window is in good shape and able to firmly hold the needed screws. If not, make repairs prior to installing the unit.

Model	WS2-06E-201	WS2-08E-201/WS2-10E-201/WS2-12E-201
Unit Height	12 5/8"	14 3/8"
Unit Width	18 5/8"	19"
Min. Window Opening(See FIG 1)	13 1/4"	14 3/4"
Min. Window Width	22 1/4"	22 1/2"
Max Window Width	38"	36 7/8"

## Storm Window Requirements

A storm window frame will not allow the air conditioner to tilt properly which in turn will keep it from draining properly. To adjust for this, attach a board or piece of wood to the sill. The board or wood piece should have a depth of at least 1 1/2". Make sure the board or piece of wood is approximately 1/2" higher than the storm window frame. This will allow the air conditioner to tilt enough for proper drainage. (See FIG. 2).

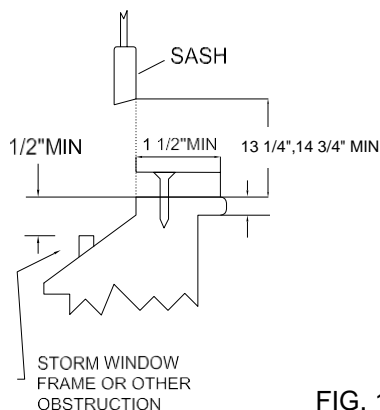

FIG. 1

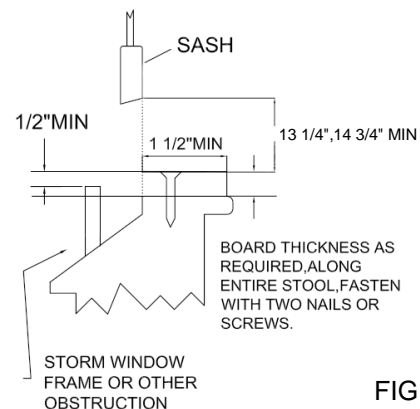

FIG. 2

## Prior to Installing the Air Conditioner

1. Check for anything that could block airflow. Check the area outside of the window for things such as shrubs, trees, or awnings. Check the inside area to make sure curtains, drapes, or blinds will not prevent proper airflow.
2. Check the available electrical outlet. The power supply must be the same as shown on the unit serial nameplate (located on the left side of the unit, near the front faceplate). Be sure the outlet is close enough for the power cord to reach.
3. Carefully unpack the air conditioner. Remove all packing material and make sure the floor is protected when removing. Due to the large size of this air conditioner, two people should move the unit together.

## CAUTION

When handling the unit, be careful to avoid cuts from the sharp metal edges and aluminum fins on the front and rear coils.



## TOP RAIL INSTALLATION

NOTE: Top Rail and the side Panels are offset to provide the proper pitch to the rear of (5/16"). This is necessary for proper condensation utilization and drainage. If you are not using the side panels, the rear pitch must still be maintained.

1. Attach the top rail onto the top of the outer case using four Short Screws.

Top Mounting Rail

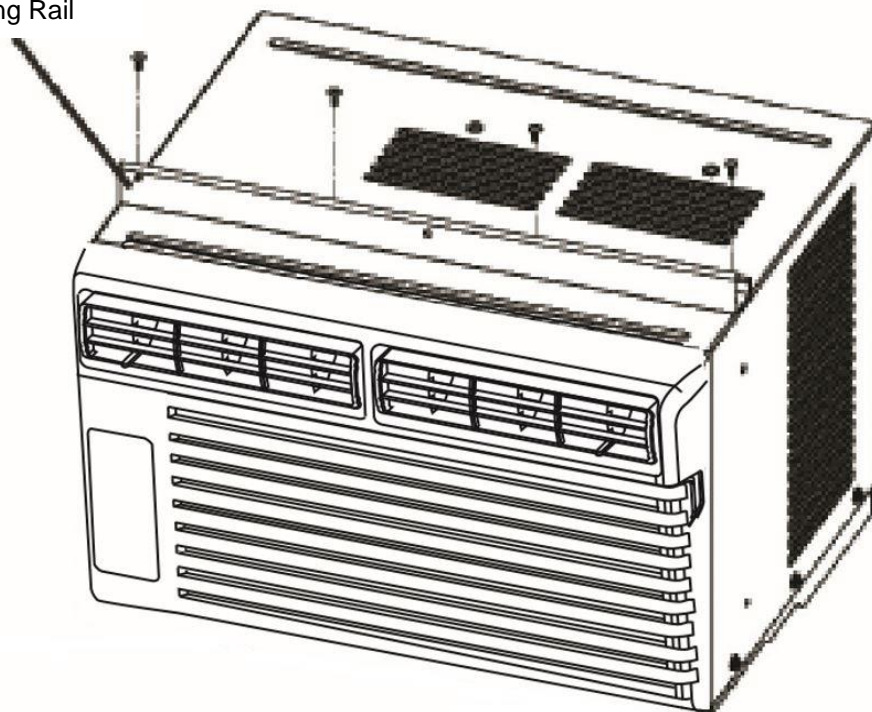



## Curtain & Weather Insulation Board Installation

**NOTE:** The Weather Insulation Board adds an extra layer of insulation to keep air from passing through the sides of the window air conditioner.

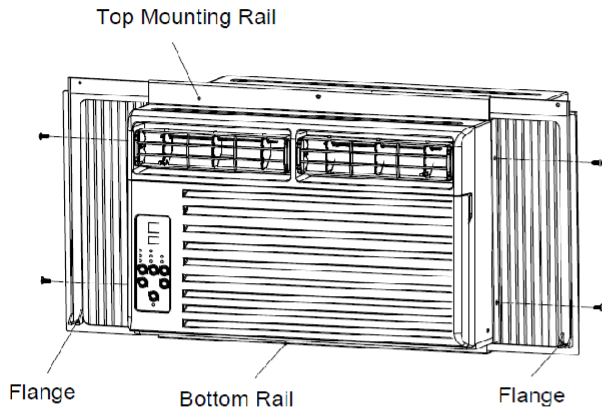

1. Insert the side curtains into the upper and lower rails of the air conditioner. Fasten the curtains to the unit with short screws as shown above.
2. Slide the free end of the curtain into the side panel of the air conditioner. Do this for each side. The flange for securing the curtain into the window sill will be facing the room side when installed.
3. Using a sharp blade or scissors, slowly cut the Weather Insulation Board to a size that will fit the inside curtain rails and completely cover the curtain.
4. Once properly sized, remove the backing to expose the adhesive tape.
5. Place the Weather Insulation Board over the left curtain and firmly press and hold for 5 seconds.
6. Repeat above steps to install the Weather Insulation Board on right curtain.

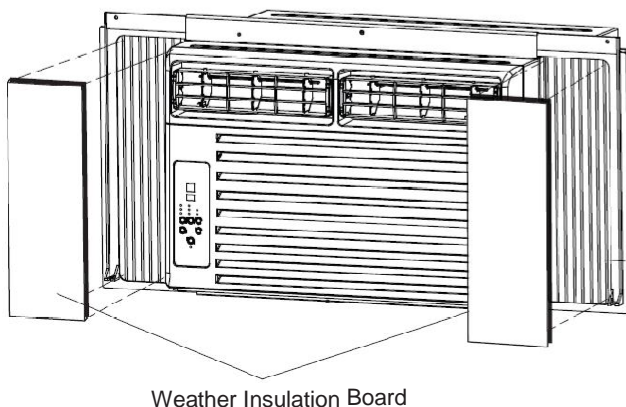

## Placing the Unit Inside a Normal Window

1. Set the unit in the window so that is centered. Place the unit so that front edge of the bottom rail is against the back edge of the sill.
2. Bring the window down so that the front edge of the top rail is in front of the window. Be sure the unit is tilting slightly to the outside.

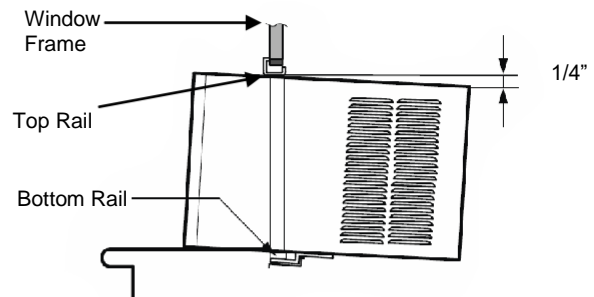

3. Once the air conditioner is placed, extend the left and right curtains to the width of the window.
4. Place the curtain lock between the curtain extensions and the window sill, drive long screws through the lock and into the sill as shown below:

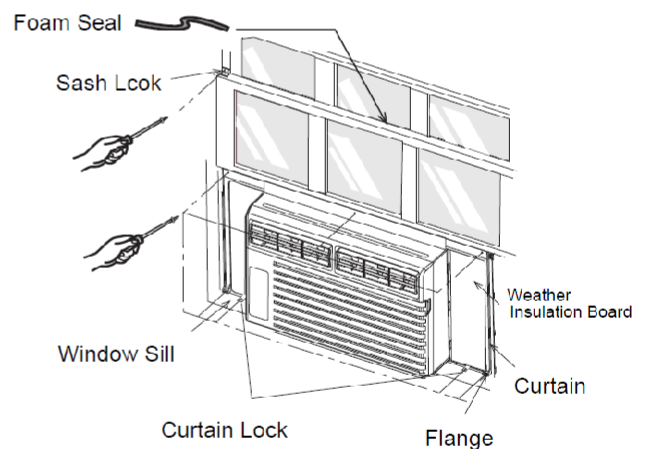

5. Secure the left and right flanges on end bottom side of the curtain with long screws.
6. Drive long screws through upper frame holes into window sash.
7. Attach the sash lock to the place between the upper and lower sashes and secure it with long screws. Each side uses 2 long screws.
8. Cut the foam seal to the window width and insert the sash seal between the glass and the window to prevent air and insect from getting into the room.
9. For added insulation, the insert strip can be inserted between the air conditioner and window sill. This is optional.

## INSTALLATION

### IF AC is Blocked by a Storm Window

A storm window frame will not allow the air conditioner to tilt properly which in turn will keep it from draining properly. To adjust for this, attach a board or piece of wood to the sill. The board or wood piece should have a depth of at least 1 1/2". Make sure the board or piece of wood is approximately 1/2" higher than the storm window frame. This will allow the air conditioner to tilt enough for proper drainage. (See FIG. 4).

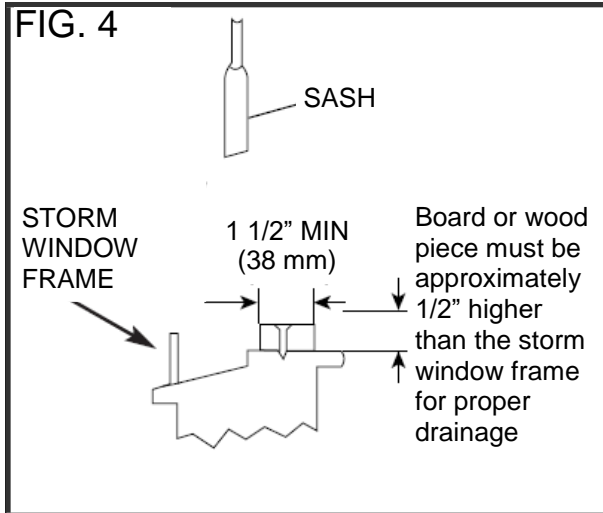

#### Note:

1. All supporting parts must be secured to firmed wood, masonry, or metal
2. The air conditioner can be installed without the curtains to fit in a narrow window opening.
3. The electric outlet must be within reach of the power cord.

### Removing the Air Conditioner from the Window

1. Turn the air conditioner off and disconnect the power cord.
2. Remove the sash seal from between windows and unscrew sash lock.
3. Remove the screws installed through the frame and frame lock.
4. Close (slide) the side panels into frame.
5. Keeping a firm grip on air conditioner, raise the sash and carefully "rock" air conditioner backward to drain any condensate water in base of unit. Be careful not to spill any remaining water while lifting unit from window.
6. Store parts with the air conditioner in the box.

# CONTROL PANEL LAYOUT

## Electronic Control Panel & Remote Control

Note: This control panel display always shows the room temperature in Fan Mode except when setting the temperature and timer.

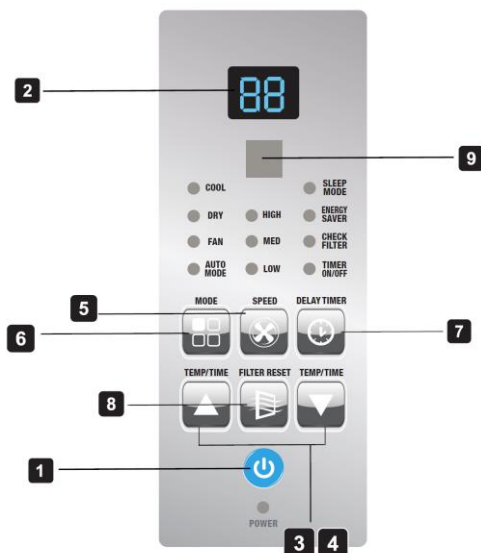

### Normal Operating Sounds

- You may hear a pinging noise caused by water hitting the condenser on rainy days, or when the humidity is high. This design feature helps remove moisture and improve efficiency.
- You may hear the thermostat click when the compressor cycles on and off.
- Water will collect in the base pan during rain or days of high humidity. The water may overflow and drip from the outside part of the unit.
- The fan may run even when the compressor is not on.

1. **Power Button:** Turn the air conditioner on and off.
2. **Digital Display:** Will display set temperature when the unit is in Cool, Dry, Auto, Sleep, Energy Saver mode, and display current room temperature when in Fan mode.
3. **Temperature Set:** Use these buttons on the control panel or remote to increase or decrease the Set Temperature.

4. **Timer Set:** Use these buttons on the control panel and remote control to set the timer. Each press of the ▲ or ▼ button will increase or decrease the timer. For timer instructions see #7.
5. **Fan Speed:** Use the fan speed button to change the fan speed. Choose between high, medium, and low.
6. **Mode Button:** Press the MODE button to cycle through the various modes: Cool, Dry, Fan, Auto, Sleep, Energy Saver
7. **Auto-on Timer:** When the air conditioner is off, it can be set to automatically turn on in 1-24 hours at the previous set mode and fan settings. To set the Auto-on Timer, press the DELAY TIMER button on the unit or remote control. Timer can be set in 1 hour increment.

**Auto-off Timer:** When the air conditioner is on, it can be set to automatically turn off in 1-24 hours. To set the Auto-off Timer, press the DELAY TIMER button on the unit or remote control. Timer can be set in 1 hour increment.

Once timer is set, TIMER ON/OFF indicator on control panel will light up, the set temperature will also, shown on digital display.

- To see the remaining time, press DELAY TIMER button. To change the timer settings, use the ▲ or ▼ on control panel or remote control.
  - During preview of timer setting, press DELAY TIMER button once to display set time, press the button one more time to cancel the settings.
8. **Filter Reset:** After the fan rotates for 250 total hours, the filter check light will turn on to remind the user to clean the filter. Press the FILTER RESET button to reset the reminder once the filter is cleaned.
  9. **Signal Receiver:** Point the remote control to the air conditioner when sending instruction to the unit.





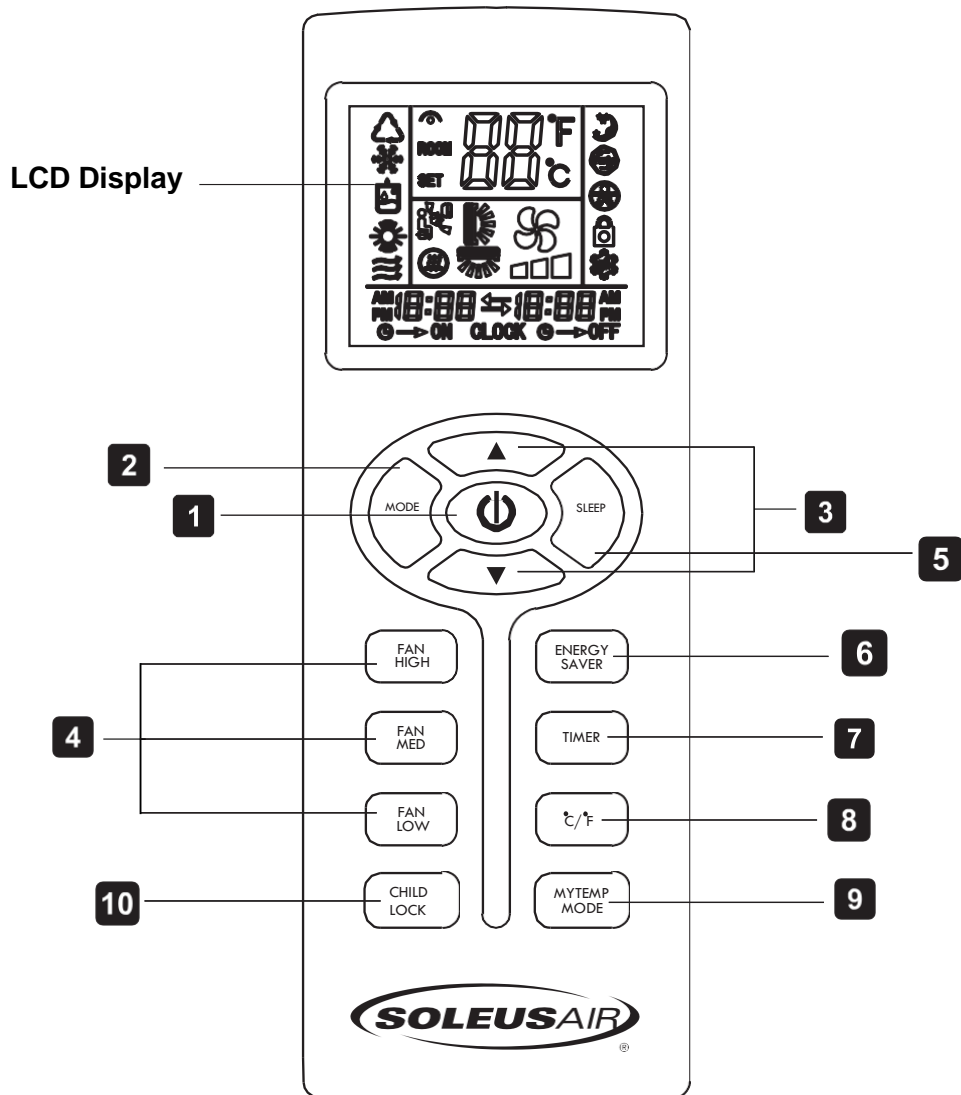

# REMOTE CONTROL



Battery Size: AAA - NOTE: Do not mix old and new batteries or different types of AAA batteries.

## OPERATING INSTRUCTIONS

1. **ON/OFF** - Press the  button to turn the A/C on or off. When the unit is turned off, the Timer function will be cancelled. The set temperature will be saved.
2. **MODE SELECTION** - Press the MODE button repeatedly to cycle between the different modes: Auto, Cool, Dry (Dehumidifier), and Fan.
3. **TEMPERATURE SETTING** - Press the  button to decrease the temperature when the unit is on. Stop pressing the button when the desired temperature is displayed. Temperature range is 61°F-90°F. Press the  button to increase the temperature when the unit is on. Stop pressing the button when the desired temperature is displayed. Temperature range is 61°F-90°F.
4. **FAN** - Press the FAN button to turn on the fan mode.  
FAN HIGH –Press this button to set the fan speed to high. Can be used in COOL or FAN mode.  
FAN MED –Press this button to set the fan speed to medium. Can be used in COOL or FAN mode.  
FAN LOW –Press this button to set the fan speed to low. Can be used in COOL or FAN mode.
5. **SLEEP MODE** - Sleep mode can be activated under Cool mode, Dry mode, Auto mode, and Fan mode. Press the SLEEP button on the remote control, When in SLEEP mode, the fan will run on low to keep fan noise at a minimum. The temperature setting will gradually increase to 2°F above the original set temperature for each of first 2 hours. The unit will keep operating the same temperature until the sleep mode is turned off.
6. **ENERGY SAVER** - Press the ENERGY SAVER button to turn on Energy Saver mode. When the unit is in Energy Saver mode, the energy saver light will turn on. Selecting Energy Saver mode will cycle the fan off and on with the compressor to limit energy consumption. Use this feature when the room is unoccupied and a greater range of room temperature is acceptable.
7. **TIMER** - Press the TIMER button when the unit is off to set up the Auto-on timer. The hour indicator on the digital display will start flashing. Press the Timer button to set timer within 1-24 hours.  
Press the TIMER button when the unit is on to set up the Auto-off timer. The hour indicator on the digital display will start flashing. Press Timer button to set timer within 1-24 hours. To cancel the timer, press the TIMER button repeatedly until the timer mode is off.
8. **°C/°F** - Press the  button to switch the temperature between Celsius and Fahrenheit.
9. **MYTEMP MODE** - Press the MYTEMP MODE button to change the thermostat sensor from the air conditioner to the remote location. When Mytemp mode is activated, double hyphen sign "--" will flash 3 seconds on digital display. The air conditioner will cool the area depending on the location and set temperature of the remote control. Take the remote control with you so the air conditioner cools the room to your location.
10. **CHILD LOCK** - Press this button to lock/unlock the remote control buttons.



## USE THE AIR CONDITIONER

- Freezing Conditions:** This is a cooling only air conditioner. It is not designed for freezing outdoor conditions. It must not be used in freezing outdoor conditions.
- Remote Control:** To ensure proper operation when using the remote control, aim the remote directly at the signal receiver on the air conditioner.
  - The remote control has a signal range up to 20 feet.
  - Make sure nothing is blocking the remote control signal from being received by the air conditioner.
  - Make sure the batteries are installed correctly and still have power.
- Cooling Mode:** Use the Cool mode at High, Medium, Low fan speed when cooling is needed. Use the temperature ▲ or ▼ buttons to set the desired temperature between 61°F-90°F.
  - Once the temperature is set, the compressor will cycle on and off to keep the room temperature at the set temperature level. The lower the set thermostat temperature, the cooler the room will be. The higher the set thermostat temperature, the warmer the room will become.
  - For Normal Cooling - set the mode to Cool and the Fan to High or Med with the temperature set in the Middle.
  - For Maximum Cooling - set the mode to Cool and the Fan to High with a lower set temperature.
  - For Quieter & Nighttime Cooling - set the mode to Cool and the Fan to Low with the temperature set in the middle.
- Energy Saver Mode:**
  - When the Energy Saver mode is **ON**, the fan will cycle on and off with the compressor. This results more wider variations of room temperature and humidity. Normally, it is used when the room is occupied. The fan may continue to run for a short time after the compressor cycles off.
  - When the Energy Saver mode is **OFF**, the fan runs all the time in fan or cool mode.
- Fan Only Mode:** Use Fan Only mode at High, Medium, or Low fan speed to provide air circulation and filtering without cooling. Since Fan Only setting does not provide cool, a set temperature cannot be entered. The room temperature will appear in the display.
- Loss of Power Protection:** If power to the air conditioner is lost or interrupted, the air conditioner will automatically restart in the setting last used prior to power loss. Timer will be cancelled when power is lost or interrupted. You may need to set a new timer if desired.
- Air Direction:** Use the lever on the front air vents to adjust the airflow direction. You can direct the airflow to left, right, up or down. The lever is located on the lower left and right side of the air vent.
- Auto Mode:** The air conditioner will automatically choose Cool or Fan mode based on current room temperature.
- Ventilation:** In order to maintain the best cooling condition, pull the Fresh Air Lever to close the vent. When fresh air is necessary, push the Fresh Air Lever to open the vent allowing fresh air being re-circulated in the room.

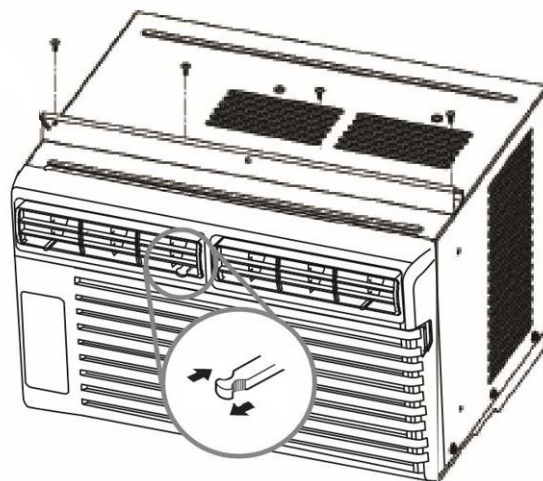

\*Fresh Air Lever is unavailable on WS2-06E-201 model.

## CARE AND CLEANING

Clean your air conditioner to keep it looking new and to minimize dust build up.

### Air Filter Cleaning

The air filter should be checked at least once every month to see if it needs cleaning. Trapped particles and dust can build up in the filter and may decrease airflow as well as cause the cooling coils to accumulate frost. To clean the air filter:

1. Remove the filter by pulling down on the indents of the filter door on the front of the unit. (See FIG. 5)
2. Wash the filter using liquid dish soap and warm water. Rinse the filter thoroughly. Gently shake the filter to remove excess water.
3. Let the filter dry completely before placing it into the air conditioner.
4. If you do not wish to wash the filter, you may vacuum the filter to remove the dust and other particles.

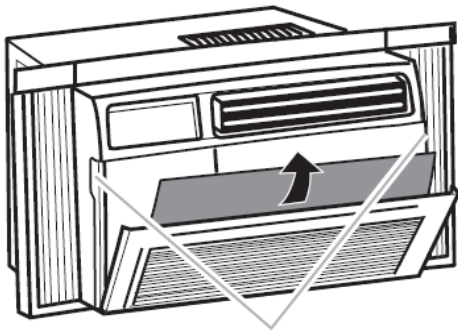

Indents

Fig. 5

### Wear and Tear

To minimize wear and tear on the air conditioner, always wait at least 3 minutes before changing modes. This will help prevent the compressor from overheating and the circuit breaker from tripping.

### Cabinet Cleaning

To clean the air conditioner cabinet:

- Unplug the air conditioner to prevent shock or a fire hazard. The cabinet and front panel of the air conditioner may be dusted with an oil-free cloth or washed with a cloth dampened in a solution of warm water and mild liquid soap. Rinse thoroughly with a damp cloth and wipe dry.
- Never use harsh cleaners, wax or polish on the cabinet front.
- Be sure to wring excess water from the cloth before wiping around the controls. Excess water in or around the controls may cause damage to the air conditioner.

### Winter Storage

To store the air conditioner when it is not in use for an extended period of time, remove it carefully from the window according to the installation instructions and cover it with plastic or place it in the original box.

### Error Codes

Error Codes	Description
E2	Room temperature sensor failure
E3	Room temperature pipe sensor failure

If the Error Codes continue to display after unplugging and re-plugging the power cord, call our customer service at (877) 665-9765 for further solution.



## TROUBLESHOOTING

PROBLEM	POSSIBLE CAUSES	SOLUTIONS
<b>The Air Conditioner will not start</b>	The air conditioner is unplugged	<ul style="list-style-type: none"> <li>Make sure the air conditioner plug is pushed completely into the outlet.</li> </ul>
	The fuse is blown/circuit breaker is tripped.	<ul style="list-style-type: none"> <li>Check the main fuse/circuit breaker box and replace the fuse or reset the breaker.</li> </ul>
	Power Failure	<ul style="list-style-type: none"> <li>The unit will automatically restart when power is restored.</li> <li>There is a protective time delay (approx. 3 minutes) to prevent tripping of the compressor overload. For this reason, the unit may not start normal cooling for 3 minutes after it is turned back on.</li> </ul>
	The current interrupter device is tripped.	<ul style="list-style-type: none"> <li>Press the RESET button located on the power cord plug.</li> <li>If the RESET button will not stay engaged, discontinue use of the air conditioner and contact a qualified service technician.</li> </ul>
<b>The Air Conditioner does not cool as it should</b>	Airflow is restricted	<ul style="list-style-type: none"> <li>Make sure there are no curtains, blinds, or furniture blocking the front of the air conditioner</li> </ul>
	The temperature control may not be set correctly.	<ul style="list-style-type: none"> <li>Lower the set thermostat temperature</li> </ul>
	The air filter is dirty	<ul style="list-style-type: none"> <li>Clean the filter. See the Cleaning and Care Section of the manual.</li> </ul>
	The room may be too warm	<ul style="list-style-type: none"> <li>Please allow time for the room to cool down after turning on the air conditioner.</li> </ul>
	Cold air is escaping	<ul style="list-style-type: none"> <li>Check for open furnace registers and cold air returns</li> </ul>
	The Cooling Coils are frozen	<ul style="list-style-type: none"> <li>See "Air Conditioner Freezing Up" below.</li> </ul>
<b>The Air Conditioner is freezing up</b>	Ice blocks the air flow and stops the air conditioner from cooling the room	<ul style="list-style-type: none"> <li>Set the MODE dial to HIGH FAN or HIGH COOL and set the thermostat to a higher temperature</li> </ul>





## TROUBLESHOOTING

<b>PROBLEM</b>	<b>POSSIBLE CAUSES</b>	<b>SOLUTIONS</b>
<b>Water is dripping outside</b>	Hot and Humid weather.	<ul style="list-style-type: none"><li>• This is normal</li></ul>
<b>Water is dripping inside the room</b>	The air conditioner is not correctly tilted outside.	<ul style="list-style-type: none"><li>• For proper water drainage, make sure the air conditioner is slightly tilted downward from the front of the unit to the rear.</li></ul>
<b>Water collects in the base pan</b>	Moisture removed from the air is draining into the base pan.	<ul style="list-style-type: none"><li>• This is normal for a short period in areas with low humidity and normal for a longer period in areas with high humidity.</li></ul>
<b>The Remote Control is not working</b>	The batteries are inserted incorrectly The batteries may be dead	<ul style="list-style-type: none"><li>• Check the position of the batteries.</li><li>• Replace the batteries</li></ul>



## LIMITED WARRANTY

### **Two Year Components Limited Warranty Five Year Compressor Limited Warranty**

Soleus N.A. warrants the accompanying Soleus Air Air Conditioner to be free of defects in material and workmanship for the applications specified in its operation instruction for a period of TWO (2) years for components and FIVE (5) years for the compressor from the date of original retail purchase in the United States.

If the unit exhibits a defect in normal use, Soleus N.A. will, at its option, either repair or replace it, free of charge within a reasonable time after the unit is returned during the warranty period.

As a condition to any warranty service obligation, the consumer must present this Warranty Certificate along with a copy of the original purchase invoice.

#### **THIS WARRANTY DOES NOT COVER:**

- Damage, accidental or otherwise, to the unit while in the possession of a consumer not caused by a defect in material or workmanship.
  - Damage caused by consumer misuse, tampering, or failure to follow the care and special handling provisions in the instructions.
- Damage to the finish of the case, or other appearance parts caused by wear.
- Damage caused by repairs or alterations of the unit by anyone other than those authorized by Soleus N.A.
- Freight and Insurance cost for the warranty service.
- Filter and Accessories

ALL WARRANTIES, INCLUDING ANY IMPLIED WARRANTY OF MERCHANT ABILITY ARE LIMITED TO ONE-YEAR DURATION OF THIS EXPRESS LIMITED WARRANTY. **SOLEUS N.A.** DISCLAIMS ANY LIABILITY FOR CONSEQUENTIAL OR INCIDENTAL DAMAGES AND IN NO EVENT SHALL SOLEUS N.A.'S LIABILITY EXCEED THE RETAIL VALUE OF THE UNIT FOR BREACH OF ANY WRITTEN OR IMPLIED WARRANTY WITH RESPECT TO THIS UNIT.

This warranty covers only new products purchased from our authorized dealers or retailers. It does not cover used, salvaged, or refurbished products.

As some states do not allow the limitation or exclusion of incidental or consequential damages, or do not allow limitation on implied warranties, the above limitations and exclusions may not apply to you. This warranty gives you specific legal rights, and you may also have other rights that vary from state to state.

#### **For Technical Support and Warranty Service**

Please Call (877) 665-9765

[www.soleusna.com](http://www.soleusna.com)

