

## Alarm Clock Charging Station with 2 USB Charging Ports

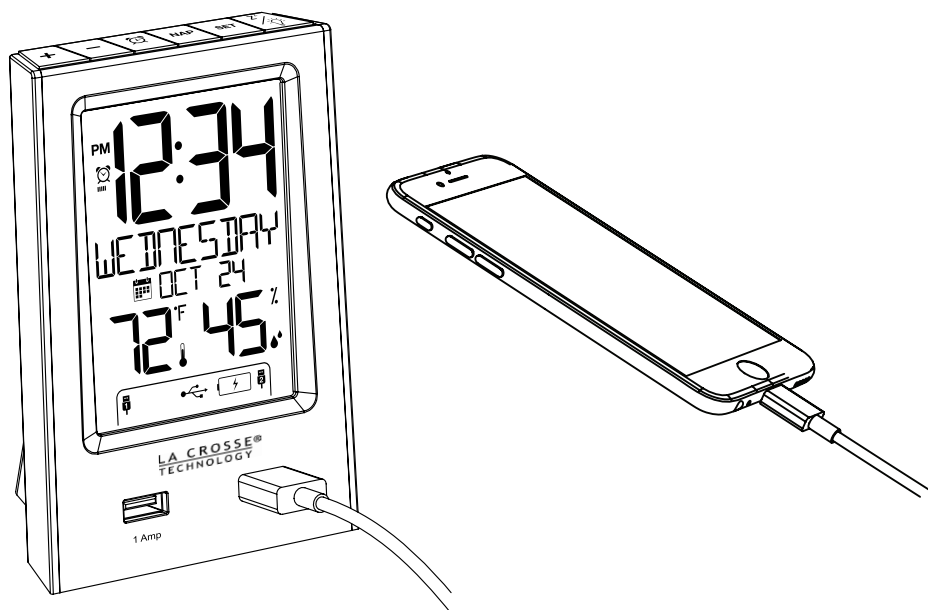

### Table of Contents

Buttons (on top) .....	1
LCD Features .....	1
Setup .....	1
Settings: Language, Time, Date, etc. ....	2
Nap Feature .....	3
Backlight (HI-LOW-OFF).....	4
USB Charge Ports .....	4
Included USB to Micro or Lightning Cable .....	4
Cable Hooks .....	5
Time Alarm .....	5
Alarm Type Indicators .....	6
Activate/Deactivate Alarm .....	6
Snooze .....	6
Low Battery Icon .....	7
Care and Maintenance .....	7
Specifications .....	7
Warranty and Support .....	7

## Buttons (on top)

PLUS

MINUS

ALARM

NAP

SET

SNZ/LIGHT

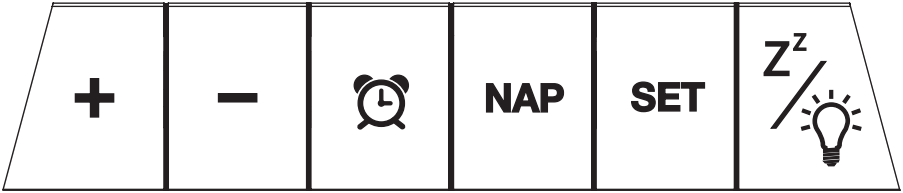

## LCD Features

- 1 Time (manual set)
- 2 Low Battery Icon
- 3 Alarm Icon (M-F)
- 4 Weekday, Nap duration, or Snooze duration
- 5 Month/Date
- 6 Indoor Temperature
- 7 Indoor Humidity
- 8 USB 1 Charge Indicator
- 9 USB 2 Charge Indicator
- 10 USB 1 Charge Port 1 Amp
- 11 USB 2 Charge Port 2 Amp

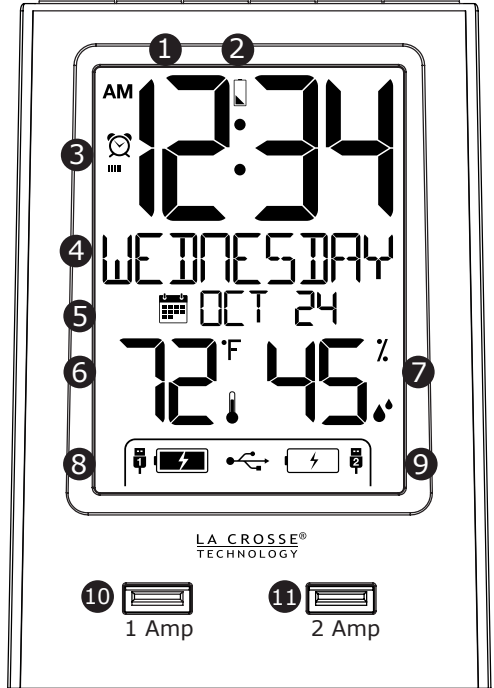

## Setup

1. Insert the 5.0 volt power cable into the outlet, then into the clock.
2. (Optional), Insert 2 AAA batteries (included) into the clock.
3. Set language, time, calendar, temperature unit and snooze duration.

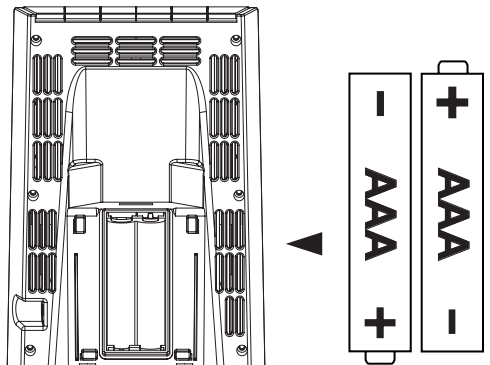

## Settings: Language, Time, Date, etc.

- Hold the **SET** button to enter time set mode.
- Press the **+/-** buttons to adjust the values.
- Press the **SET** button to confirm adjustments and move to the next item.
- Press the **SNZ/LIGHT** button at any time to exit.

### **Time set order:**

1. Language (English or Spanish)
2. Beep ON/OFF
3. Hour
4. Minutes
5. Year
6. Month
7. Date
8. Fahrenheit/Celsius
9. Snooze duration (5 minutes-120 minutes)

**Begin:** Hold the **SET** button for 3 seconds. ENGLISH will show.

### **Language: English or Espanol**



When Español is selected, the instructions on screen will be in Spanish.

### **BEEP ON/OFF**



### **Hour then Minutes**



### **Year then Month then Date**



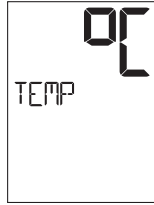
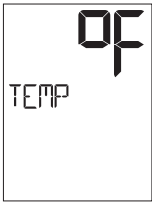

## Nap Feature

Sometimes, we just want a quick nap without having to set a new alarm. Set the nap duration one time, then, a simple press of the **NAP** button starts the nap countdown.

### Set Nap Duration:

1. Hold the **NAP** button for 3 seconds. **NAP** and the duration will show (default is 10 minutes).
2. Use the **+/-** buttons to select a nap duration (up to 120 minutes).
3. Press the **NAP** button to confirm and start nap count down to zero.
4. Press the **SNZ/LIGHT** button at any time to exit.



**Ready for a Nap?** Press the **NAP** button once, and the clock will wake you at the preselected time.

- From normal time display, press the **NAP** button once to start the nap feature for the preset time. **NAP** will show with the preset duration.
- Minutes and seconds will countdown.
- When the alarm sounds **NAP** and **0m** will flash. The alarm will sound for two minutes and then stop if no buttons are pressed.
- Press any button except **SNZ/LIGHT**, at any time to exit nap mode.

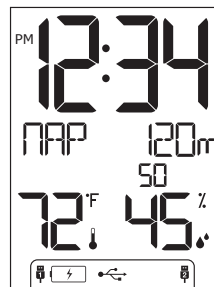
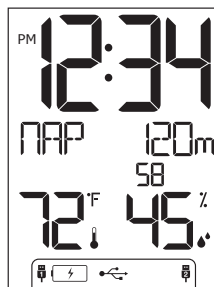

## **Backlight (HI-LOW-OFF)**

- When operating with the power cable, the backlight is adjustable: HI-LOW-OFF.
- Press and release the **SNZ/LIGHT** button to adjust the backlight.
- When operating on batteries only, the backlight will come on briefly when the **SNZ/LIGHT** button is pressed.

## **USB Charge Ports**

### **USB Output:**

- Charge devices that self-regulate.
- Do not charge multiple devices from the same USB port.
- For Tablets and other high power devices, use the USB port on the right (2 Amp).
- Must operate clock with power cable to charge other devices.
- Plug your device into one of the USB ports on the front of the clock.
- The clock will show HELLO for 3 seconds.
- The lightning bolt will flash while charging.
- When no device is connected, no battery will show.
- As your device becomes full and less current is drawn, solid battery icon may show, before the charge is complete.

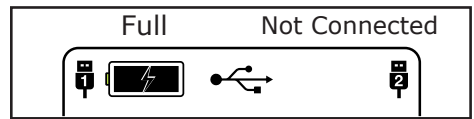
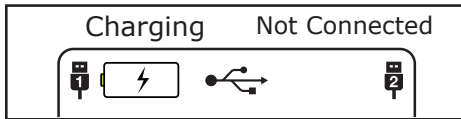
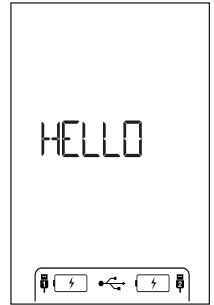

Note: The FULL icon will show when full. After charging, the clock will provide a trickle charge and show the charging icon. Your device may not show fully charged.

## **Included USB to Micro USB or Lightning Cable**

- The included USB cord offers a Micro USB connection or a Lightning connection on the same cord.
- Use your own charge cord or the included cord to charge your device.
- Place your cord in the handy hook on the back of the clock.

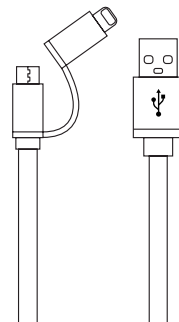

## Cable Hooks

- On the back of the clock there are two cable hooks to secure your charging cables.
- Simply slide your cable into the hook and the end of your cable will be easy to find every time.

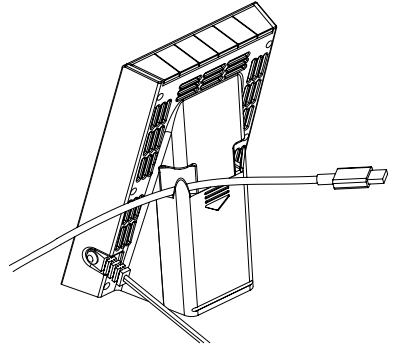
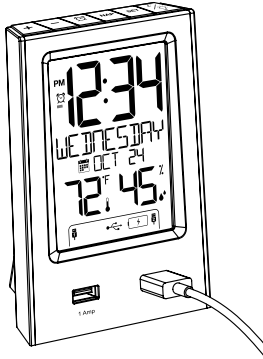

## Time Alarm

- Press and release the **ALARM** button to view alarm time.
- With alarm time showing, hold the **ALARM** button for 3 seconds to enter alarm settings.
- Set the time then select alarm type:  
(Single alarm, Mon-Fri alarm, or Weekend alarm)
- Setting and activating the alarm are separate functions.

### **Alarm Type** (choose the type for each alarm):

- **Daily/Single**-Will alarm at the same time every day when active.
- **Mon-Fri**-Will only alarm Monday through Friday when active.
- **Weekend**- Will only alarm Saturday and Sunday when active.

### **Set Alarm:**

1. Press and release the **ALARM** button to view alarm time.
2. With alarm time showing, hold the **ALARM** button for 3 seconds to enter alarm time set mode.
3. Press the **+/-** buttons to adjust the alarm hour.
4. Press the **ALARM** button to confirm and move to the minutes.
5. Press the **+/-** buttons to adjust the alarm minutes.
6. Press the **ALARM** button to confirm and move to alarm type.
7. Use the **+/-** to select SINGLE, MON-FRI or WEEKEND alarm.
8. Press the **ALARM** button to confirm and exit.

Note: This is a crescendo alarm. It will sound for two minutes then shut off completely if no buttons are pressed.

## Alarm Hour then Minutes

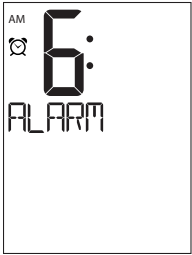

## Alarm Type

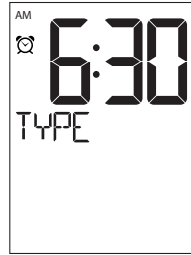

## Daily / Single

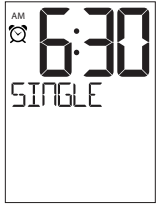

## Mon-Fri



## Weekend



## Alarm Type Indicator

### Alarm Type:

- **Daily/Single:** Clock icon only
- **Mon-Fri:** Clock icon with 5 lines below
- **Weekend:** Clock icon with 2 lines below

### Daily / Single



### Mon-Fri



### Weekend



## Activate/Deactivate Alarm

- When you finish settings, the alarm is active.
- From the normal time display, press and release the **ALARM** button to view alarm.
- Press and release the **ALARM** button to deactivate or to activate the alarm.
- When active the alarm clock icon will show.
- The clock icon will not show if the alarm is not active.



## Snooze

- When the alarm sounds, press the **SNZ/LIGHT** button. The alarm will be silent for the preselected snooze duration.
- SNOOZE - duration will show, and the snooze time will count down.
- When alarm sounds again, the **SNOOZE - 0** will flash.



## **Low Battery Icon**

- The low battery icon will appear between the hour and minutes.
- This icon indicates it is time to replace the batteries.

## **Care and Maintenance**

- Do not mix old and new batteries.
- Do not mix Alkaline, Standard, Lithium, or Rechargeable Batteries.
- Always purchase the correct size and grade of battery most suitable for intended use.
- Replace all batteries of a set at the same time.
- Clean the battery contacts and also those of the device prior to battery installation.
- Ensure the batteries are installed with correct polarity (+ and -).
- Remove batteries from equipment when it is not used for extended period.
- Promptly remove expired batteries.

## **Specifications**

**Temperature Range:** 32 °F to 122°F (0°C to 50°C)

**Humidity Range:** 10%RH to 99%RH

**Power:** 5.0V AC6: HX36-0503500AU

Optional-2-AAA, IEC, LR3 batteries (included)

**USB Output:** 1 Amp and 2 Amp

**Battery Life:** Battery life is over 24 months with reputable batteries

**Dimensions:** 3.74" W x 2.40" D x 5.24" H (95 x 61 x 133 mm)

## **Warranty and Support**

La Crosse Technology, Ltd. provides a 1-year limited time warranty (from date of purchase) on this product relating to manufacturing defects in materials & workmanship.

**Before returning a product, please contact our friendly customer support with questions or visit our online help:**

**Phone:** 1-877-408-2678

**Online Product Support:**

[www.lacrossetechnology.com/support](http://www.lacrossetechnology.com/support)

**Product Registration:**

[www.lacrossetechnology.com/support/register](http://www.lacrossetechnology.com/support/register)

**View full warranty details online at:**

[www.lacrossetechnology.com/warranty\\_info.pdf](http://www.lacrossetechnology.com/warranty_info.pdf)

**Warranty Address:**

La Crosse Technology, Ltd  
2830 S. 26th St.  
La Crosse, WI 54601

