

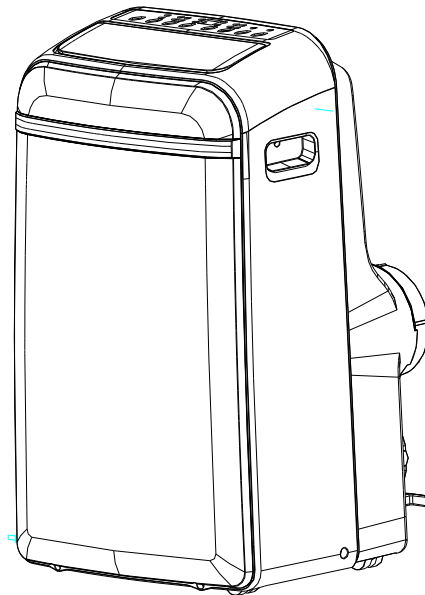

## PORTABLE AIR CONDITIONERS

# OWNER'S MANUAL



**WA-1240E:** 12,000 BTU Cooling only

**WA-1240H:** 12,000 BTU Cooling and Heating

**WA-1420E:** 14,000 BTU Cooling only

**WA-1420H:** 14,000 BTU Cooling and Heating

Inside you will find many helpful hints on how to use and maintain your air conditioner properly. Just a little preventative care on your part can save you a great deal of time and money over the life of your air conditioner. Before operating this product, please read the instructions carefully and save this manual for future use.

# CONTENTS

---

## **SOCIABLE REMARK**

|                      |   |
|----------------------|---|
| Sociable remark..... | 2 |
|----------------------|---|

## **SAFETY PRECAUTIONS**

|                              |   |
|------------------------------|---|
| Safety rules .....           | 3 |
| Operating condition .....    | 3 |
| Electrical information ..... | 4 |

## **IDENTIFICATION OF PARTS**

|                     |   |
|---------------------|---|
| Accessories .....   | 4 |
| Names of parts..... | 5 |

## **AIR CONDITIONER FEATURES**

|   |   |
|---|---|
| Electronic control operating instructions ..... | 6 |
|---|---|

## **OPERATING INSTRUCTIONS**

|                              |   |
|------------------------------|---|
| Operating instructions ..... | 7 |
|------------------------------|---|

## **INSTALLATION INSTRUCTIONS**

|                                   |    |
|-----------------------------------|----|
| Location .....                    | 9  |
| Window kit installation .....     | 9  |
| Exhaust hose installation .....   | 12 |
| Through-the-wall connection ..... | 12 |
| Water drainage .....              | 13 |

## **CARE AND MAINTENANCE**

|                            |    |
|----------------------------|----|
| Care and maintenance ..... | 14 |
|----------------------------|----|

## **TROUBLESHOOTING TIPS**

|                        |    |
|------------------------|----|
| Trouble shooting ..... | 15 |
|------------------------|----|

## **HANDLING THE REMOTE CONTROLLER**

|                                   |    |
|-----------------------------------|----|
| Replacing batteries .....         | 16 |
| Function buttons .....            | 17 |
| Indicators on LCD .....           | 18 |
| Using the remote controller ..... | 19 |

## **YOUR GUARANTEE**

### **NOTE**

The rating data indicated on the energy label is based on the testing condition of installing an un-extended air exhaust duct without adaptor B (please refer to the accessories chart on page 4.)

**DISPOSAL:** Do not dispose this product as unsorted municipal waste. Collection of such waste separately for special treatment is necessary.

It is prohibited to dispose of this appliance in domestic household waste.

For disposal, there are several possibilities:

- A) The municipality has established collection systems, where electronic waste can be disposed of at least free of charge to the user.
- B) The manufacture will take back the old appliance for disposal at least free of charge to the user.
- C) As old products contain valuable resources, they can be sold to scrap metal dealers.

Wild disposal of waste in forests and landscapes endangers your health when hazardous substances leak into the ground-water and find their way into the food chain.

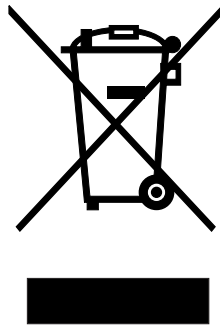

**CAUTION:**

- This appliance is not intended for use by persons (including children) with reduced physical sensory or mental capabilities, or lack of experience and knowledge, unless they are being supervised or been given instruction concerning the use of the appliance by a person responsible for their safety.
- Children should be supervised to ensure that they do not play with the appliance.

## SAFETY PRECAUTIONS

### Safety rules

To prevent injury to the user or other people and property damage, the following instructions must be followed. Incorrect operation due to ignoring of instructions may cause harm or damage.

#### ⚠ Always do this

- Your air conditioner should be used in such a way that it is protected from moisture. e.g. condensation, splashed water, etc. Do not place or store your air conditioner where it can fall or be pulled into water or any other liquid.
- Always transport your air conditioner in a vertical position and stand on a stable, level surface.
- Turn off the product when not in use.
- Always contact a qualified person to carry out repairs. If the power cord is damaged, it must be repaired by a qualified electrician.
- Keep a clearance of at least 12 inches around the unit for proper airflow (from walls, furniture and curtains).
- If the unit is knocked over during use, turn off power immediately and unplug from power source.
- Never leave the unit unsupervised when in operation.
- When unit is not in good order, please use common sense to prevent further damage to surroundings.

#### ⊘ Never do this

- Do not operate your air conditioner in a wet/damp room such as a bathroom or laundry room.
- Do not touch the unit with wet or damp hands or when barefoot.
- Do not press the buttons on the control panel with anything other than your fingers.
- Do not remove any fixed covers. Never use this appliance if it is not working properly, or if it has been dropped or damaged.
- Never use the plug to start and stop the unit.
- Do not cover or obstruct the inlet or outlet grilles.
- Do not use hazardous chemicals to clean or allow to come into contact with the unit.
- Do not use the unit in the presence of flammable substances or vapor such as alcohol, insecticides, petrol, etc.
- Do not allow children to operate the unit unsupervised.
- Do not use this product for functions other than those described in this instruction manual.

#### Energy Save

- Use the unit in the recommended room size.
- Locate the unit where furniture cannot obstruct the air flow.
- Keep blinds/curtains closed during the sunniest part of the day.
- Keep the filters clean.
- Keep doors and windows closed to keep cool air in and warm air out.
- If a very hot day is expected, turn on the unit early to keep the room cool and keep the heat out.

### Operating condition

- The air conditioner must be operated within the temperature range indicated below:

| MODE                       | ROOM TEMPERATURE      |
|----------------------------|-----------------------|
| COOL                       | 62°F~95°F (17°C~35°C) |
| DRY                        | 55°F~95°F (13°C~35°C) |
| HEAT (heating models only) | 41°F~88°F (5°C~30°C)  |

### Suggested tools for window kit installation

1. Screwdriver (medium size Phillips)
2. Tape measure or ruler
3. Knife or scissors
4. Saw (In the event that the window kit needs to be cut down in size because the window is too narrow for direct installation)





## IDENTIFICATION OF PARTS

### **⚠ WARNING For your safety**

- Do not store or use gasoline or other flammable vapors and liquids in the vicinity of this or any other appliance.
- Avoid fire hazard or electric shock. Do not use an extension cord or an adaptor plug. Do not remove any prong from the power cord.

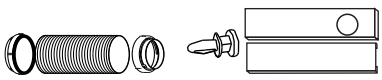
### **⚠ WARNING Electrical Information**

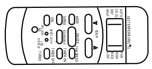
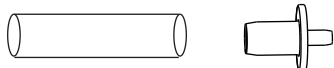
- Be sure the electrical service is adequate for the model you have chosen. This information can be found on the serial plate, which is located on the side of the cabinet and behind the grille.
- Be sure the air conditioner is properly grounded. To minimize shock and fire hazards, proper grounding is important. The power cord is equipped with a three-prong grounding plug for protection against shock hazards.
- Your air conditioner must be used in a properly grounded wall receptacle. If the wall receptacle you intend to use is not adequately grounded or protected by a time delay fuse or circuit breaker, have a qualified electrician install the proper receptacle.
- Ensure the receptacle is accessible after the unit installation.

| <b>Accessories</b>  |   |            |
|---|---|------------|
| PARTS :   | PARTS NAME :  | QUANTITY : |
|  | Adaptor A (connects unit to hose)<br>Adaptor B (connects hose to slider kit)<br>Exhaust Hose<br>Window Slider Kit and bolt                    | 1 set      |
|  | Foam seal   | 3/pcs      |
|  | Remote Controller<br>(Requires 2 AAA batteries, not included)   | 1pc        |
|  | Drain hose and drain hose adaptor   | 1pc        |
|  | Wall adaptor for through-the-wall installation<br>(not included, option to purchase)<br>Please refer to page 12 for installation instructions |            |

\* Check to ensure all accessories are included in the package. Please refer to the installation instructions for their usage.

NOTE: All the illustrations in this manual are for explanation purpose only. Your air conditioner may be slightly different. The actual shape shall prevail.

# IDENTIFICATION OF PARTS

---

## NAMES OF PARTS

### Front

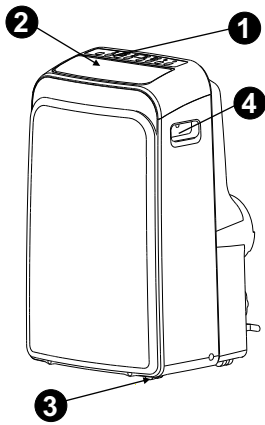

Fig.1

- ❶ Control panel
- ❷ Horizontal louver blade (swings automatically)
- ❸ Caster
- ❹ Carrying handle (both sides)

### Rear

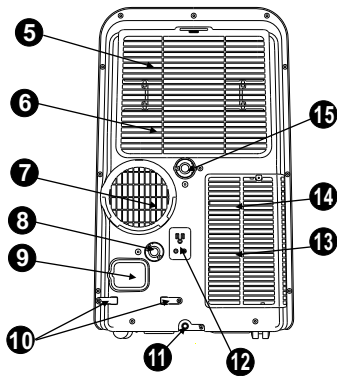

Fig.2

- ❺ Upper air filter (Behind the grille)
- ❻ Upper air intake
- ❼ Air outlet
- ❽ Drain outlet (Heating models only)
- ❾ Power cord outlet
- ❿ Power cord bracket (for storage purposes only)
- ⓫ Bottom tray drain outlet
- ⓬ Power plug socket (for storage purposes only)
- ⓭ Lower air filter (Behind the grille)
- ⓮ Lower air intake
- ⓯ Drain outlet

## AIR CONDITIONER FEATURES

### ELECTRONIC CONTROL OPERATING INSTRUCTIONS

Before you begin, thoroughly familiarize yourself with the functions of the control panel and remote controller, then follow the symbol for the functions you desire.

The unit can be controlled by the unit control panel alone or with the remote controller .

### OPERATION PANEL OF THE AIR CONDITIONER

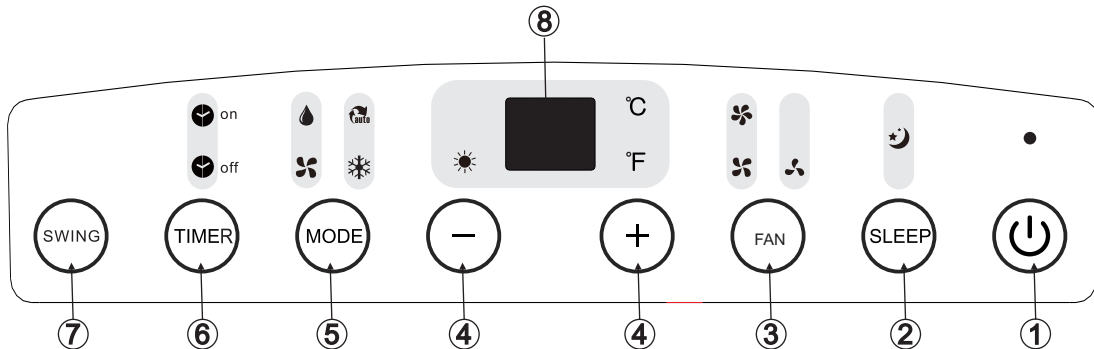

Fig.3

#### ❶ POWER button

Power switch, press to turn on/off.

#### ❷ SLEEP button

Used to initiate the SLEEP operation.

#### ❸ FAN button

Controls the fan speed. Press to select the fan speed in four steps: LOW, MED, HI and AUTO. The corresponding speed indicator light will illuminate, except for AUTO speed. When AUTO speed is selected, all fan indicators are dark.

#### ❹ UP( + ) and DOWN( - ) button

Used to increase or decrease temperature setting in 1°C or 2°F increments.  
Adjustable range: 62°F-88°F (17°C-30°C)  
Also used to set timer between 0-24 hours

NOTE: The control is capable of displaying temperature in Fahrenheit or Celsius. To convert from one to the other, press and hold the UP and DOWN buttons simultaneously for 3 seconds.

#### ❺ MODE select button

Selects the appropriate operating mode. Each press of the button will select mode in the following sequence: AUTO, COOL, DRY, FAN and HEAT(heating models only). The corresponding mode indicator light will illuminate.

#### ❻ TIMER button

Used to initiate the AUTO ON (start time) and AUTO OFF (stop time) programs. Used in conjunction with the + and - buttons. The corresponding timer indicator light will illuminate.

#### ❼ SWING button

Used to initiate the Auto swing feature. If auto-swing is in function, press the button again to stop the louver at desired angle.

#### ❽ LED Display

Displays set temperature, in either °C or °F.  
Displays auto-timer settings (if any)  
When unit is in DRY or FAN modes, displays current room temperature.

## OPERATING INSTRUCTIONS

---

### **Error codes and protection code:**

- E1-** Room temperature sensor error-  
Unplug the unit and plug it back in.  
If error repeats, call for service.
- E2-** Evaporator temperature sensor error-  
Unplug the unit and plug it back in.  
If error repeats, call for service.
- E3-** Condenser temperature sensor error-  
Unplug the unit and plug it back in. If error repeats, call for service.
- E4-** *Display panel communication error-*  
Unplug the unit and plug it back in.  
If error repeats, call for service.
- P1-** Bottom tray is full - Connect the drain hose to drain and empty the bottom tray.  
If protection repeats, call for service.

### **Operating Instructions**

#### **COOL operation**

- Press the MODE button until the "COOL" indicator light comes on.
- Press the + or - buttons to set desired room temperature. The temperature range is between 62°F-88°F (17°C-30°C).
- Press the FAN button to choose the desired fan speed.

#### **HEAT operation (heating models only)**

- Press the MODE button until the "HEAT" indicator light comes on.
- Press the + or - buttons to set desired room temperature. The temperature range is between 62°F-88°F (17°C-30°C).
- Press the FAN button to choose the desired fan speed.

#### **DRY (dehumidify) operation**

- Press the MODE button until the "DRY" indicator light comes on.
- Under this mode, you cannot select a fan speed or adjust the temperature. The fan motor operates at LOW speed.
- Keep windows and doors closed for the best dehumidifying effect.
- Do not connect exhaust hose fixture to window.

#### **AUTO operation**

- When you set the air conditioner in AUTO mode, it will automatically select cooling, heating (for heating models only), or fan mode, depending on set temperature and ambient room temperature.
- The air conditioner will operate in the appropriate mode based on the set temperature.
- Under AUTO mode, you can not select the fan speed.

#### **FAN operation**

- Press the MODE button until the "FAN " indicator light comes on.
- Press the FAN SPEED button to select desired fan speed. The temperature cannot be adjusted.
- Do not connect exhaust hose fixture to window.

#### **TIMER operation**

- When the unit is on, pressing the TIMER button will initiate the auto-stop program, the TIMER OFF indicator light will illuminate. Press the + or - buttons to set the time for unit to turn off. Press the TIMER button again within 5 seconds will initiate the auto-start program, the TIMER ON indicator light will illuminate. Press the + or - buttons to set the time for unit to turn on.
- When the unit is off, pressing the TIMER button will initiate the auto-start program; press again within 5 seconds to initiate auto-stop program.
- Press or hold the +/- button to change time in 0.5 hour increments, up to 10 hours; then in 1 hour increments, up to 24 hours. The control panel will count down the remaining time until program begins.
- The display will automatically revert back to displaying the previous temperature setting if there is no activity within a 5 second period.
- After timer has been programmed, if unit is manually turned ON or OFF; or if the timer setting is adjusted to 0.0, any timer programmed will be cancelled.
- When unit malfunctions and error codes E1, E2, E3 or E4 is displayed, timer programs will also be cancelled.



### **SLEEP operation**

- If unit is running in COOL mode when SLEEP function is activated, unit will automatically increase set temperature by 1°C/2°F after 30 minutes. After another 30 minutes, unit will again increase temperature by 1°C/2°F.
- If unit is running in HEAT mode (heating models only) when SLEEP function is activated, unit will automatically decrease set temperature by 1°C/2°F after 30 minutes. After another 30 minutes, unit will again decrease temperature by 1°C/2°F.
- Unit will maintain the new temperature for 7 hours, then returns to original set temperature. This ends the Sleep function and unit will continue to operate as originally programmed.

**Note:** This feature is unavailable under FAN or DRY mode

### **Other features**

#### **Auto-Restart**

If the unit breaks off unexpectedly due to power cut, it will restart at previous function when the power resumes.

#### **Wait 3 minutes before resuming operation**

After the unit has stopped (or powered off), there will be a 3-minute delay before unit will start up again. This is to protect the compressor. Operation will automatically resume after 3 minutes.

#### **Air flow direction adjustment**

The louver can be adjusted automatically (Fig. 4):

- When unit powers ON, the louver opens fully.
- Press the SWING button on the panel or remote controller to initiate the Auto swing feature. The louver will automatically swing up and down.
- Press SWING button again at desired angle for set air flow.
- Please do not adjust the louver manually.

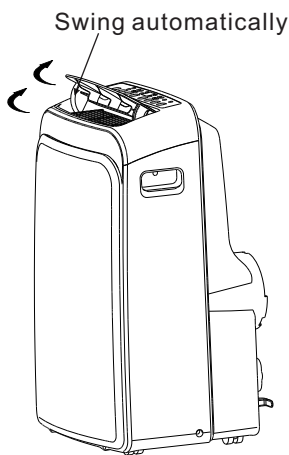
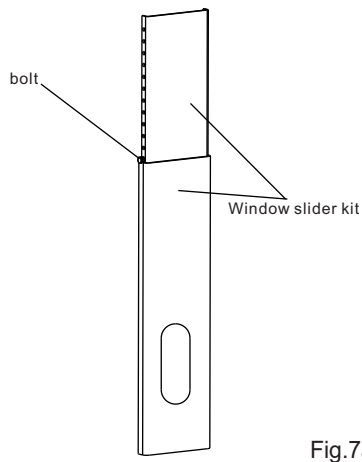
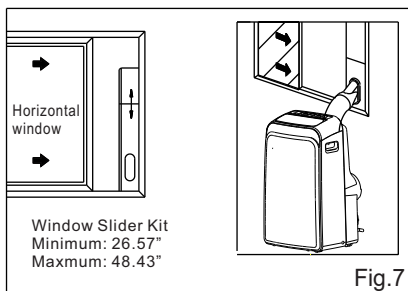
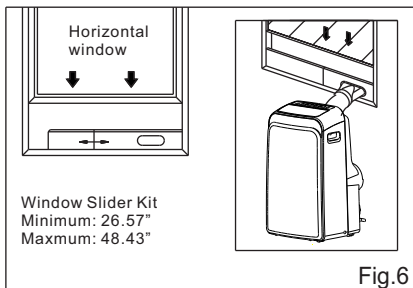
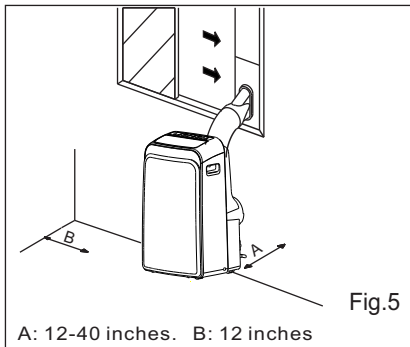

Fig.4

## INSTALLATION INSTRUCTIONS



## INSTALLATION INSTRUCTIONS

### Location

- The air conditioner should be placed on a firm foundation to minimize noise and vibration. For safe and secure positioning, place the unit on a smooth, level floor strong enough to support the unit.
- The unit has casters to aid placement, but it should only be rolled on smooth, flat surfaces. Use caution when rolling on carpet. Do not attempt to roll the unit over objects.
- The unit must be placed within reach of a properly grounded socket.
- Never place any obstacles around the air inlet or outlet of the unit.
- Allow 12 to 40 inches of space between the back of the unit and the wall for efficient air-conditioning.

### Window slider kit Installation

Your window slider kit has been designed to fit most standard vertical and horizontal window applications. However, it may be necessary for you to improvise or modify some aspects of the installation procedures for certain types of windows. Please refer to Fig. 6 and Fig.7 for minimum and maximum window opening requirements.

Window slider kit can be fixed with a bolt (Fig.7a).

**Note:** If the window opening is less than the minimum required length and the slider kit needs to be cut down to size, cut the piece with the hole in it, but cut the end without the hole.

Do Not cut out the hole in the slider kit.

Slider kit length: 26.5 to 48 inches.

Window opening requirements:

Minimum = 26.57 inches

Maximum = 48.43 inches

## INSTALLATION INSTRUCTIONS

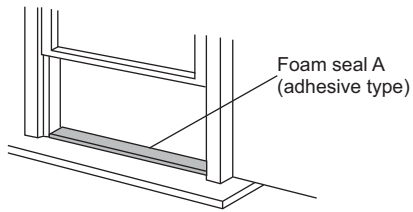

Fig.8

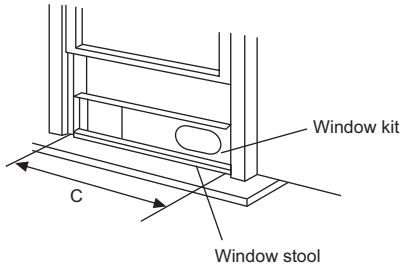

Fig.9

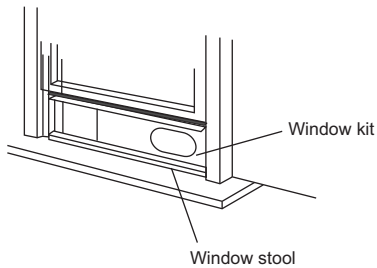

Fig.10

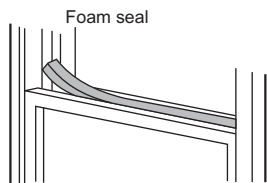

Fig.11

### Installation for a double-hung sash window

1. Trim foam seal (with adhesive) to the proper length and attach to window stool (Fig.8)
2. Adjust the length of the slider kit according to the width of the window. Place slider kit to window stool, on top of foam seal (Fig.9)
3. Trim another foam seal (with adhesive) to the proper length and place on top of the slider kit (Fig.10).
4. Close the window sash securely against the kit.
5. Trim the last foam seal to the proper length to seal the open gap between the top window sash and outer window sash (Fig.11)

# INSTALLATION INSTRUCTIONS

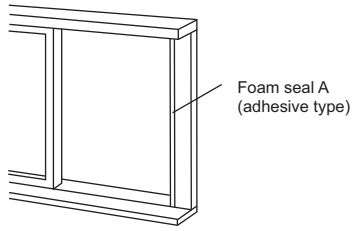

Fig.12

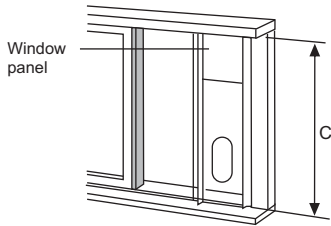

Fig.13

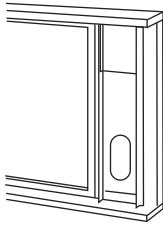

Fig.14

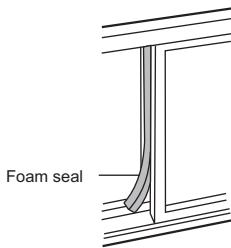

Fig.15

## Installation for sliding sash window

1. Trim foam seal (with adhesive) to the proper length and attach to window frame (Fig.12).
2. Adjust the length of the slider kit according to the height of the window. Place window slider kit against foam seal (Fig.13).
3. Trim another foam seal (with adhesive) to the proper length and attach it to the open side of slider kit (Fig.14).
4. Slide window close against the slider kit.
5. Trim the last foam seal to the proper length to seal the open gap between the two window sashes (Fig.15).

**NOTE:** All illustrations in this manual are for explanation purposes only. Your unit may differ slightly. The actual shape shall prevail.

# INSTALLATION INSTRUCTIONS

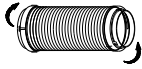

Fig. 16

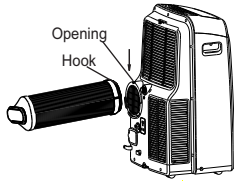

Fig. 17

## Exhaust hose installation:

The exhaust hose and adaptor must be installed or removed in accordance with the usage mode.

|   |         |
|---|---------|
| COOL, HEAT (heating models only) or AUTO mode | Install |
| FAN or DEHUMIDIFY mode                        | Remove  |

1. Attach both adaptors A and B to exhaust hose. Extend each end of the hose by couple inches and turn the adaptors as shown in Fig.16. Do not over-tighten. Refer to previous pages for window kit installation.
2. Align the hooks on adaptor A to the openings of the air outlet. Insert and slide downwards to install. (Fig. 17)

## Through-the wall connection

**NOTE:** It is necessary to purchase the following parts for through-the-wall installation:

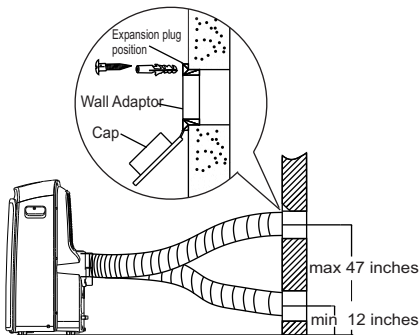

Fig. 18

|  |   |
|--|---|
|  | Wall Adaptor<br>(sold separately, please contact Sunpentown at 1-800-330-0388 or visit <a href="http://www.sunpentown.com">www.sunpentown.com</a> ) |
|  | Screws & expansion plugs<br>(can be purchased at any hardware store)  |

1. Prepare a hole in the wall and install the Wall Adaptor to the opening (from outside). Secure with 4 expansion plugs and screws. (Fig.18)
2. Attach exhaust hose to the Wall Adaptor.

**Note:** Cover the hole using the adaptor cap when not in use.

### IMPORTANT:

DO NOT OVER BEND THE EXHAUST HOSE (SEE Fig.19)

The exhaust hose can be compressed or extended moderately according to the installation requirement, but it is desirable to keep the hose length to a minimum.

### ⚠ CAUTION:

Make sure there are no obstacles blocking the air outlet of the exhaust hose (in the range of 20 inches), for the exhaust system to work properly.

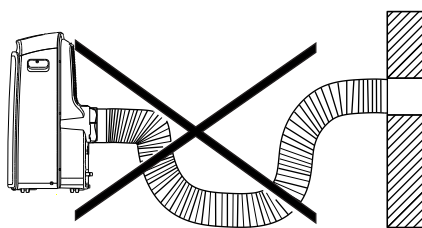

Fig. 19

# INSTALLATION INSTRUCTIONS

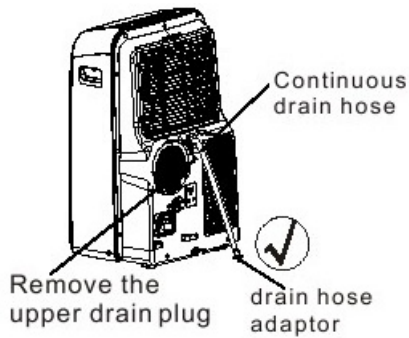

Fig.20a

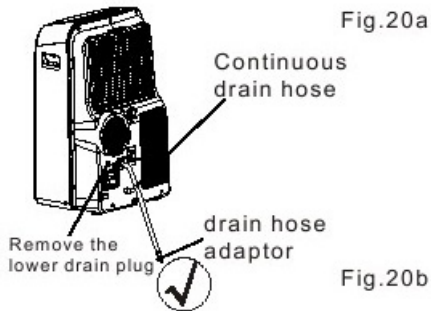

Fig.20b

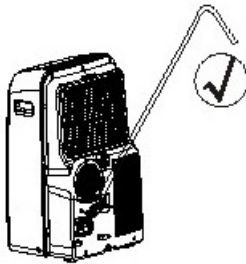

Fig.21a

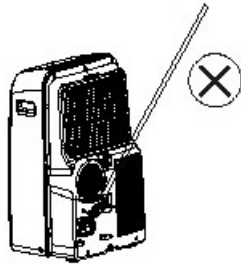

Fig.21b

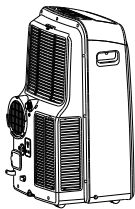

Fig.22

## Water drainage:

### Continuous Drainage - COOL/DRY modes

- Remove the upper drain plug from back of unit.
- Attach drain connector (5/8" universal female mender) to a 3/4" hose (not included, purchase from any hardware store). Connect to spout.
- Position the open end directly over drain area. (Fig.20a)

### Continuous Drainage - HEAT mode (heating models only)

- Remove the lower drain plug from back of the unit.
- Attach drain connector (5/8" universal female mender) to a 3/4" hose (not included, purchase from any hardware store). Connect to spout.
- Position the open end directly over drain area. (Fig.20b)

NOTE: Make sure connections are secure to prevent leakage. Direct the hose downwards, as water drainage is gravity-pulled, make sure there are no kinks that may stop the water flow. Never direct the hose upwards as in Fig. 21a and 21b.

### Emptying the Water Tank

- When the water in the bottom tray reaches its maximum capacity, the unit will beep 8 times and display will show "P1". At this time, the compressor will immediately stop (AC, Dry or Heat) but fan will continue to operate.
- Place a collection pan underneath the drain spout or carefully move the unit to a drain location.
- Remove the bottom drain plug and water will begin to drain out. Fig.22
- Replace the drain plug and restart unit. P1 indication should disappear.

Note: Be sure to replace the drain plug before restarting the unit.

## CARE AND MAINTENANCE

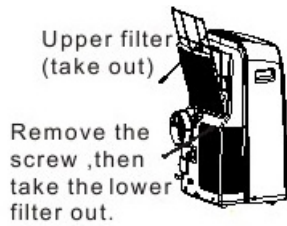

Fig.23

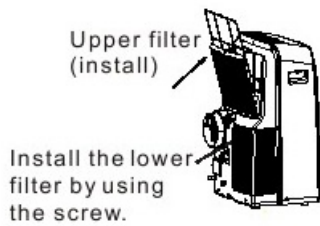

Fig.24

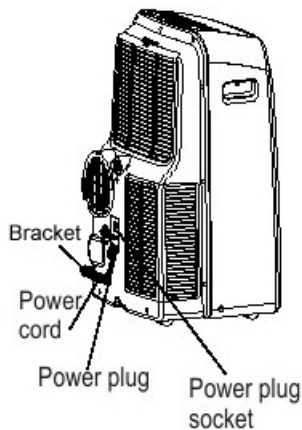

Fig.25

- 1) Be sure to unplug the unit before cleaning or servicing.
- 2) Do not use gasoline, thinner or other chemicals to clean the unit.
- 3) Do not wash the unit directly under a tap or spray with water hose. It may cause electrical danger.
- 4) If the power cord is damaged, it should be repaired by manufacture or its certified electrician.

### 1. Air filter

- Clean the air filter at least once every two weeks to prevent inferior fan operation due to dust accumulation.
- Removal (This unit has two filters)  
Upper Filter: Pull and remove according to arrow direction in Fig. 23.  
Lower Filter: First remove the screw as indicated in Fig.23, remove filter.
- Cleaning  
Wash the air filters by immersing gently in warm water (about 40°C/104°F) with a neutral detergent. Rinse the filters and allow to dry completely in a shady area - do not place under direct sunlight.
- Mounting  
Replace upper filter according to arrow direction in Fig.24  
Replace lower filter and reinsert the screw. (Fig.24)

### 2. Housing

- Use a lint-free cloth soaked with neutral detergent to clean the unit's housing. Finished by a dry clean cloth.

### 3. Storage

- Remove the rubber plug at the back of the unit and attach a hose to drain outlet. Place the open end of the hose directly over the drain area (See Fig.20 & 21).
- Drain water from the bottom tray by removing the plug from the bottom drain outlet (See Fig.22).
- Turn unit on and run in FAN for half a day in a warm room. This will dry the inside of the unit and prevent mold and mildew growth.
- Power off the unit and unplug from power source. Wrap the cord around the bracket and insert plug into the storage socket. (Fig.25)
- Clean both filters and reinstall.
- Remove batteries from the remote and store with unit.
- Cover with a plastic bag and store in a cool, dry place.

## **TROUBLESHOOTING TIPS**

### **TROUBLE SHOOTING**

| <b>TROUBLES</b>   | <b>POSSIBLE CAUSES</b>  | <b>SUGGEST REMEDIES</b>                                  |
|---|---|--|
| <b>1. Unit will not start</b>                                   | - P1 appears in the display window  | Drain the water in the bottom tray.                      |
|   | - Room temperature is lower than the set temperature.(Cooling mode)   | Adjust the set temperature.                              |
| <b>2. Not cool enough</b>                                       | - The windows or doors in the room are not closed.  | Make sure all the windows and doors are closed.          |
|   | - There are heat sources inside the room.   | Remove the heat sources if possible.                     |
|   | - Exhaust air duct is not connected or blocked.   | Connect the duct and make sure it can function properly. |
|   | - Temperature setting is too high.  | Decrease the set temperature.                            |
|   | - Air filters are dirty.  | Clean the air filters.                                   |
| <b>4. Noisy or vibration</b>                                    | - The ground is not level or not flat enough.   | Place the unit on a flat, level ground if possible.      |
| <b>5. Gurgling sound</b>  | - This is the sound of refrigerant flowing inside the unit.   | This is normal.  |
| <b>6. Power shuts off in Heat mode</b><br>(heating models only) | - Overheat protection. When the temperature at the air outlet exceeds 70°C/158°F, the unit will automatically shut off as a protection feature. | Switch on again after the unit has cooled down.          |



## HANDLING THE REMOTE CONTROLLER

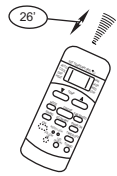
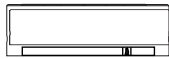

### Location of the remote controller.

- Use the remote controller within a distance of 26 feet from the appliance, pointing it towards the receiver. Reception is confirmed by a beep.

### ▲ CAUTIONS

- The air conditioner will not respond if curtains, doors or other barriers block the signal from the remote controller to the unit.
- Prevent any liquid from coming in contact with the remote controller. Do not expose the remote controller to direct sunlight or heat.
- If the infrared signal receiver on the unit is exposed to direct sunlight, the air conditioner may not respond. Close curtains/blinds to block sunlight from falling on the receiver.
- If other electrical appliances react to the remote controller, move those appliances if possible.

### Replacing batteries

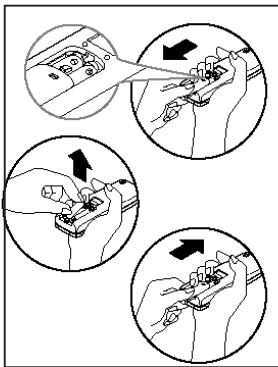

The remote controller is powered by two AAA batteries (not included). The batteries are housed in the back of remote, protected by a cover.

- (1) Remove the cover by pressing down and sliding off.
- (2) Remove the old batteries and insert new batteries, placing the (+) and (-) ends correctly.
- (3) Replace cover by sliding it back into position.

**NOTE:** When the batteries are removed, any programming will be erased. After inserting the new batteries, the remote controller can be reprogrammed.

### ▲ CAUTIONS

- Do not mix old and new batteries or batteries of a different type.
- Do not leave the batteries in the remote controller if it is not going to be used for extended period of time (2 months or more).
- Dispose old batteries at recycling centers - contact your local government for disposal practices in your area.

### Performance Feature

1. Operating Mode: AUTO, COOL, DRY, HEAT (Heating models only) and FAN.
2. Timer Setting Function in 24 hours.
3. Indoor Setting Temperature Range: 62°F to 88°F (17°C to 30°C)
4. Full function of LCD (Liquid Crystal Display)

(Operating temperature: -41°F to 140°F (-5°C to 60°C))

**NOTE:** All illustrations in this manual are for explanation purpose only. Your air conditioner may be differ slightly. The actual shape shall prevail.

# HANDLING THE REMOTE CONTROLLER

## Function buttons

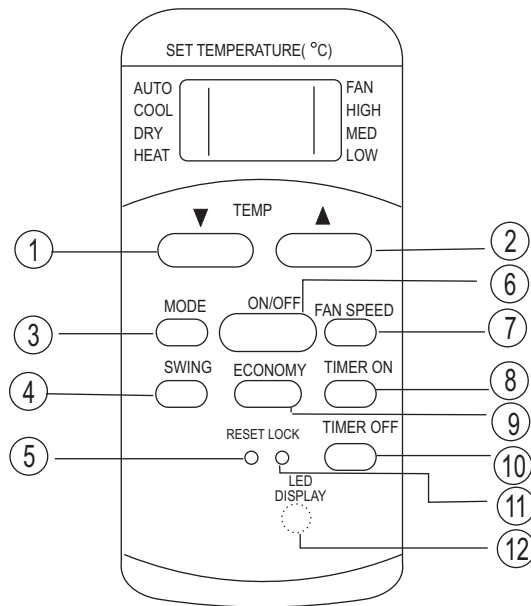

### ❶ TEMP DOWN Button

Push this button to decrease set temperature, in increments of 2°F (1°C). Lowest is 62°F (17°C°)

### ❷ TEMP UP Button

Push this button to increase set temperature, in increments of 2°F (1°C). Highest 88°F (30°C°)

### ❸ MODE Button

Each time the button is pressed, the operation mode is selected in the following sequence:



**NOTE:** Heat mode is for Cooling & Heating models only.

### ❹ SWING Button

Press to start/stop auto swing feature. Or to set desired angle for directional airflow.

### ❺ RESET Button

If the recessed RESET button is pressed, all current settings will be cancelled and the controller will return to the default settings.

### ❻ ON/OFF Button

Power button, press to turn unit ON/OFF.

### ❼ FAN SPEED Button

Press to select the fan speed in four steps:

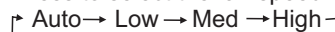

### ❽ TIMER ON Button

Press to activate Auto-on timer. Each press increases the timer setting by 30-minutes, up to 10 hours. Then at 1-hour increments, up to 24 hours. To cancel the Auto-on timer, press the button until time setting is 0.0.

### ❾ ECONOMY(SLEEP) Button

Press to engage Sleep mode. Select this function for the sleeping hours to maintain the most comfortable temperature and save energy. This function is only available under AUTO, COOL and HEAT (heating models) modes.

**NOTE:** SLEEP function would be cancelled if ON/OFF, FAN SPEED, SLEEP or MODE button is pressed.

### ❿ TIMRT OFF Button

Press to activate Auto-off timer. Each press increases the timer setting by 30-minutes, up to 10 hours. Then at 1-hour increments, up to 24 hours. To cancel the Auto-off timer, press the button until time setting is 0.0.

### ⓫ LOCK Button

Press this recessed button to lock all current settings (a lock symbol will appear on the LCD). When the remote is locked, it will not respond to any actions except LOCK. Use the LOCK mode when you want to prevent any accidental setting changes. Press again to unlock

### ⓬ LED Display Button

Press this button to turn off the display on the unit, press it again to light the display .

# HANDLING THE REMOTE CONTROLLER

## Indicators on LCD

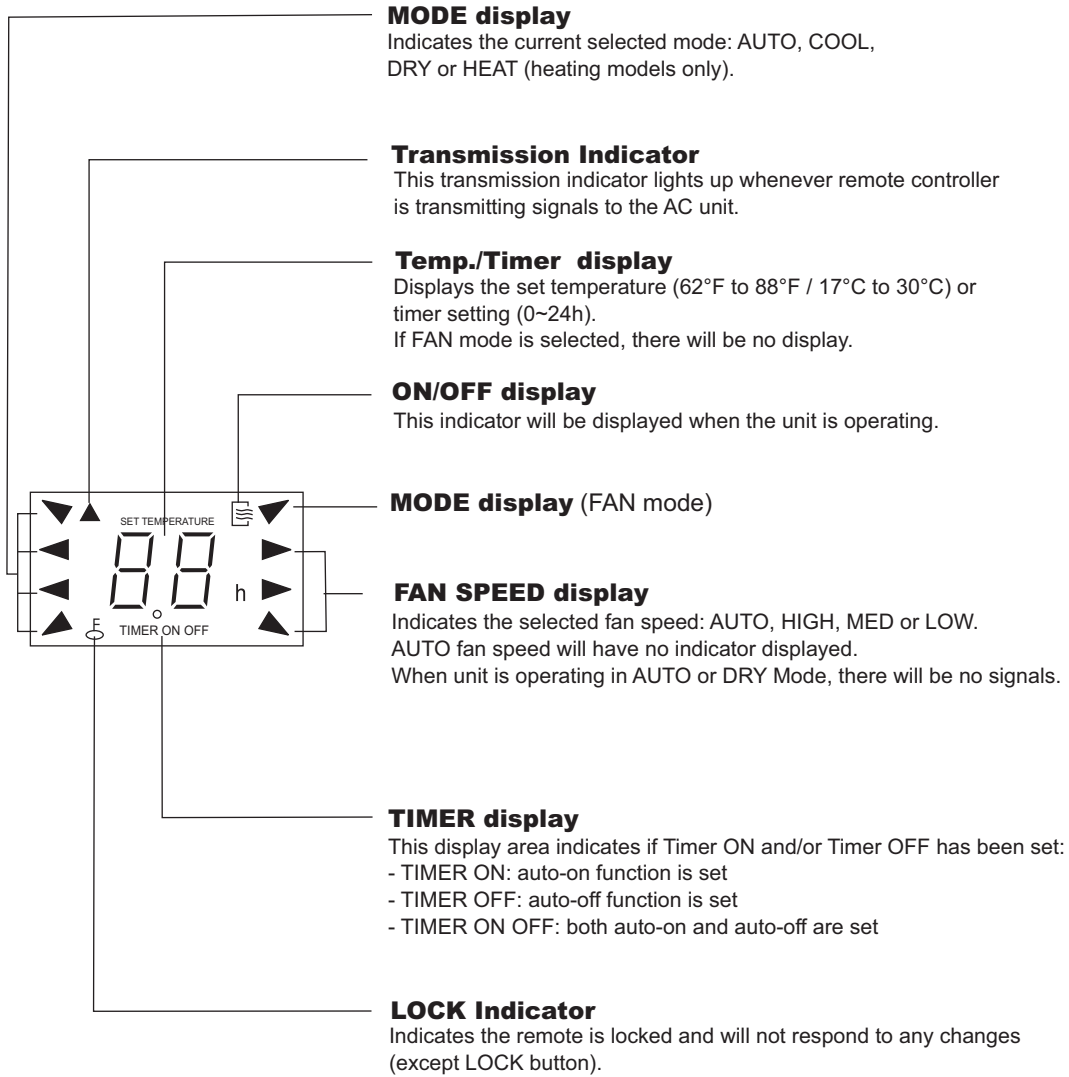

# HANDLING THE REMOTE CONTROLLER

## Using the remote controller

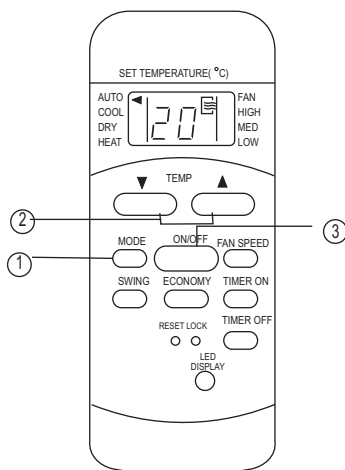

### Auto operation

Ensure the unit is plugged in and power is available.

1. Press the **MODE** button to select Auto.
2. Press the **TEMP** up/down button to set desired temperature, between 62°F to 88°F (17°C to 30°C). Each press is in increments of 2°F or 1°C.
3. Press the **ON/OFF** button to start the air conditioner.

#### NOTE:

- Under Auto mode, the unit will sense the difference between ambient temperature and set temperature to determine the operating mode: COOL, FAN or HEAT (heating models only).
- Fan speed cannot be controlled in Auto mode. Unit automatically selects the most appropriate speed.
- If Auto mode is not comfortable for you, the desired mode can be selected manually.

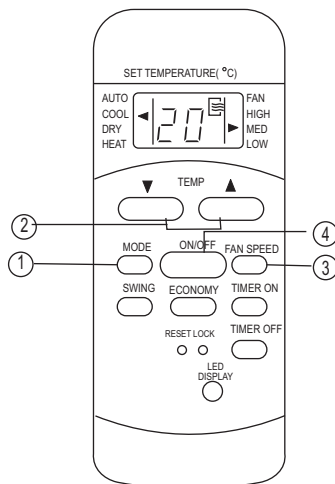

### Cooling /Heating/Fan operation

Ensure the unit is plugged in and power is available.

1. Press the **MODE** button to select COOL, HEAT (heating models only) or FAN mode.
2. Press the **TEMP** up/down button to set desired temperature, between 62°F to 88°F (17°C to 30°C). Each press is in increments of 2°F or 1°C.
3. Press the **FAN SPEED** button to select fan speed: Auto, Low, Med or High.
4. Press the **ON/OFF** button to start the AC unit.

#### NOTE:

*In FAN mode, temperature setting is not applicable. There will be no temperature displayed on the LCD. Only steps 1, 3 and 4 may be performed.*

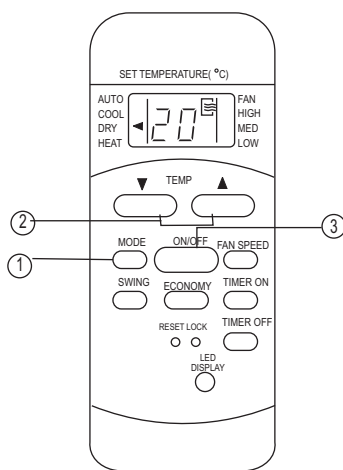

### Dry (Dehumidifying) operation

Ensure the unit is plugged in and power is available.

1. Press the **MODE** button to select DRY mode.
2. Press the **TEMP** up/down button to set desired temperature, between 62°F to 88°F (17°C to 30°C). Each press is in increments of 2°F or 1°C.
3. Press the **ON/OFF** button to start the AC unit.

#### NOTE:

*In DRY mode, fan speed is automatically controlled.*

## HANDLING THE REMOTE CONTROLLER

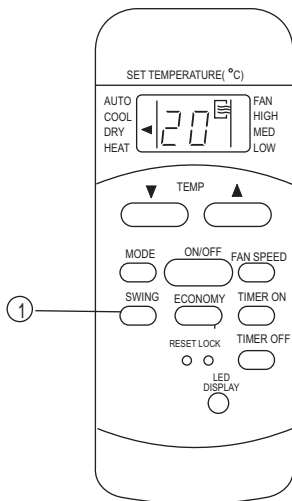

### Swing operation

Use the SWING button to adjust the Up/Down airflow direction.

1. When the button is quickly pressed once, the louver is adjusted by 6°.  
Keep pressing the button to adjust louver to desired angle.
2. Press and hold for 2 seconds to activate/deactivate auto-swing function.

**NOTE:** When the louver swings to a position which would affect the cooling (or heating) of the unit, it would automatically change the swing direction.

### Timer operation

#### To set the Auto-on timer:

1. Press the TIMER ON button and remote will display TIMER ON. The last auto-on setting and the signal "h" will also be displayed.
2. Press the TIMER ON button again to begin setting the desire time. Each press of the button increases the time by 30-minutes, up to 10 hours.  
Then by 1-hour increments, up to 24 hours.

#### To set the Auto-off timer:

1. Press the TIMER OFF button and remote will display TIMER OFF. The last auto-off setting and the signal "h" will also be displayed.
2. Press the TIMER OFF button again to begin setting the desire time. Each press of the button increases the time by 30-minutes, up to 10 hours.  
Then by 1-hour increments, up to 24 hours.

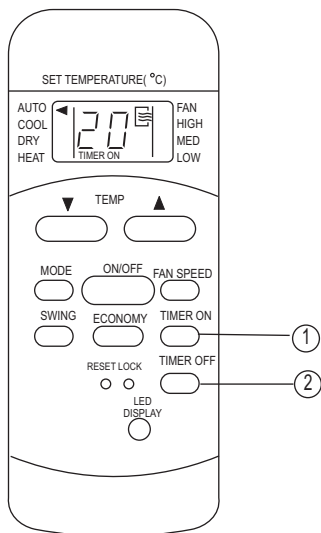

After setting TIMER ON/OFF, there will be a one-half second delay before the remote controller transmits the signal to the AC unit. The after another 2 seconds (approximately), the "h" signal will disappear and set temperature will re-appear on the display window.

**NOTE:** Timer ON/OFF is limited to the following time settings: 0.5, 1.0, 1.5, 2.0, 2.5, 3.0, 3.5, 4.0, 4.5, 5.0, 5.5, 6.0, 6.5, 7.0, 7.5, 8.0, 8.5, 9.0, 9.5, 10, 11, 12, 13, 14, 15, 16, 17, 18, 19, 20, 21, 22, 23 and 24.

### Examples of Timer setting

#### TIMER ON (auto-on operation)

The TIMER ON feature is useful when you want the unit to automatically turn on, say before you return home from work.

#### Example:

To start the AC unit in 6 hours.

1. Press the TIMER ON button. Remote displays the last time setting and the "h" signal.
2. Press the TIMER ON button repeatedly till "6:0h" is displayed on remote.
3. Wait for about 3 seconds and display will revert to show set temperature.
4. Auto-on function has been set.

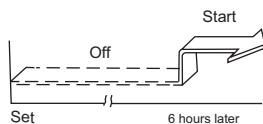

# HANDLING THE REMOTE CONTROLLER

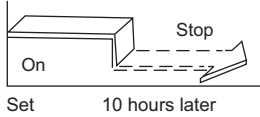
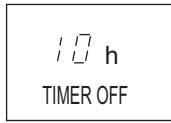

### TIMER OFF (auto-off operation)

The TIMER OFF feature is useful when you want the unit to automatically turn off, say after you go to bed.

**Example:**

To have the AC unit turn off after 10 hours:

1. Press the TIMER OFF button. Remote displays the last time setting and the "h" signal.
2. Press the TIMER OFF button repeatedly till "10h" is displayed on remote.
3. Wait for about 3 seconds and display will revert to show set temperature.
4. Auto-off function has been set.

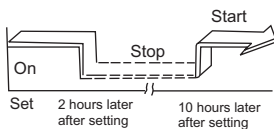
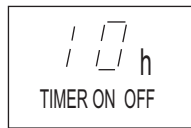

### COMBINED TIMER (auto-off / auto-on)

This feature is useful when you want the unit to stop after you leave the house and to start again upon your return.

**Example:**

To stop the AC unit in 2 hours and start up again in 10 hours.

1. Press the TIMER OFF button to initiate auto-off programming.
2. Press the TIMER OFF button repeatedly till "2.0h" is displayed.
3. Press the TIMER ON button to initiate auto-on programming.
4. Press the TIMER ON button repeatedly till "10h" is displayed.
5. Wait for about 3 seconds for display to revert back to set temperature.

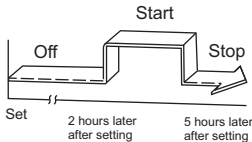

### COMBINED TIMER (auto-on / auto-off)

This feature is useful when you want the unit to start before you wake up and stop after you leave the house

**Example:**

To start the AC unit in 2 hours and stop after 5 hours.

1. Press the TIMER ON button to initiate auto-on programming.
2. Press the TIMER ON button repeatedly till "2.0h" is displayed.
3. Press the TIMER OFF button to initiate auto-off programming.
4. Press the TIMER OFF button repeatedly till "5.0h" is displayed.
5. Wait for about 3 seconds for display to revert back to set temperature.

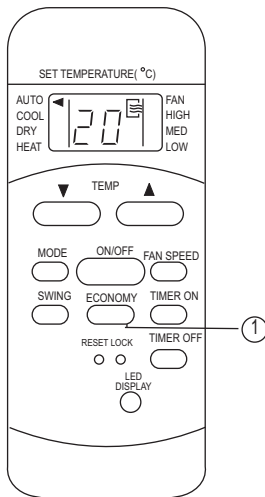

### ECONOMY(SLEEP) operation

Press ECONOMY button to engage the economic (sleep) operation. The set temperature will increase (cooling) or decrease (heating) by 1°C/2°F after 30 minutes and by another 1°C/2°F after an additional 30 minutes. The new temperature will be maintained for 7 hours before unit returns to originally set temperature.

**NOTE:** The ECONOMY (sleep) function is only available under COOL, HEAT (heating models only) and AUTO mode.



## Your Guarantee

If this product is found to be faulty as a result of faulty materials or workmanship within one year from date of purchase, it will be repaired free of charge.

This guarantee is subject to the following terms:

- Sunpentown must be notified of the fault.
- Proof of purchase must be presented to Sunpentown's nominated representative.
- The warranty will be void if the product is modified, misused or repaired by an unauthorized person.
- The warranty after repair will not be extended beyond the original one-year period.
- All replacement parts will be new or reconditioned.
- Parts, which are replaced, become the property of Sunpentown.
- The warranty applies for the use of the product in the USA only.

What is NOT COVERED:

- Warranty does not include freight charges.
- Incidental or consequential damage caused by possible defects with this product.
- Damage to product caused by improper power supply voltage, accident, fire, floods or acts of nature.
- Failure of product resulting from unauthorized modifications to the product.
- Improper installation or failure to perform the necessary maintenance.

This GUARANTEE is in addition to your Statutory Rights

**SUNPENTOWN INTERNATIONAL INC.**  
**14625 Clark Ave. City of Industry, CA 91745**  
**Tel: 800-330-0388**  
**service@sunpentown.com**  
www.sunpentown.com