

Ancerre

D E S I G N S

VTS-KAYLEIGH-48

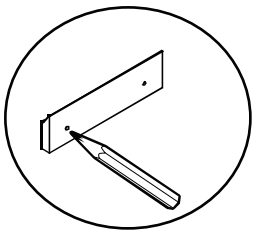

A

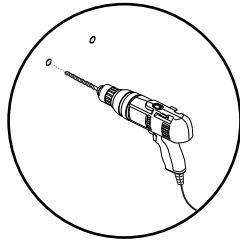

B

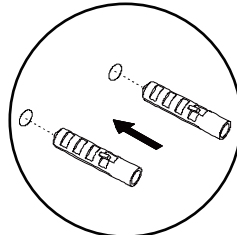

C

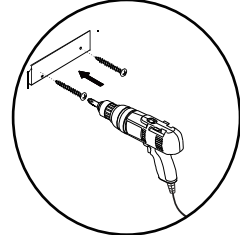

D

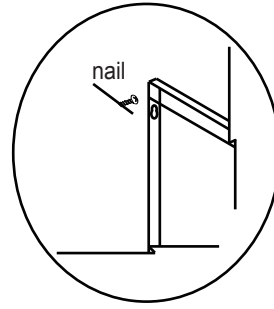

E

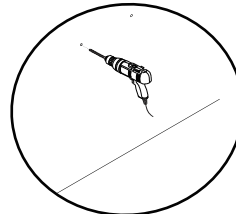

F

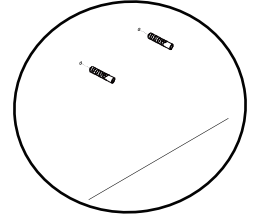

G*

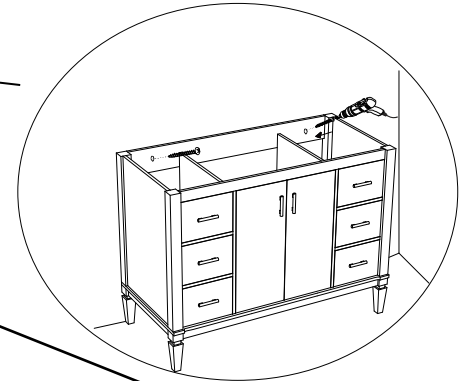
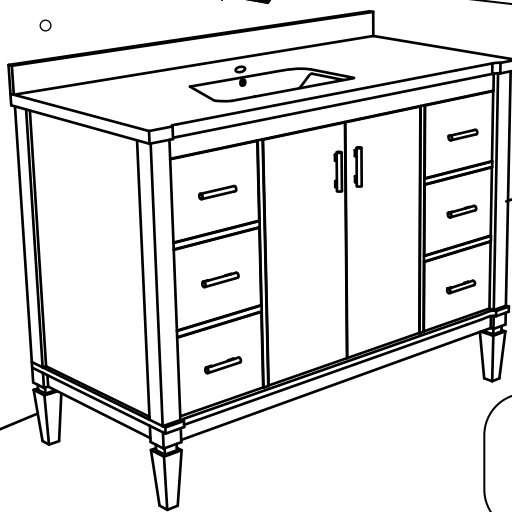
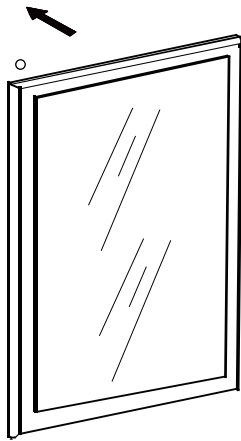

H

Adjustable leg leveler.
Adjust for level.

REQUIRED TOOLS:

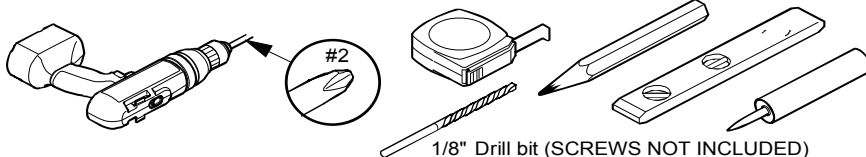

1/8" Drill bit (SCREWS NOT INCLUDED)

*SECURE SCREW TO STUDS WHEN POSSIBLE