

# WINE RACK *lattice*

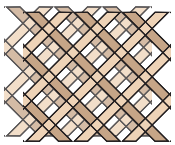

## REQUIRED *tools*



PAIR OF WINE  
LATTICE INSERTS



SAW



TAPE  
MEASURE

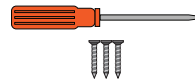

SCREWDRIVER +  
SCREWS



WOOD  
GLUE

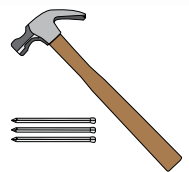

HAMMER +  
FINISHING NAILS

## BEFORE YOU *begin*

- Note that American Pro Decor wine lattice panels are sold by the pair
- Measure the inside of the cabinet or opening where the lattice panels will be inserted
- Mark and cut the two wine lattice panels to size
- After cutting the panels, make sure the ends are sanded smoothly

## BASIC *installation*

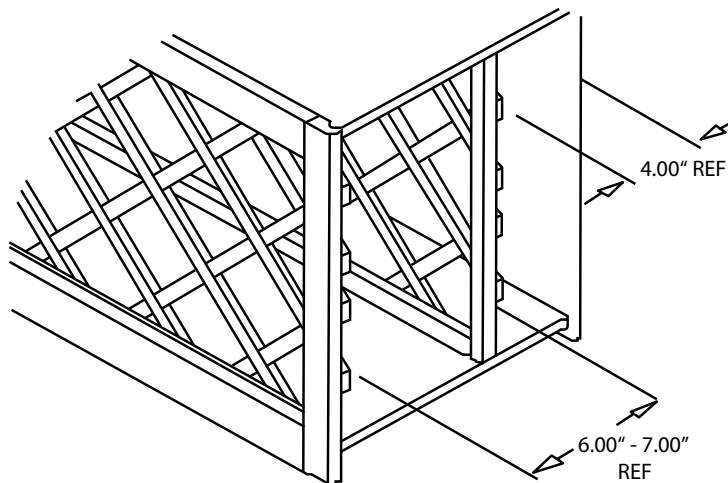
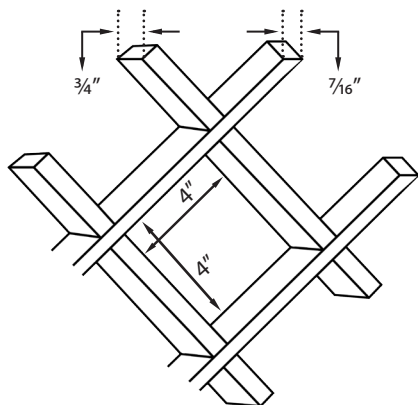

Wine lattice panels can be glued or pin nailed through the top and bottom of the cabinet.

**NOTE:** Another way of installing the lattice panels is by attaching them to the inside of frames using 1" x 2" wood strips.  
[Wood strips are not included]



# WOOD *finishing tips*

Decide which type of stain to use. You could use either an oil based or acrylic based stain. Whichever you decide, you will also be using the same type of sealer to finish up the staining process. When staining, make sure the room temperature is between 70° and 75° Fahrenheit for best results. It is very important to test your stain colors on smaller samples of wood so that you will know exactly how the finish will appear.

## REQUIRED *tools*

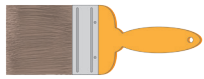

PAINT BRUSH



OIL/ACRYLIC-BASED WOOD STAIN  
OIL/ACRYLIC-BASED POLYURETHANE SEALER  
PRE-STAIN WOOD CONDITIONER

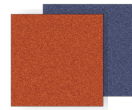

120 + 220 GRIT  
SANDPAPER

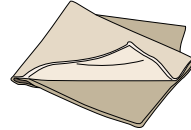

RAGS +  
CHEESE CLOTH  
TOWELS



SAFETY GOGGLES +  
PROTECTIVE MASK

## STAINING

- 1. SANDING.** American Pro Decor hardwoods are mostly ready to be stained. However, there will instances where the wood will need to be sanded down to remove scratches, etc. Brush off any debris once sanding is complete.
- 2. PRE-STAINING WOODS.** Not all woods are uniform in color or texture. Woods are porous with different densities, therefore, wood will absorb the stain in an uneven manner. To obtain a consistent and even finish, use a pre-stain wood conditioner found at any home store. The pre-stain wood conditioner should be applied on the raw wood using a cloth or brush. Allow it to penetrate for about 10 to 15 minutes. Remove any excess afterwards. The stain should be applied with 2 hours.
- 3. STAINING.** Apply the stain with a wide brush evenly or a rag. Make sure your area is well ventilated. Stains will produce fumes. When applying, always go with the grain and against the grain as well. The purpose is to apply the stain to cover all visible surfaces. It depends on how light or dark you need the wood to be. If you need a lighter look, wipe off the stain immediately. For a darker tone, leave the stain for 5 to 10 minutes before wiping it. When cleaning off the stain residue, go in the direction of the grain so that the stain will penetrate into the grain of the wood. If a second coat is required, it is advisable to lightly sand the wood with the 120 grit sandpaper and wipe off any debris. Brushes are better for staining ornate carvings and other hard to reach areas. Rags are best for flat surfaces. If you are an experienced wood worker, you could achieve an antique finish by using watered down black paint and brush it into the cracks and details or your wood ornaments. After a few minutes of applying the watered down black paint, wipe off any excess. This will add a beautiful accent to your carved wood ornaments.
- 4. SEALING YOUR WOOD.** Remember, stain will only provide color to you wood **NOT A FINISH**. Therefore, you need to apply a sealer. Remember to use the same base type of material. That is oil based stain to oil based sealer, acrylic based stain to acrylic based sealer. Apply using a brush or sprayer. Let it dry. If needed, sand with 220 grit sandpaper. Wipe clean and apply another coat of the polyurethane sealer. Sealers are mostly known as varnish, shellac or wood polish.