

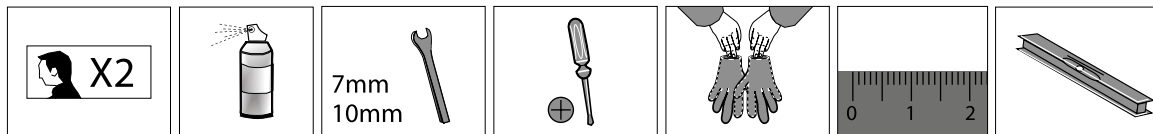

Assembly Instructions

Crystal Clear Plant Inn

118 L x 118 W 146.5 H cm / 46½" L x 46½" W x 57¾" H

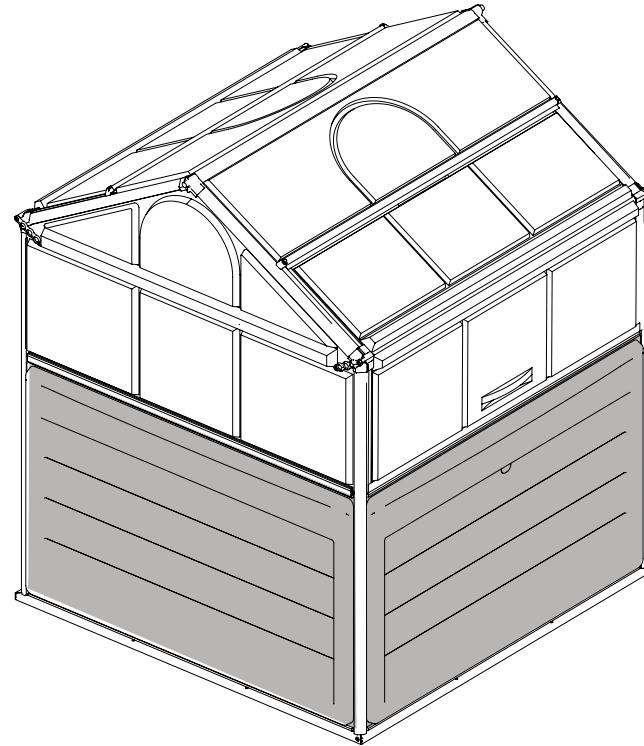

English_71989

Company information:
Palram Americas Inc.
9735 Commerce Parkway
Kutztown, PA, USA

Greenhouse Service Center:
Toll Free: (877) 627-8476

E-Mail: greenhouseUSA.support@palram.com

www.palramapplications.com



IMPORTANT

Please read these instructions carefully before you start to assemble this product.
Keep these instructions in a safe place for future reference.

⇒ **Customer Service**

For assistance with assembly, replacement parts or any other additional information please log onto our website or call our customer service line (number is on the title page).
www.palramapplications.com www.palramapplications.com

⇒ **Safety advice**

- It is of utmost importance to assemble all of the parts according to the directions. Do not skip any step.
- We strongly recommend using work gloves during assembly.
- Always wear shoes and safety goggles when working with extruded aluminium.
- If using a step ladder or power tools ensure that you follow the manufacturer's safety advice.
- Do not touch overhead power cables with the aluminium profiles.
- Do not attempt to assemble the product in windy or wet conditions.
- Dispose of all plastic bags safely keep them out of reach of small children.
- Keep children away from the assembly area.
- Do not lean against or push the product during construction.
- Do not position your product in an area exposed to excessive wind.
- Do not attempt to assemble this product if you are tired, have taken drugs or alcohol or if you are prone to dizzy spell.
- From safety reasons always use the lockers for each position (close, open, ventilation, storage) as shown in step 33 Hot items such as recently used grills, blowtorches etc. must not be stored in the product. Ensure there are no hidden pipes or cables in the ground before inserting the pegs.
- This product is designed to use as growhouse only.

⇒ **Care & Maintenance**

•When your product needs to be cleaned, use a mild detergent solution and rinse with cold clean water. DO NOT use acetone, abrasive cleaners or other special detergents to clean the clear panels.

⇒ **Tools & Equipment**

- Tape measure
- Work gloves
- Lubricant
- Phillips head screwdriver
- Step ladder
- Drill bit
- Large hammer
- Spanner

- T001 - Special tool for Screws 411 and nuts 412

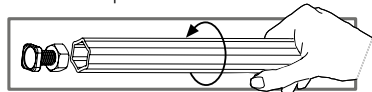

- Silicon spray

⇒ **Before Assembly**

This is a multi-part assembly best achieved by two people.
Allow at least half a day for assembly process.

Selecting a site - the product must be assembled, positioned and fixed on a flat level surface.

Choose a sunny position away from overhanging trees.

Take out all components parts of the packages. Sort the parts and check against the contents parts list.

During assembly parts should be laid out close at hand. Keep all small parts (screws etc.) in a bowl so they do not get lost.

⇒ **Notice**

Step 8 – make sure screws are strongly tighten.

If trays are dropping down when filled with soil, push trays' frame up and tight these screws again on their original position.

Step 27-28 – make sure profiles are inserted all the way till the end into plastic connector.

Steps 30 – If lid does not located correctly on the frame it will not closed and opened properly.

Try re-checking **step 23** (measure) and **step 27+28** (insert profiles all the way).

For easy inserting of profile 960 use lubricant material or move lid up and down. Do not use hammer.

⇒ **After assembly**

This product's ground fixing is based on soil weight. When trays are empty it should be kept from winds. There for we are strongly recommending fixing the product directly to a solid concrete foundation.

IMPORTANTE

Lea por favor estas instrucciones cuidadosamente antes de comenzar a montar este producto. Mantenga estas instrucciones en un lugar seguro para referencia futura.

⇒ **Servicio de Ayuda al Cliente**

Para obtener ayuda con el montaje, con piezas de recambio o cualquier otra información adicional, por favor entre a nuestro sitio web o llame a nuestra línea de servicio al cliente (el número está en la página de título) www.palramapplications.com

⇒ **Consejos de Seguridad**

- Es de suma importancia montar todas las partes de acuerdo con las instrucciones. No salte ningún paso.
- Recomendamos firmemente el uso de guantes del trabajo durante el montaje.
- Use siempre zapatos y anteojos de seguridad al trabajar con aluminio extruido.
- Al usar una escalera plegable o herramientas eléctricas asegúrese de seguir los consejos de seguridad del fabricante.
- No toque los cables eléctricos aéreos con los perfiles de aluminio.
- No intente montar este producto en días de viento o en condiciones de humedad.
- Disponga de todas las bolsas plásticas en lugar seguro - guárdelas fuera del alcance de niños.
- Mantenga a los niños fuera del área de montaje.
- No se apoye ni empuje este producto durante la construcción.
- No coloque su producto en un área expuesta al viento excesivo.
- No procure montar este producto si usted está cansado, ha tomado drogas o alcohol, o si usted es propenso a ataques de mareo.
- Por razones de seguridad utilice siempre los armarios para cada posición (cerrado, abierto, ventilación, almacenaje) como presentado en el paso 33. Artículos calientes recientemente usados tales como parrillas, sopletes etc. no deben ser almacenados en el producto. Asegúrese de que no haya ninguna tubería o cables ocultos en la tierra antes de insertar las clavijas.
- Este producto es designado a ser usado solamente como invernadero.

⇒ **Cuidados & Mantenimiento**

Cuando su producto necesita ser limpiado, utilice una solución detergente suave y enjuague con agua limpia fría. **NO** utilice acetona, limpiadores abrasivos u otros detergentes especiales para limpiar los paneles.

⇒ **Herramientas & Equipo**

- Cinta métrica
- Guantes de trabajo
- Lubricante
- Destornillador cabeza Phillips
- Escalera plegable
- Broca
- Martillo grande
- Llave inglesa

- T001 - Herramienta especial para Tornillos 411 y tuercas 412

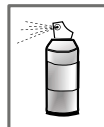

- Spray de silicona

⇒ **Antes del Montaje**

Esto es un montaje de varias partes, mejor ejecutado por dos personas.

Dé un plazo de por lo menos medio día para el proceso de montaje.

Seleccionar un sitio – el producto debe ser montado, posicionado y fijo en una superficie plana.

Elija un lugar soleado lejos de árboles con ramas colgantes.

Saque todas las partes componentes de los paquetes. Clasifique las partes y compruebe contra la lista del contenido.

Durante el montaje las partes deben ser colocadas cerca del alcance de la mano. Guarde todas las piezas pequeñas (tornillos etc.) en un tazón para que no se pierdan.

⇒ **Observación**

Paso 8 – erciórese de que los tornillos estén firmemente apretados.

Si las bandejas se caen cuando llenadas con tierra, empuje el marco de las bandejas hacia arriba y apriete estos tornillos otra vez en su posición original.

Pasos 27-28 – cerciórese de que los perfiles estén totalmente insertados hasta el extremo en el conector plástico.

Pasos 30 – Si la tapa no está colocada correctamente en el marco, no se cerrará ni abrirá apropiadamente.



Intente volver a inspeccionar el **paso 23** (medición) y los **pasos 27+28** (insertar los perfiles hasta el final).



Para la fácil inserción del perfil 960 use material lubricante o mueva la tapa hacia arriba y abajo. No utilice martillo.

⇒ **Después del Montaje**

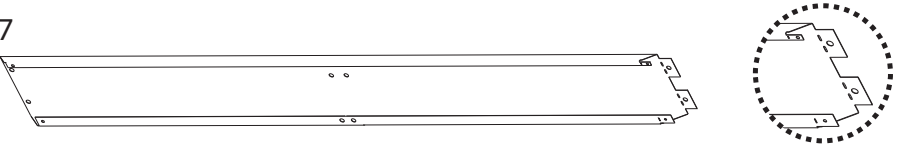
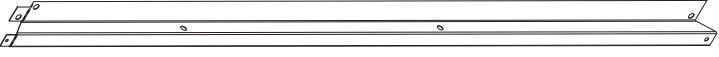
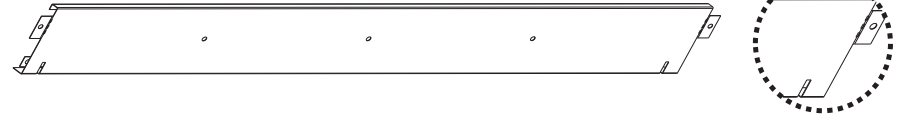
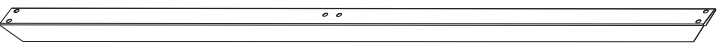

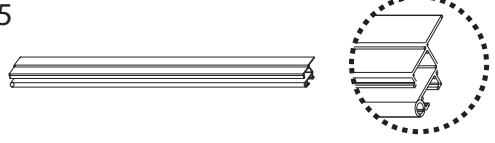
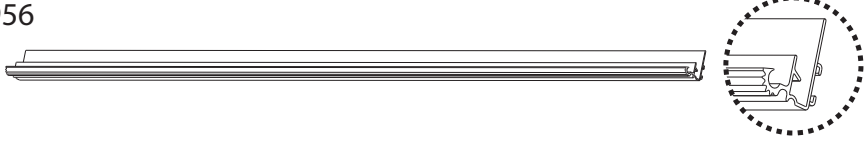

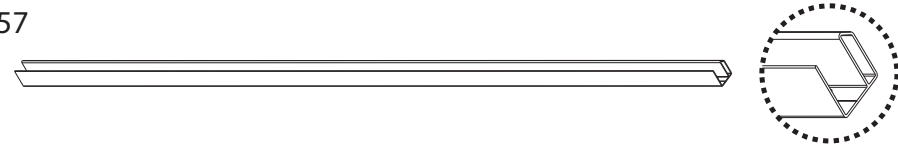
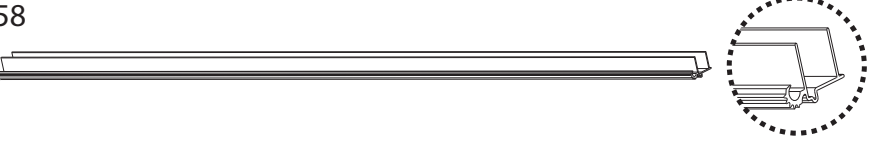

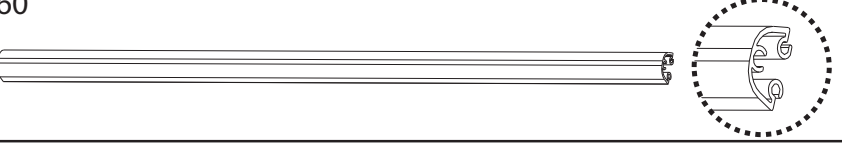
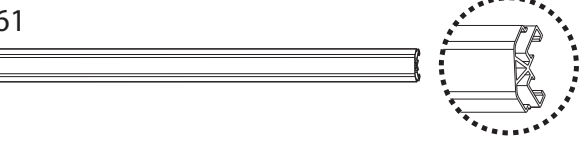
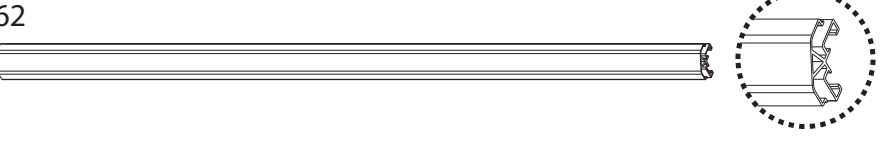
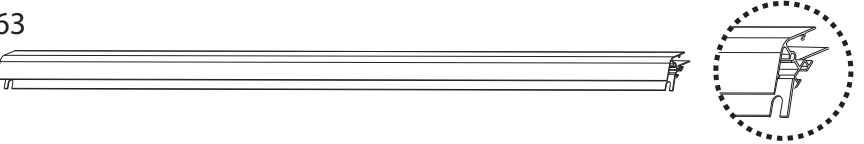



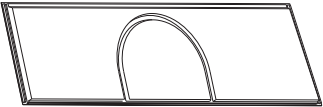
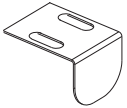
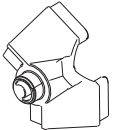

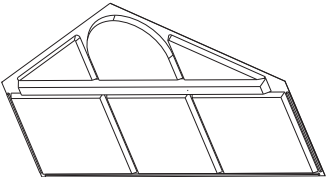
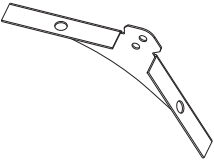
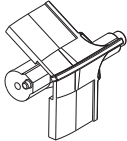

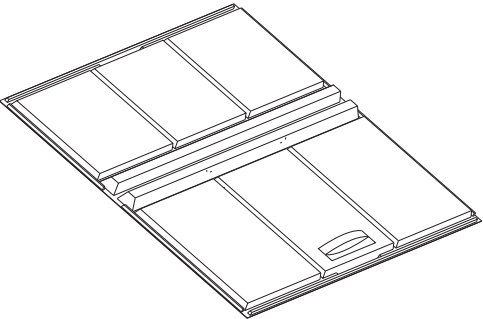
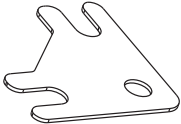
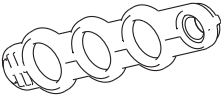

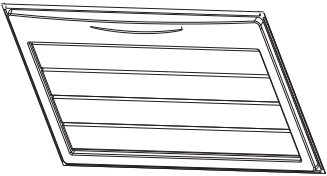

La fijación en el piso de este producto está basada en el peso del suelo. Cuando las bandejas están vacías deben ser protegidas de los vientos. Por lo tanto, recomendamos firmemente que fije este producto directamente a una fundación de concreto sólido.

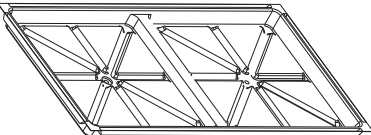
Contents

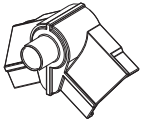
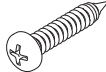
Item		Qty.
127		4
128		4
129		2
130		1
954		4
955		4
956		2

Item		Qty.
957		2
958		2
959		2
960		2
961		4
962		4
963		1

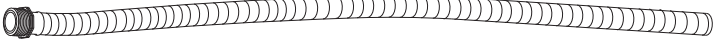
Contents

Item	Qty.	Item	Qty.	Item	Qty.	Item	Qty.
295	2	150		290	4	447	30
							2
296	2	131	8	302	4	4016	5
							1
297	2	139	4	291	4	413	5
							1
298	4	411	69	301	4	4021	5
			4				1
299	2	412	73	289	2	4026	9
			4				1
		70	10	T001	1	4043	5
							1
		69	4	68	4	67	4
							

1

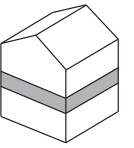

129

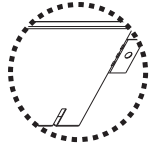

x2

411



x3

412



x3

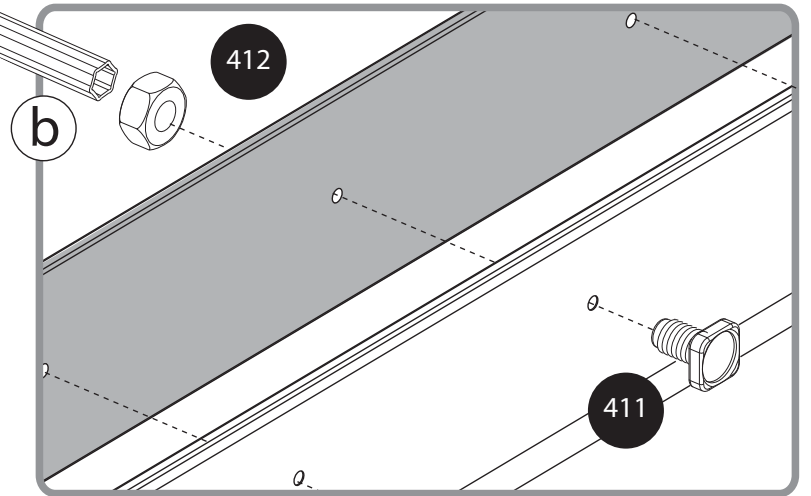
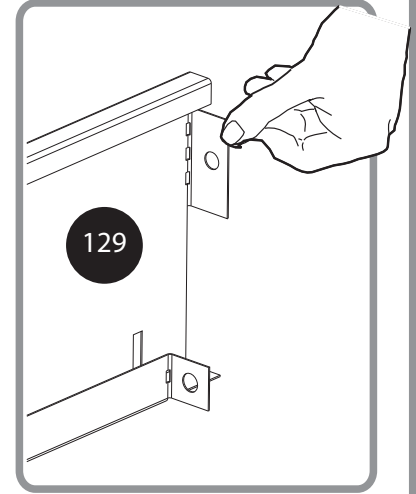
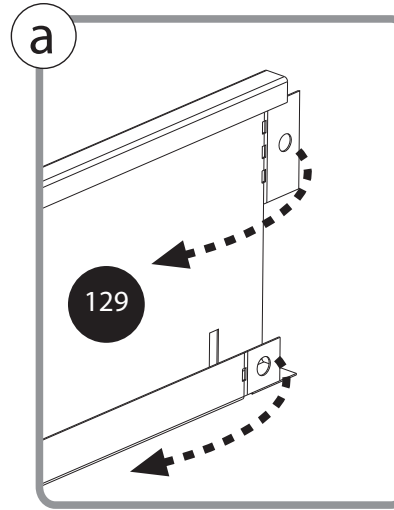
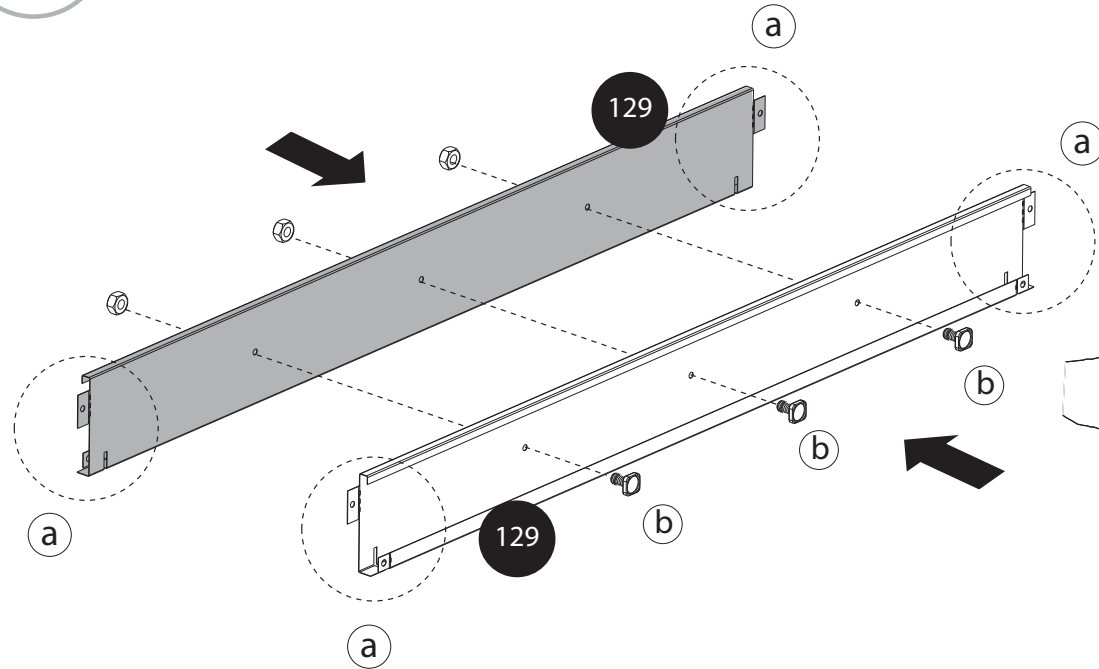
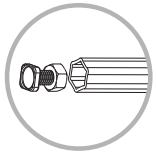

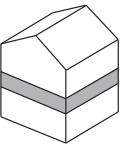

127

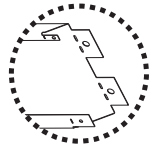
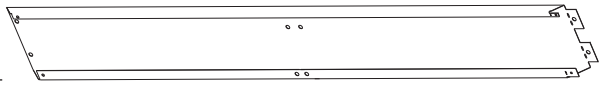

x2

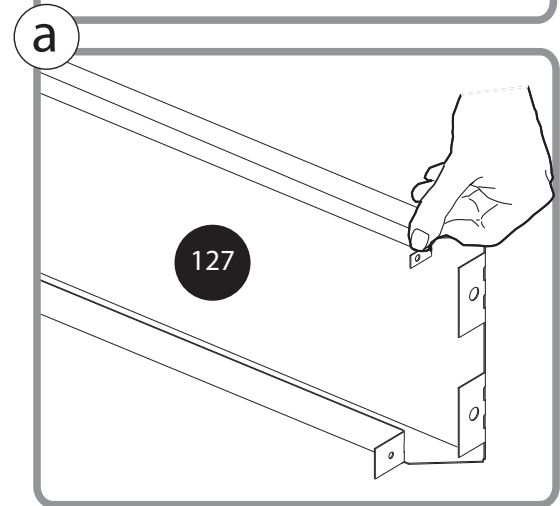
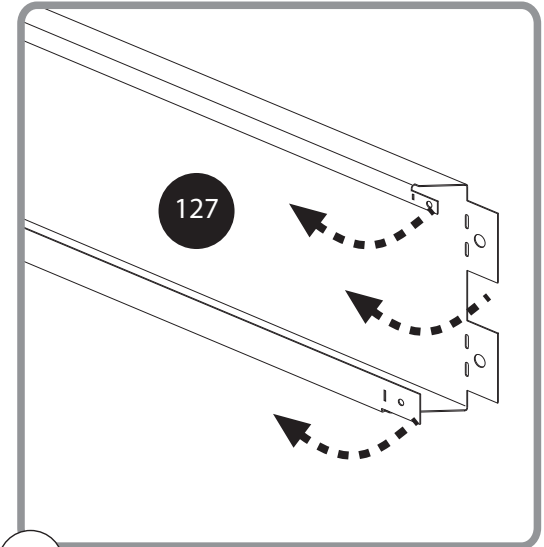
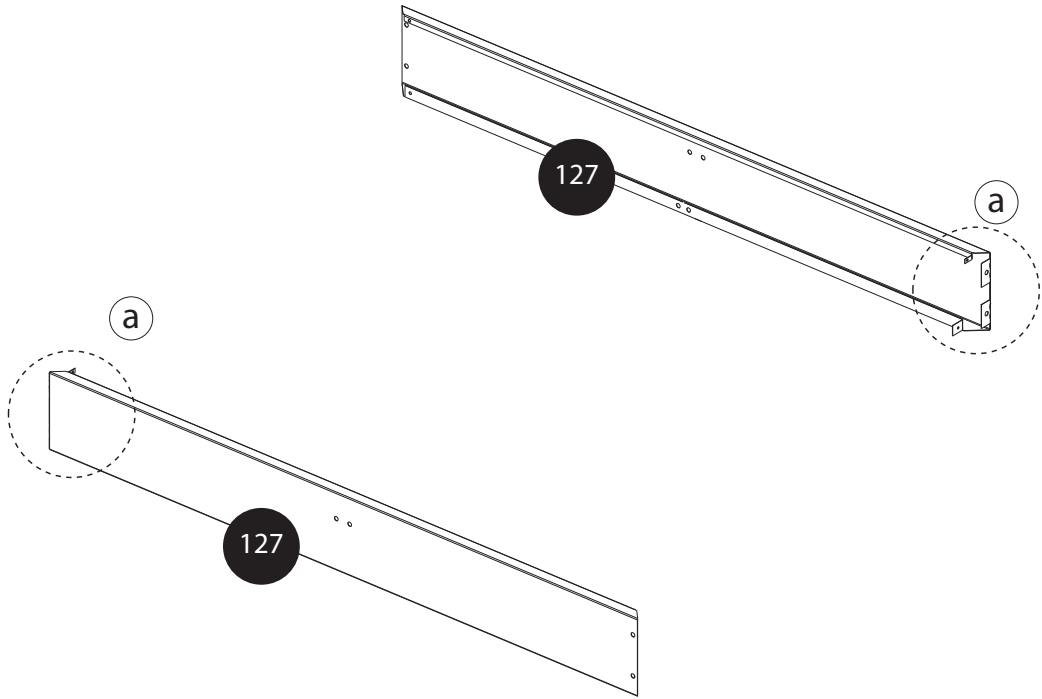

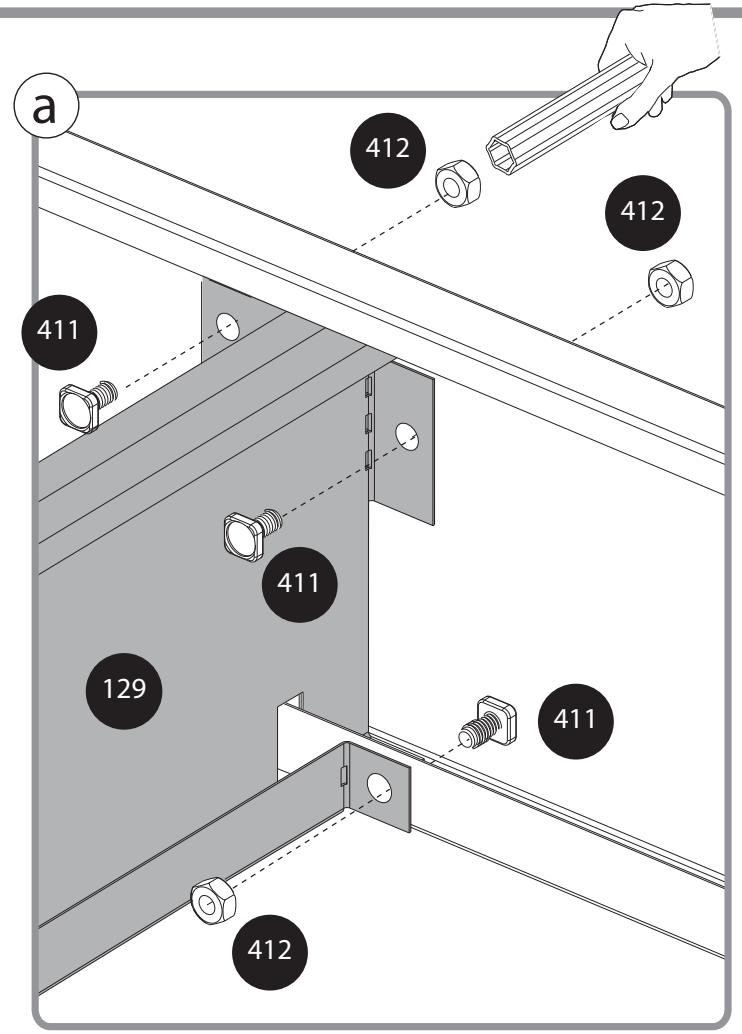
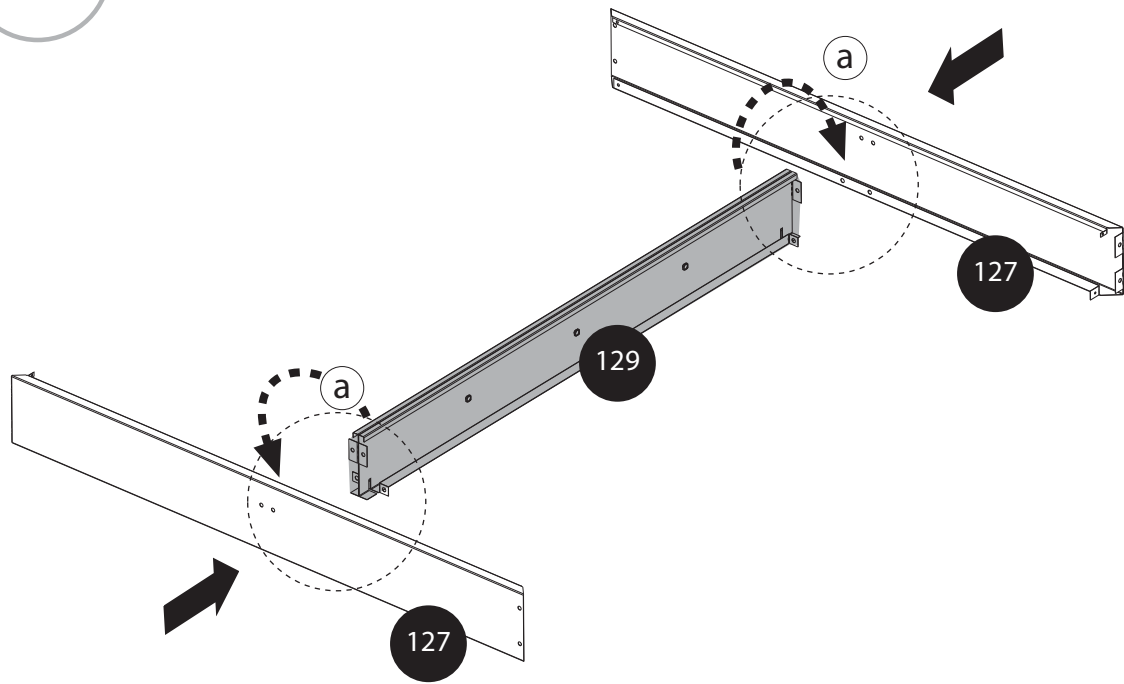
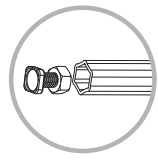
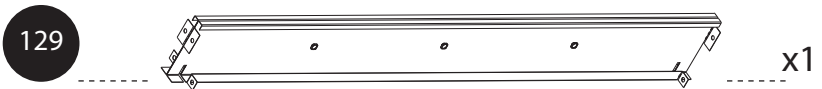
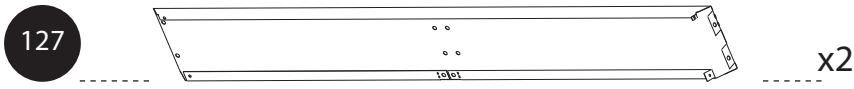
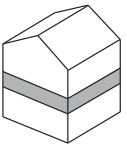

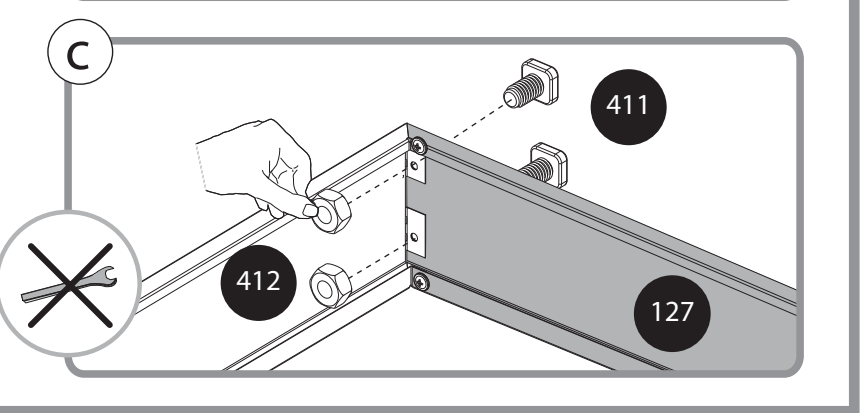
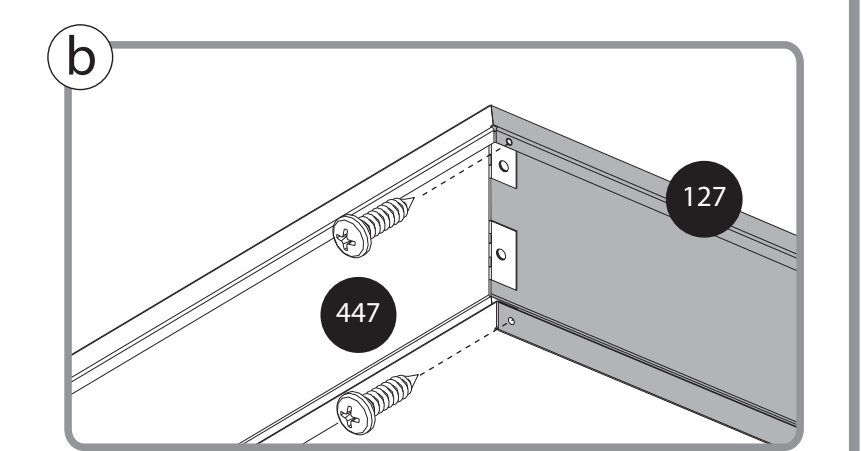
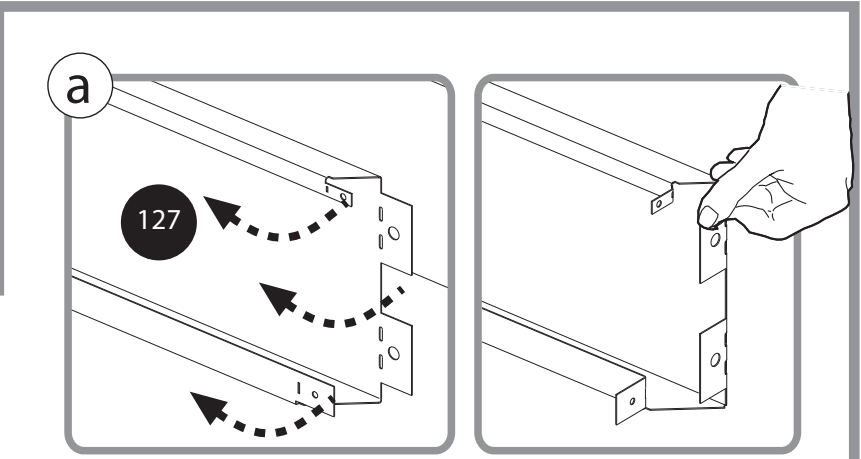
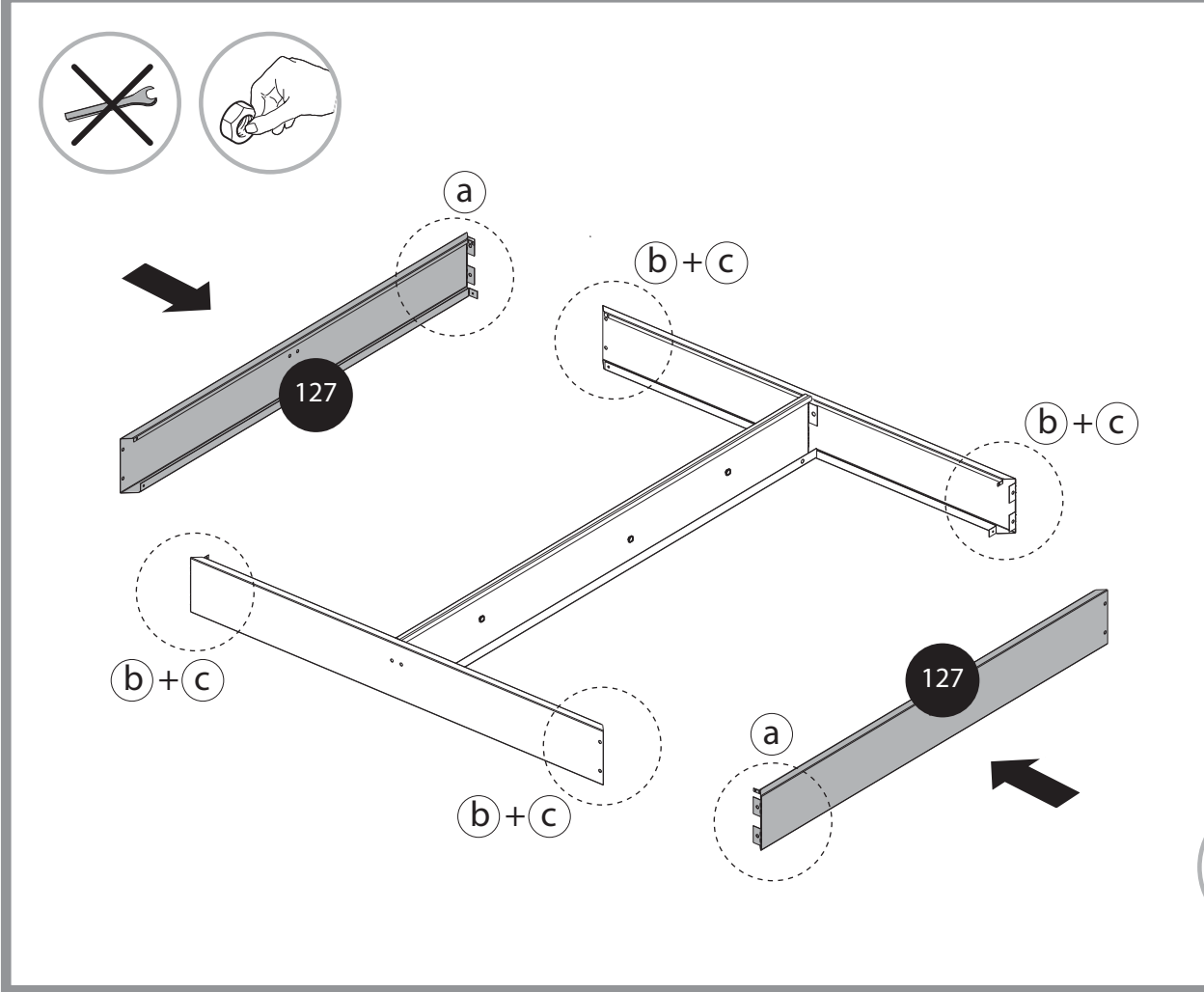
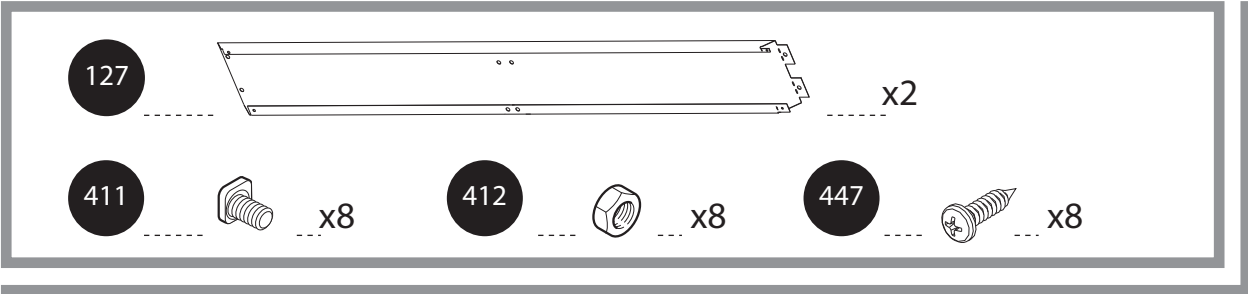
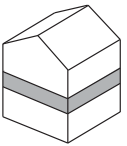

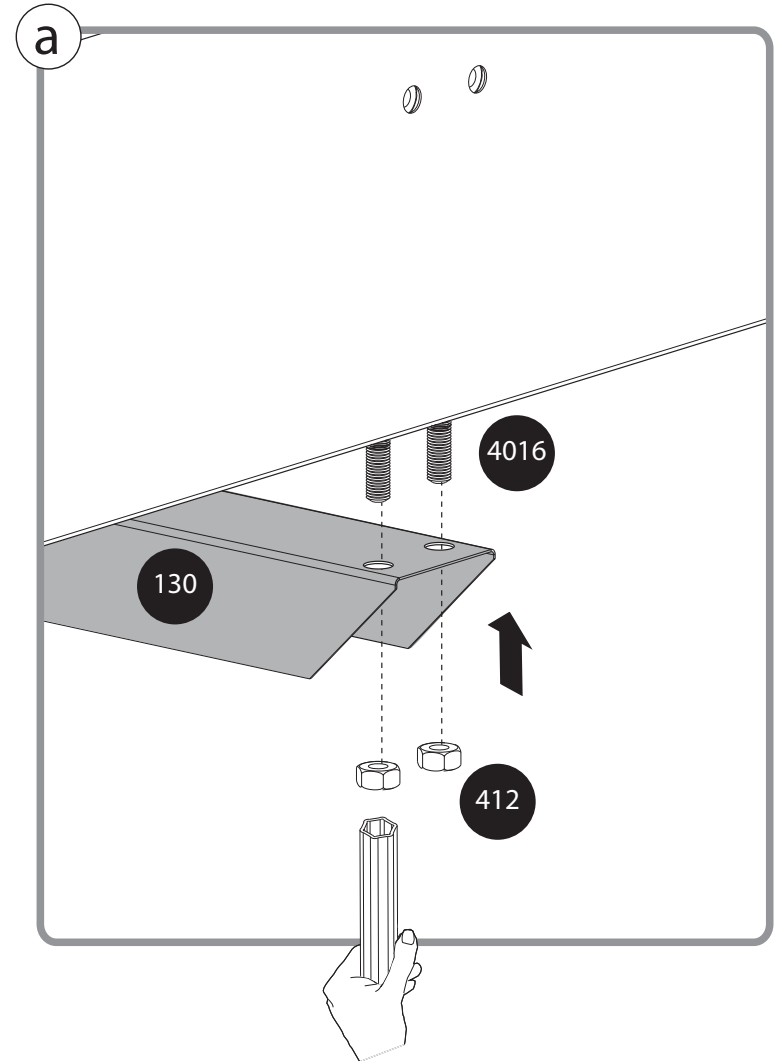
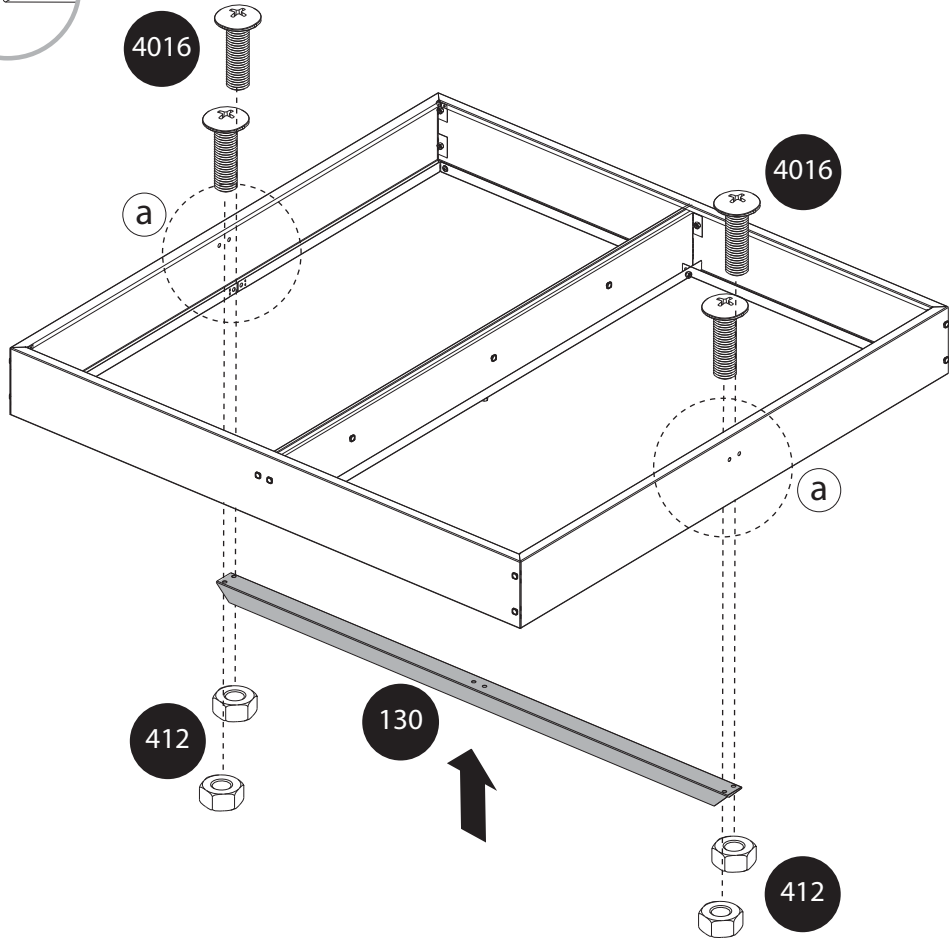
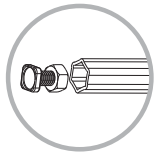
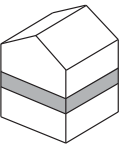

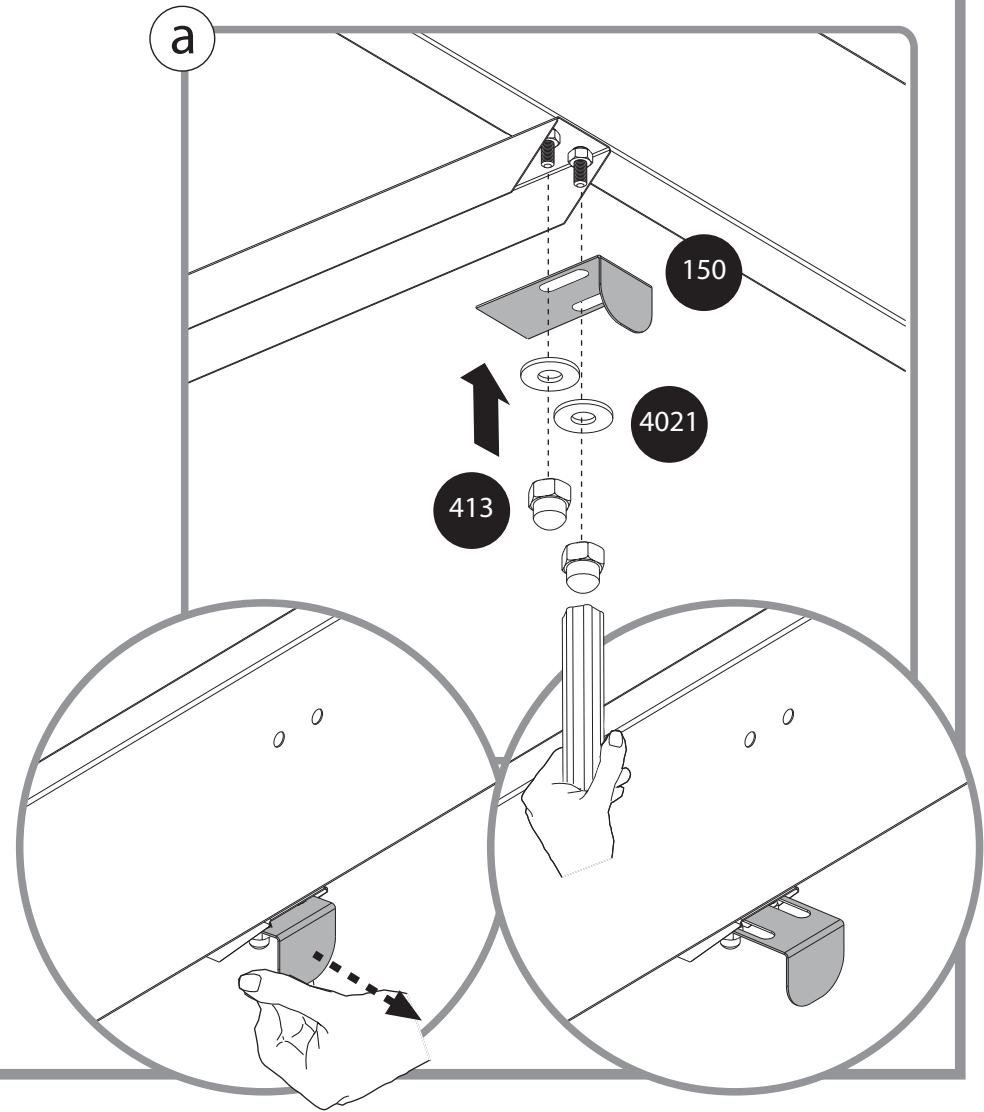
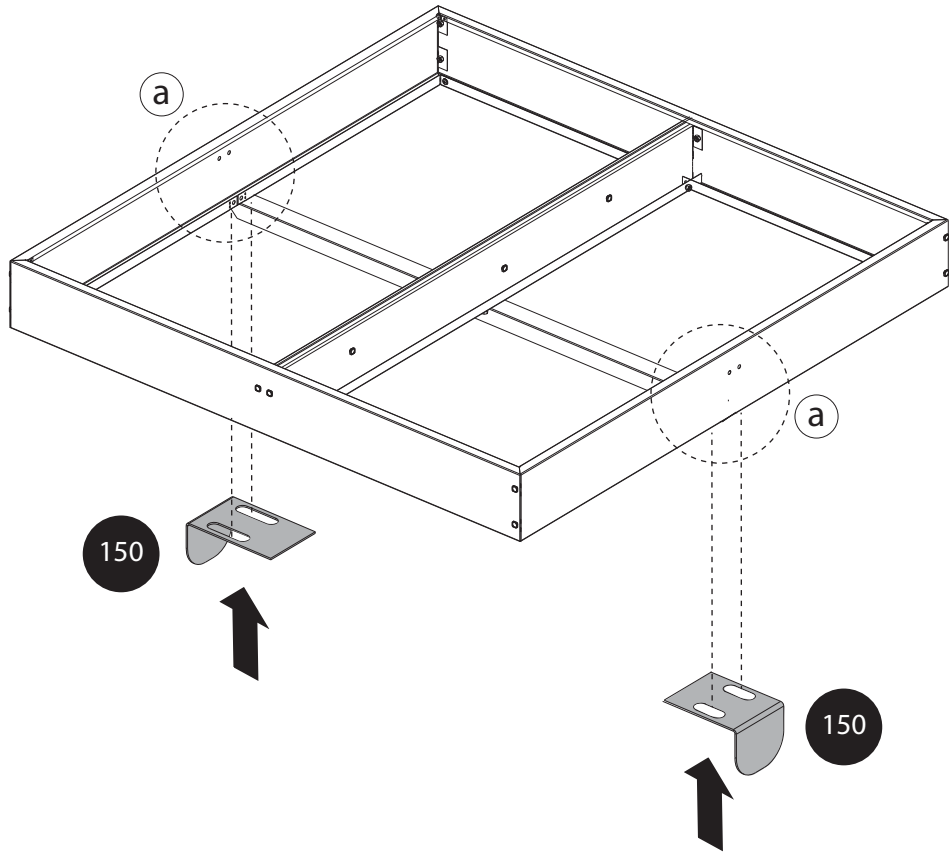
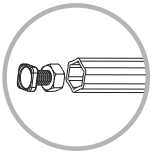
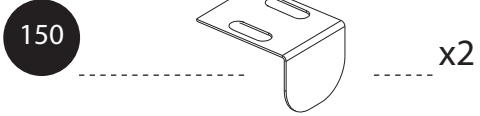
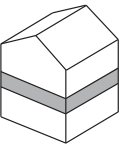

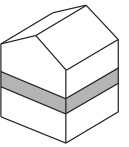



411  x6 412  x6

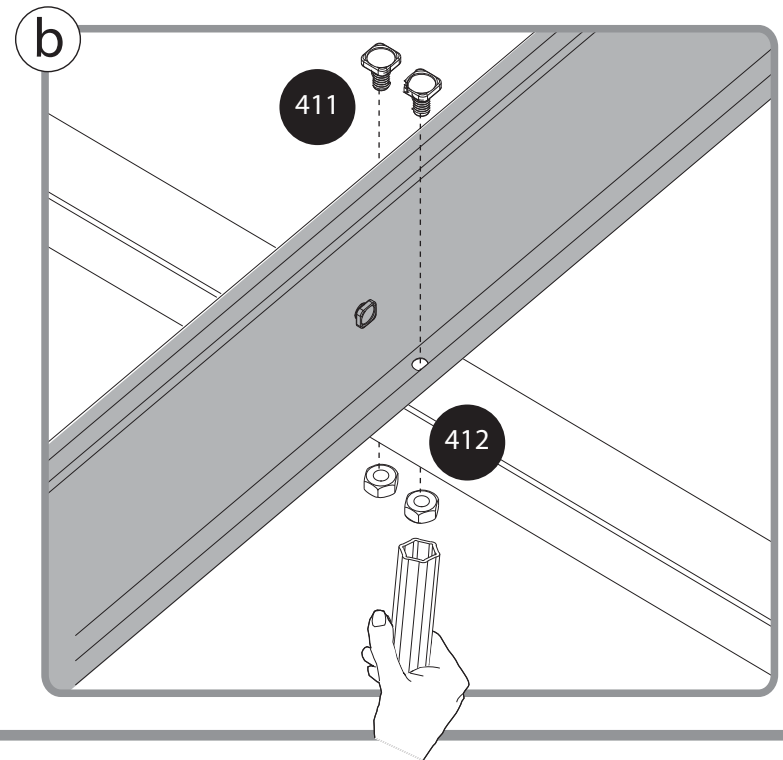
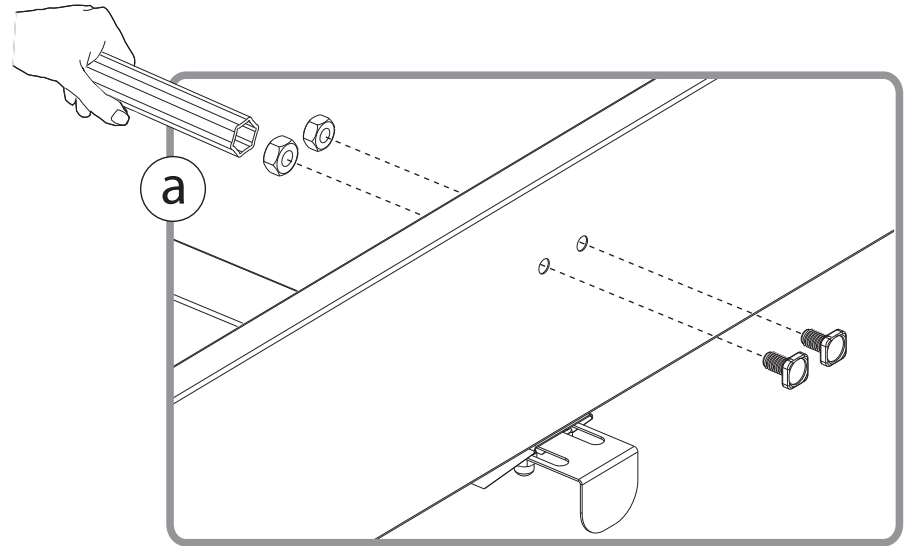
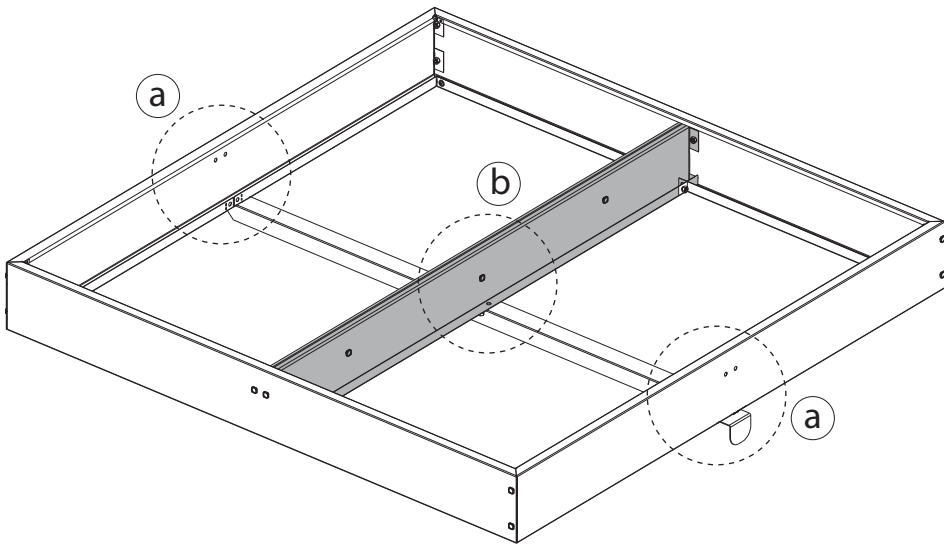
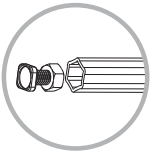

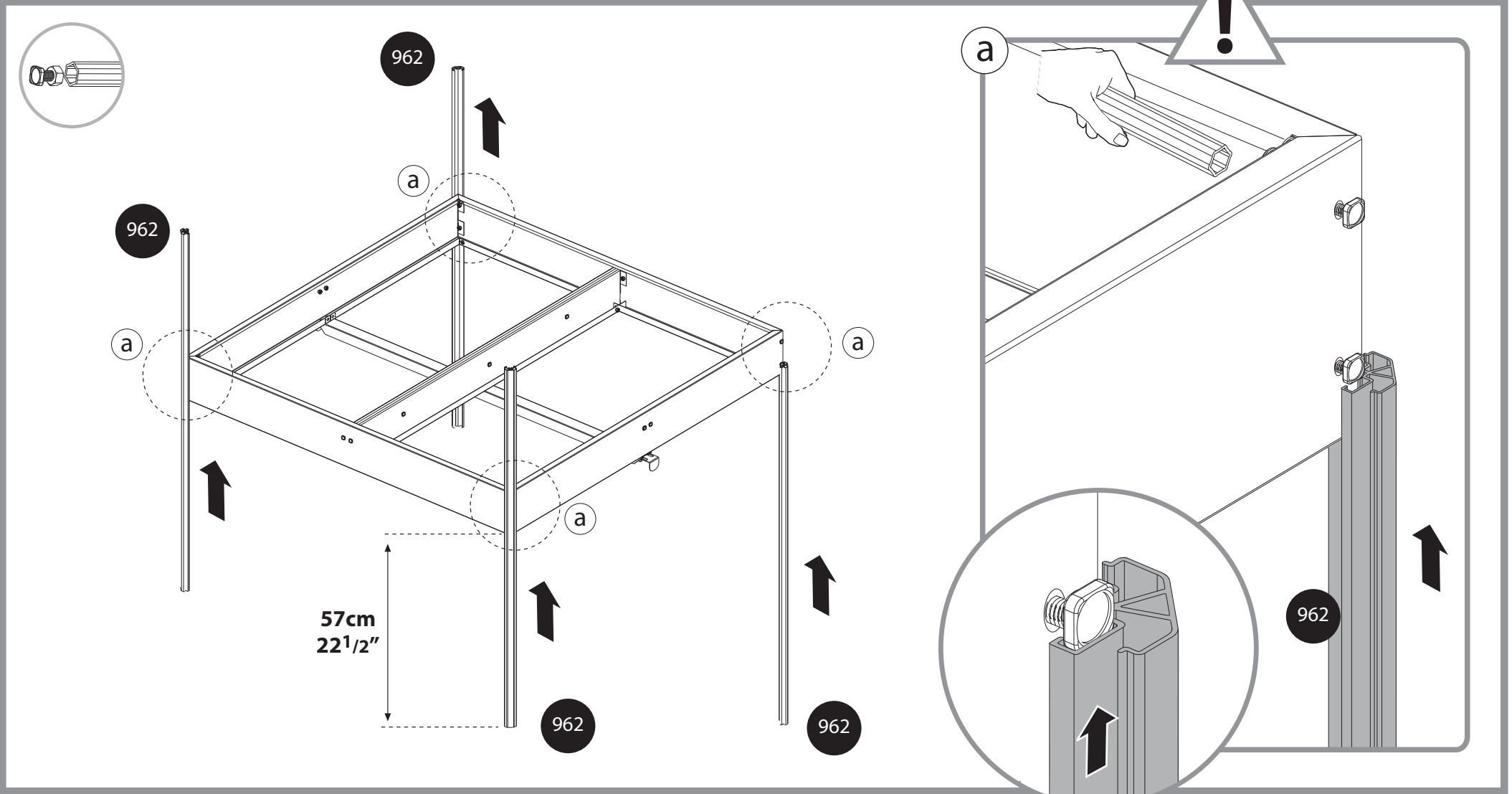
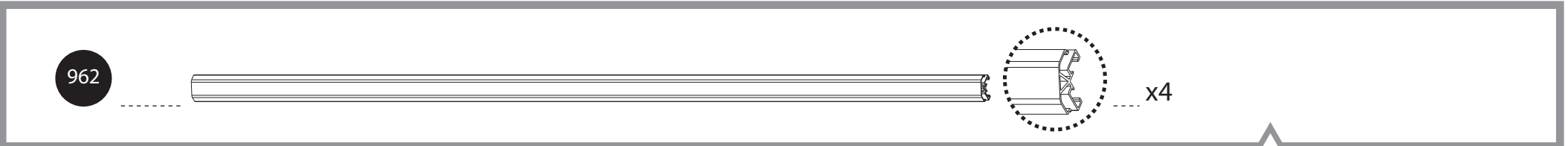
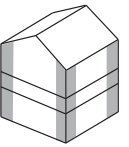

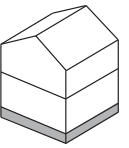

128x4

412x8

411x8

447x4

a + b

128

128

128

128

a + b

a

b

412

411

447

128

411

447

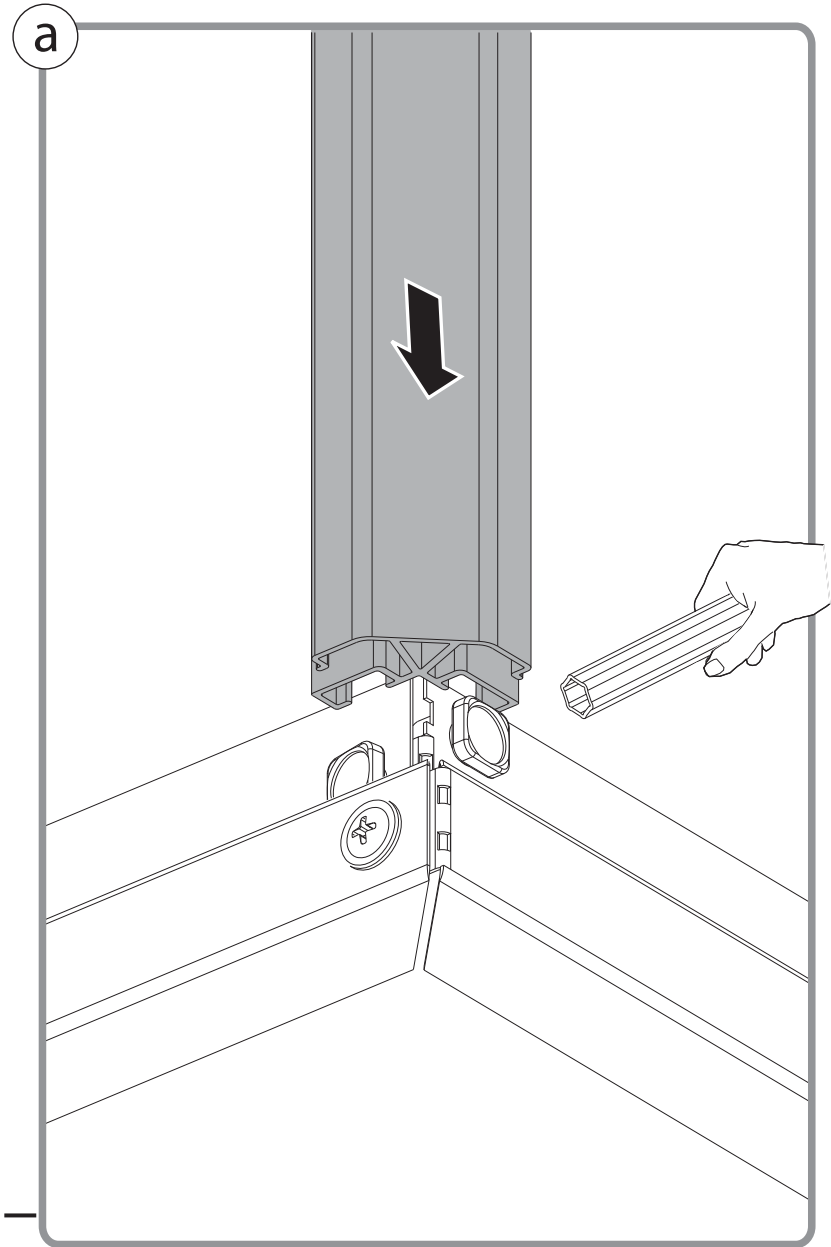
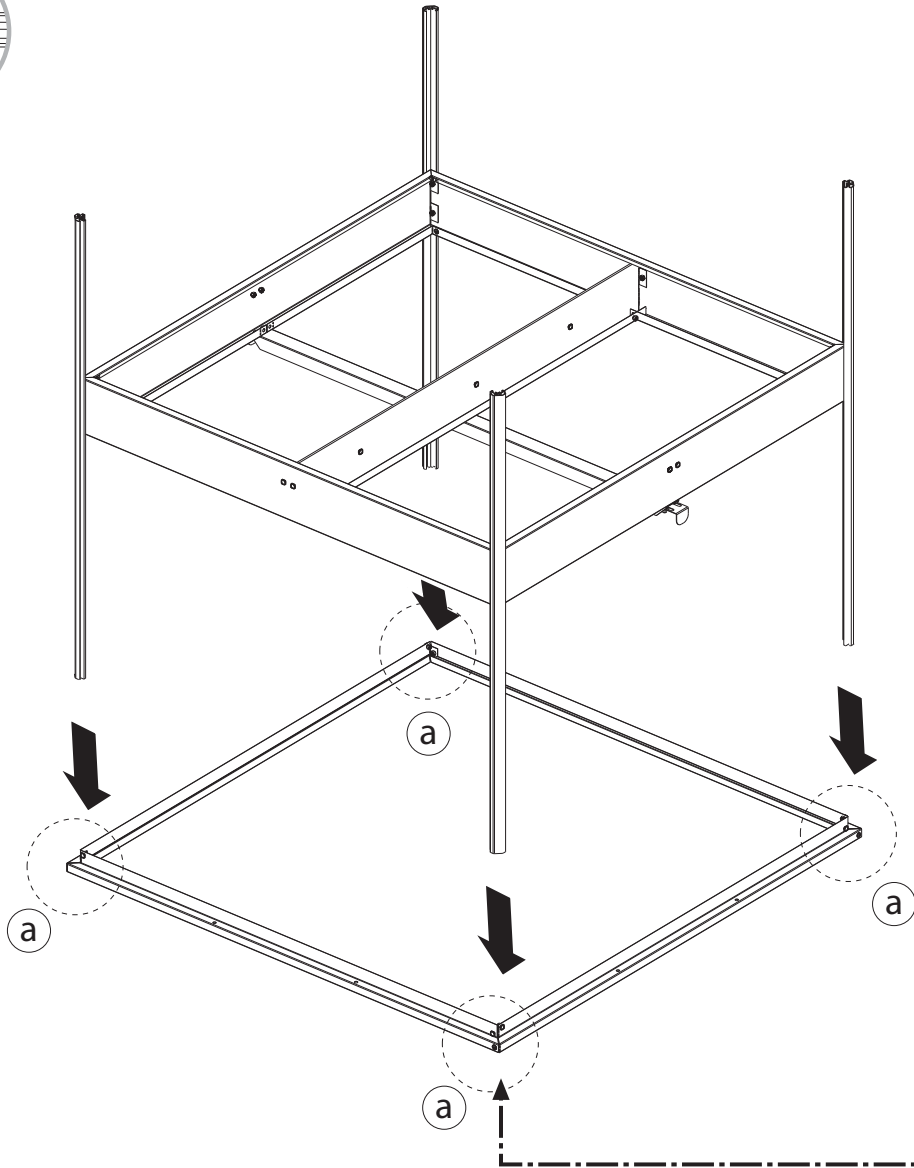
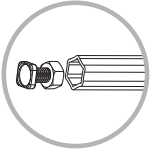
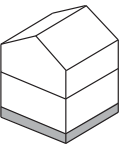

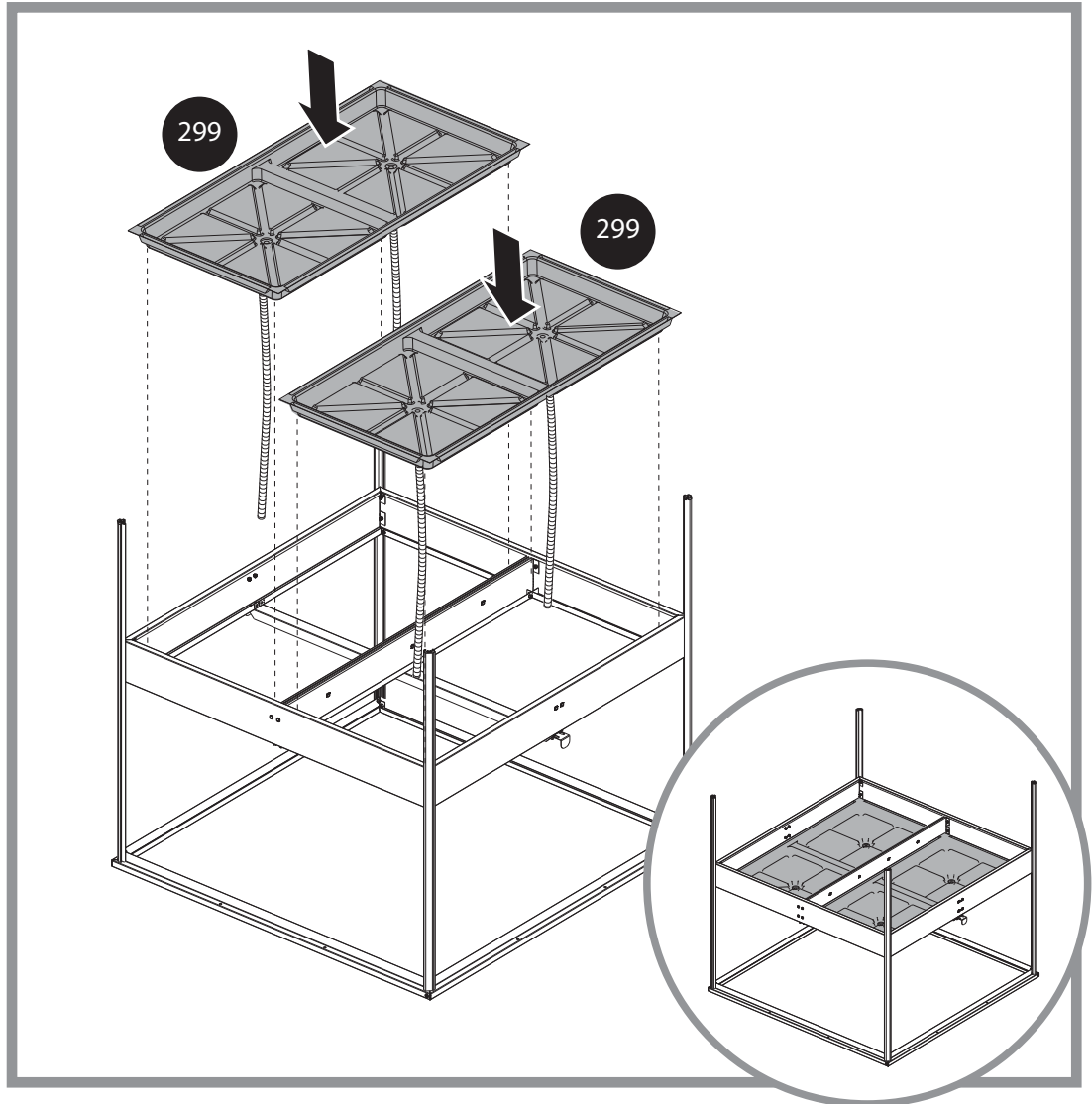
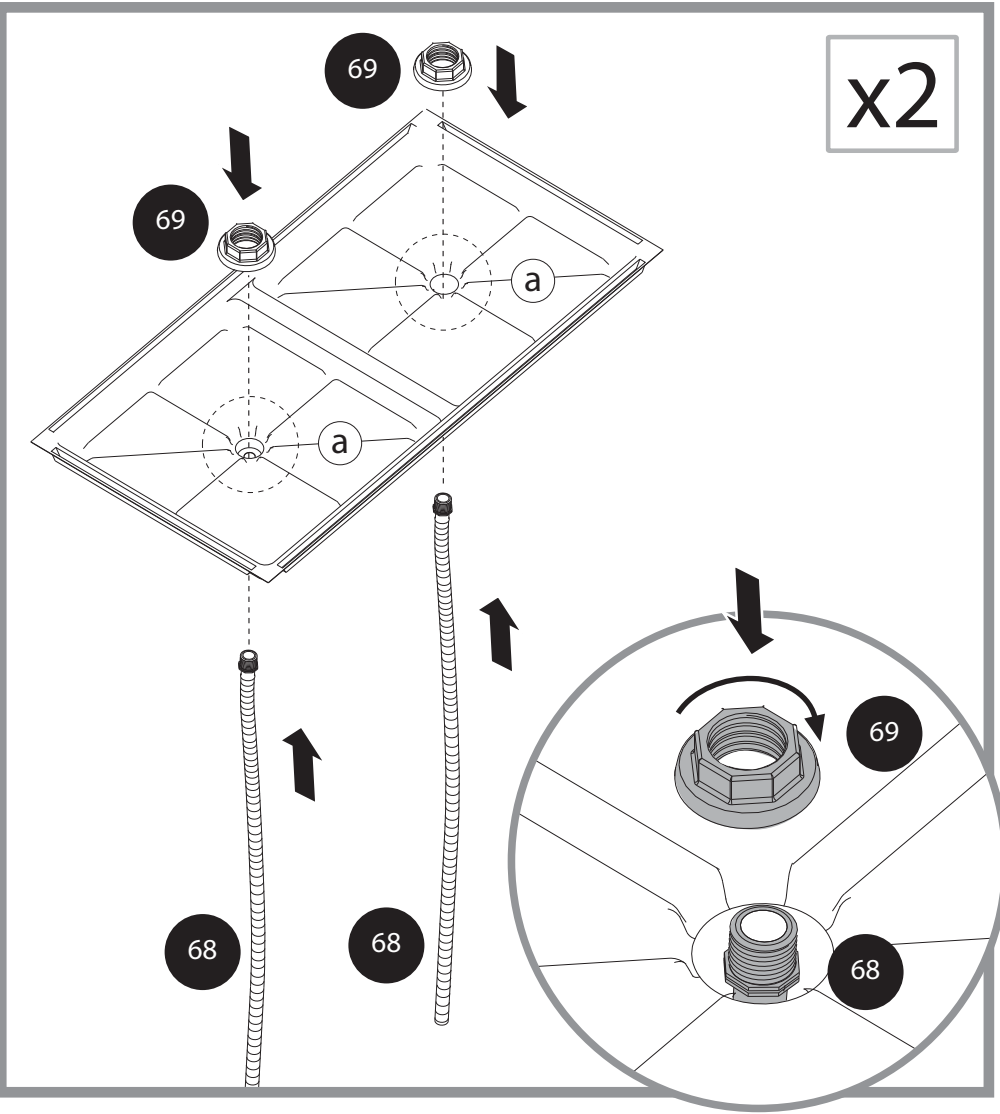
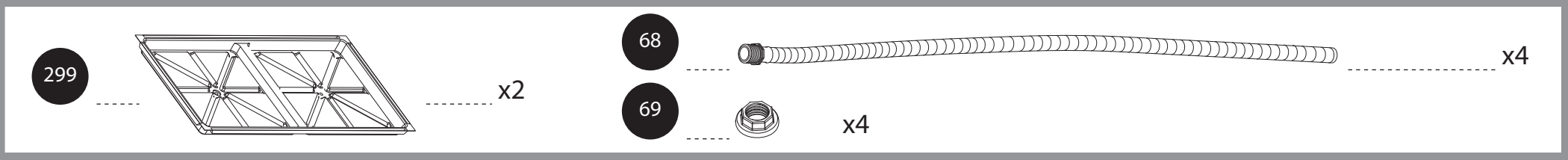
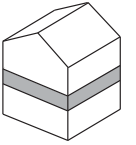

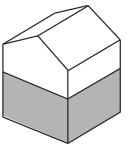

298

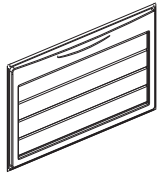

x4

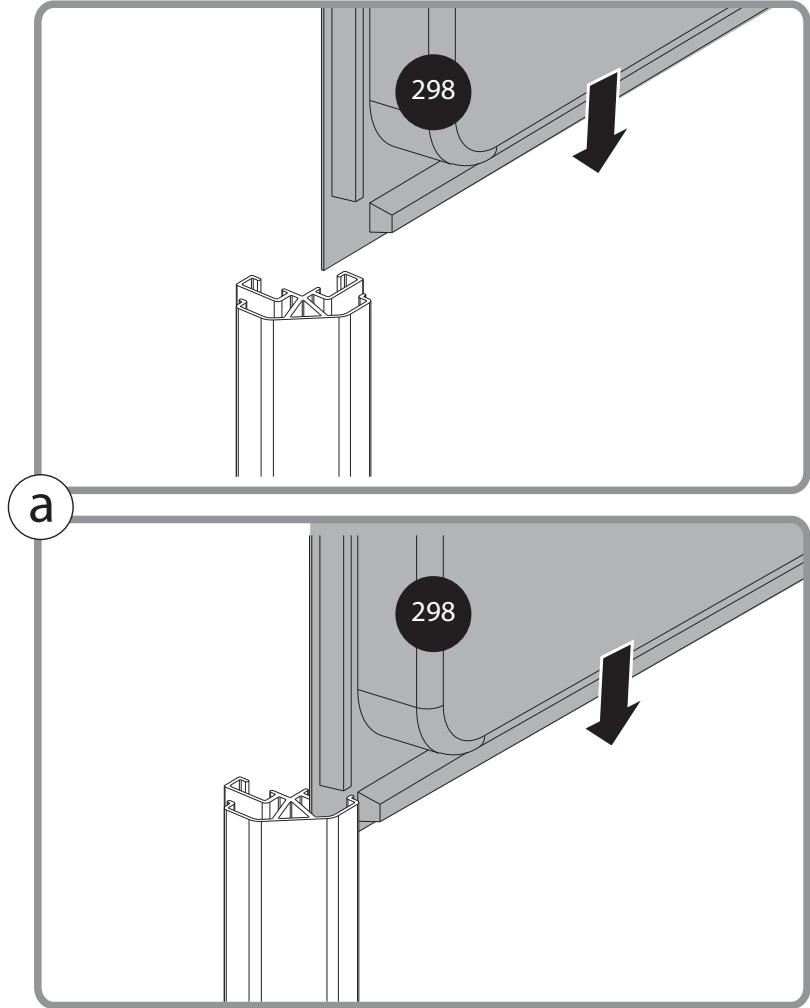
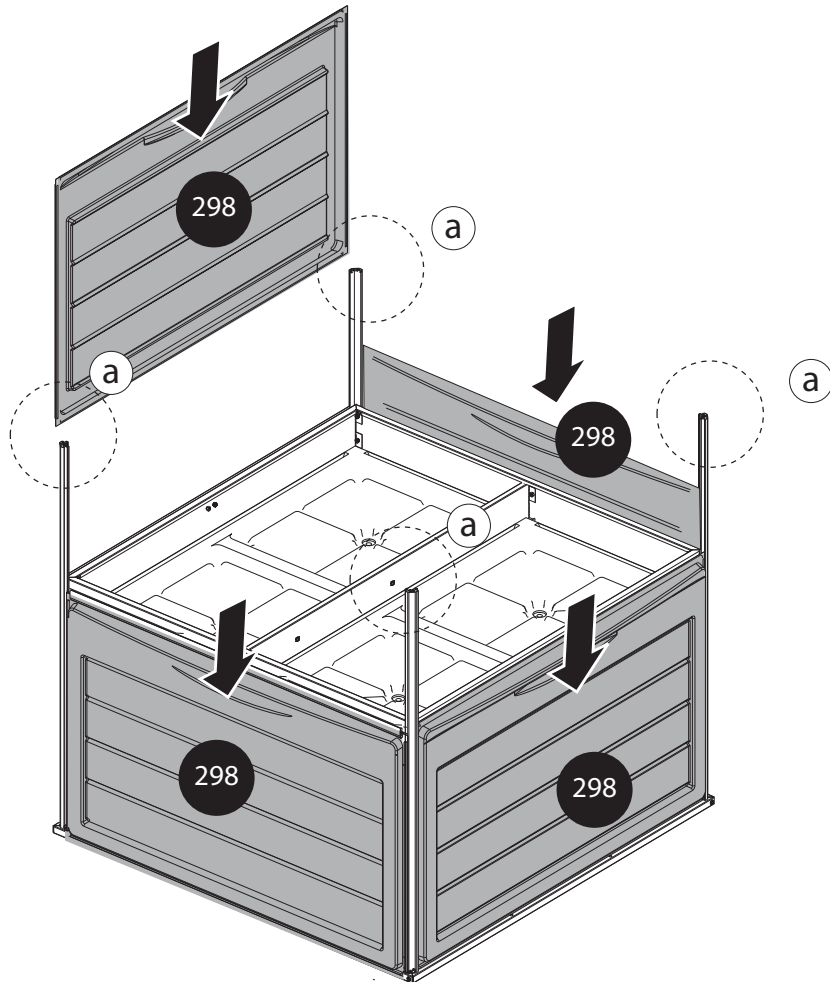

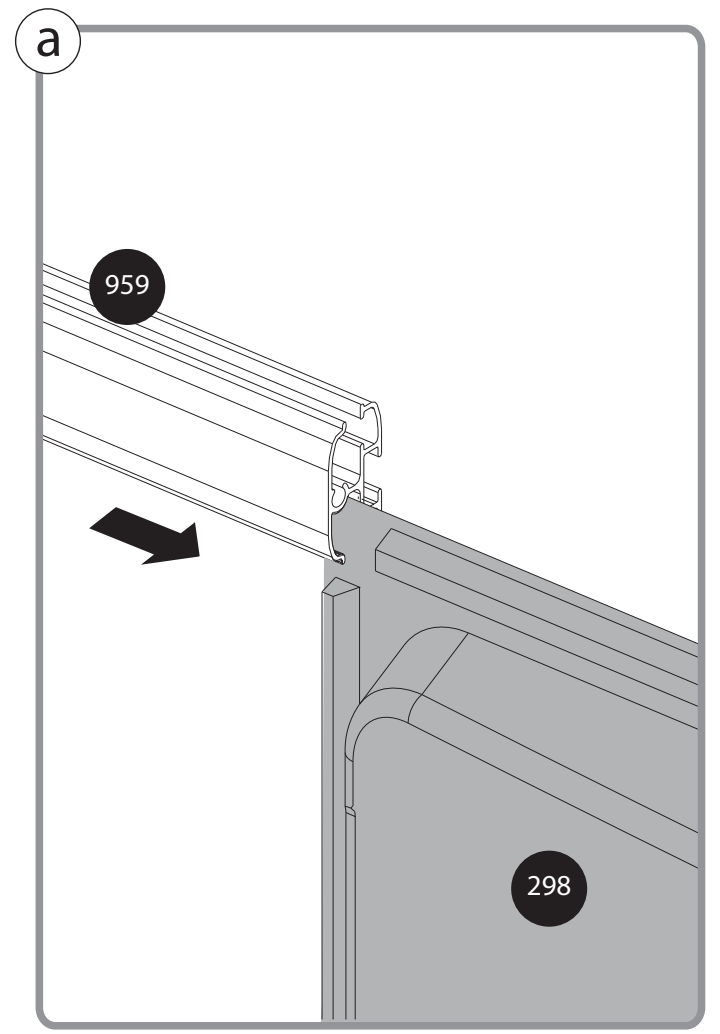
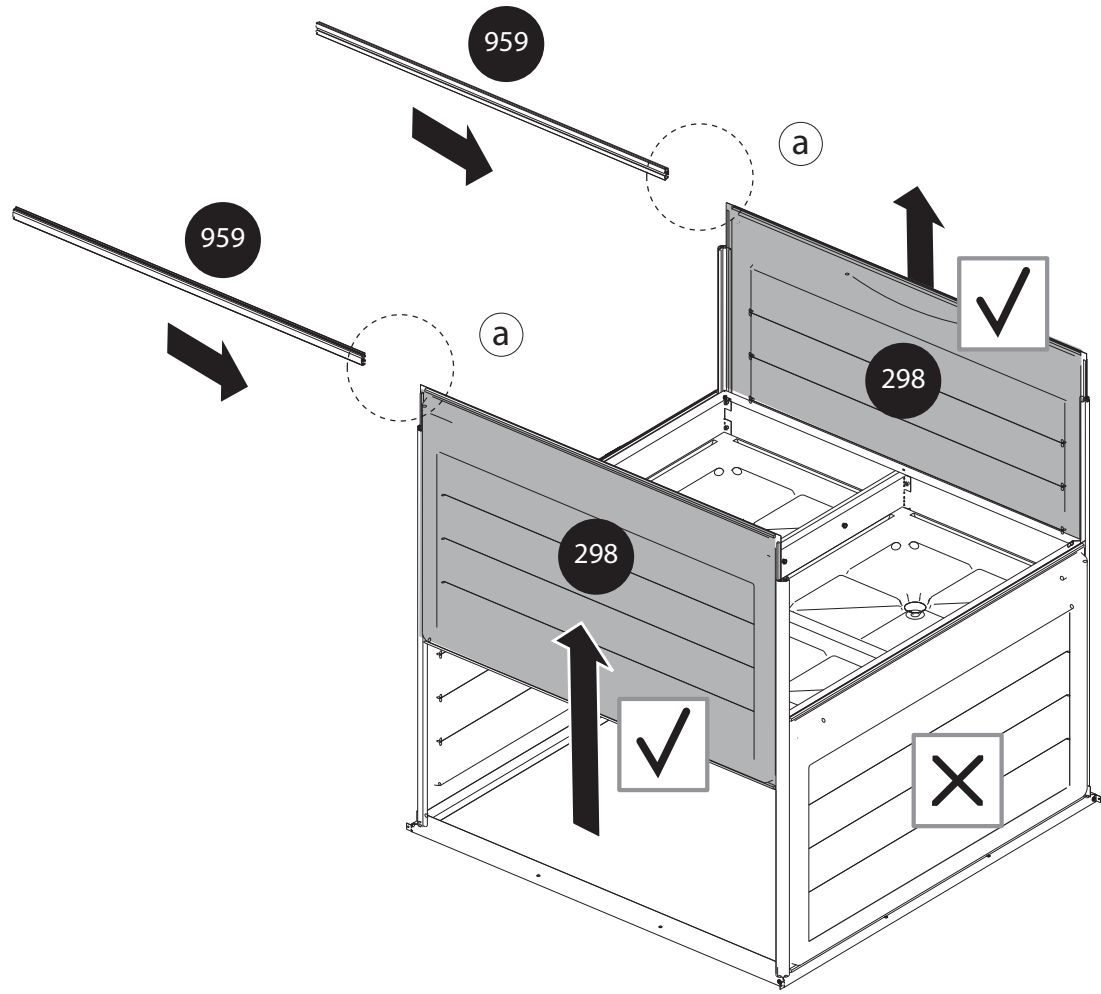
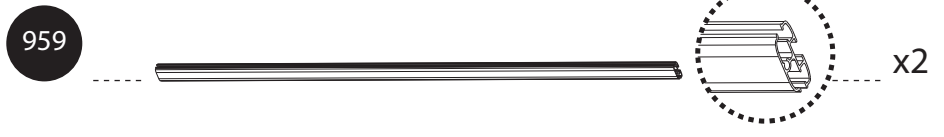
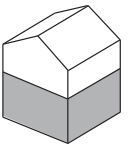

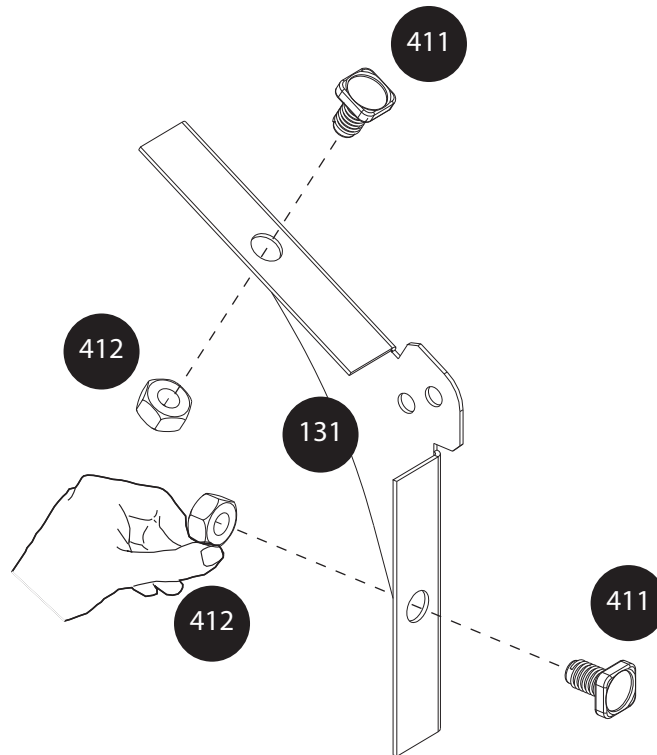
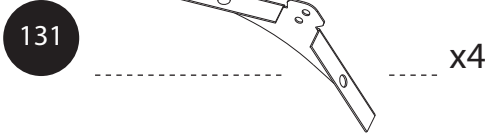
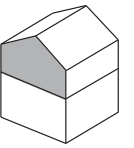

x4

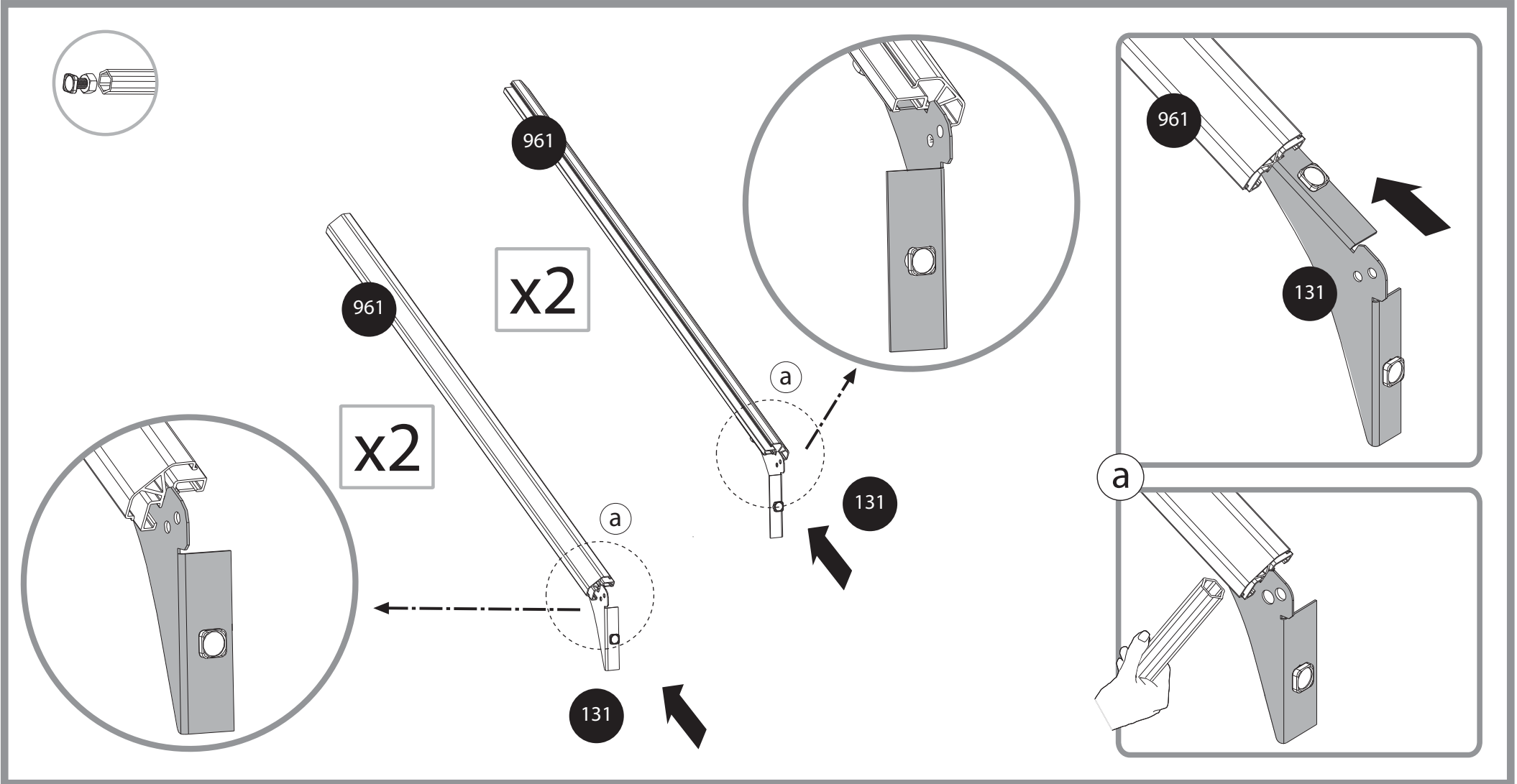
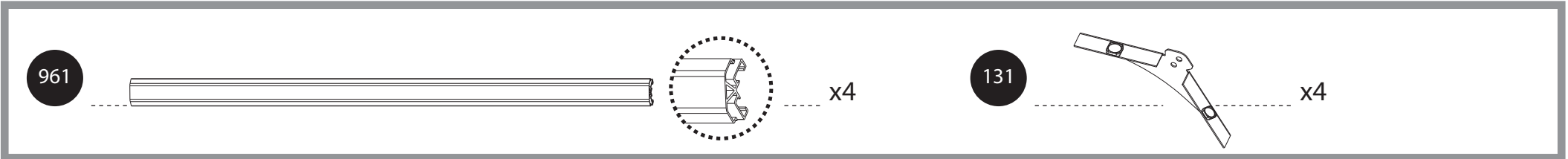
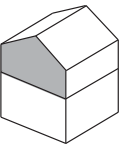

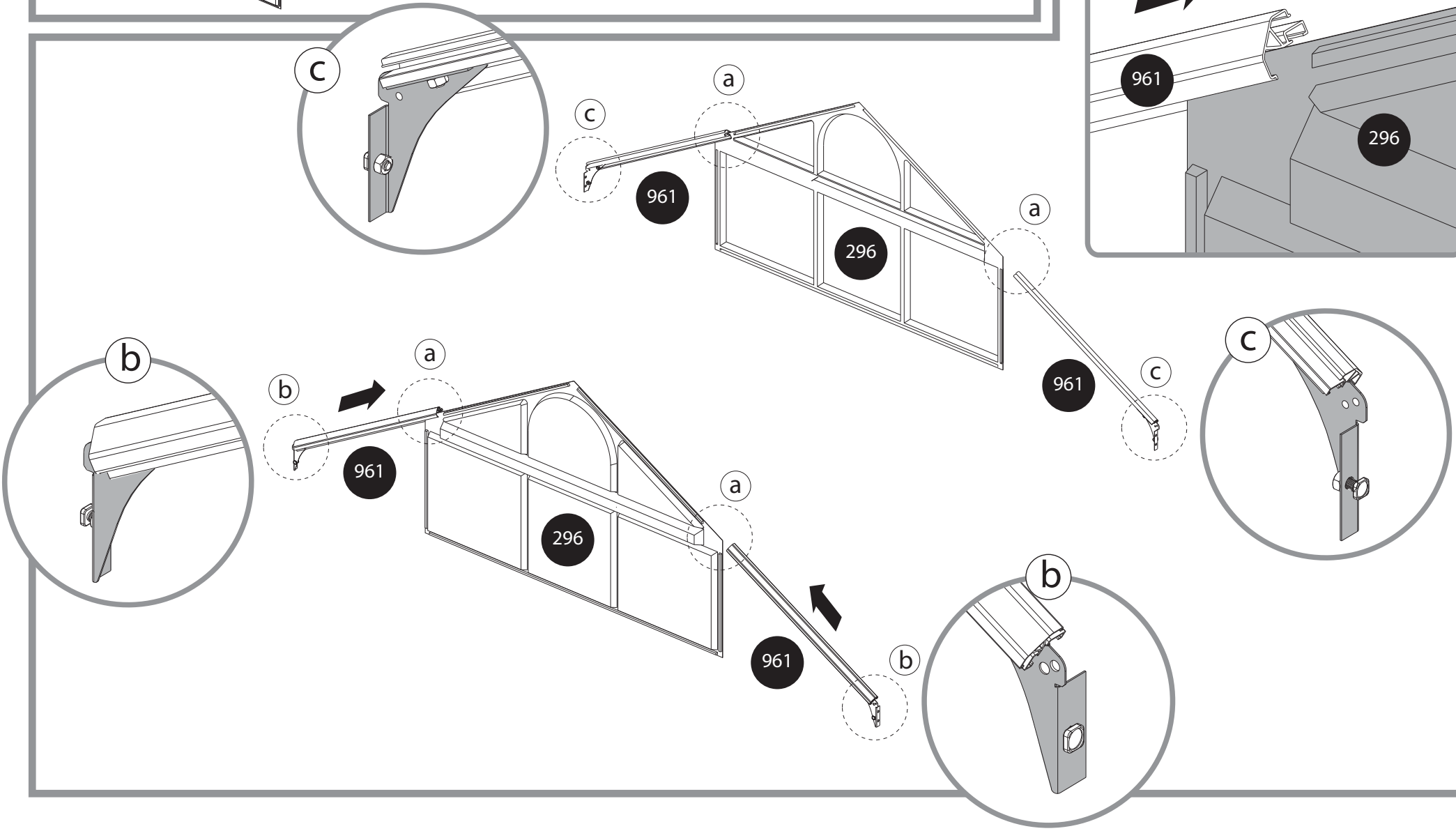
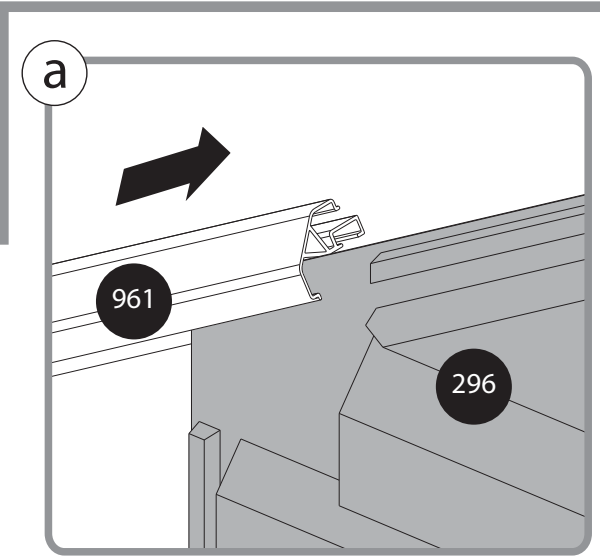
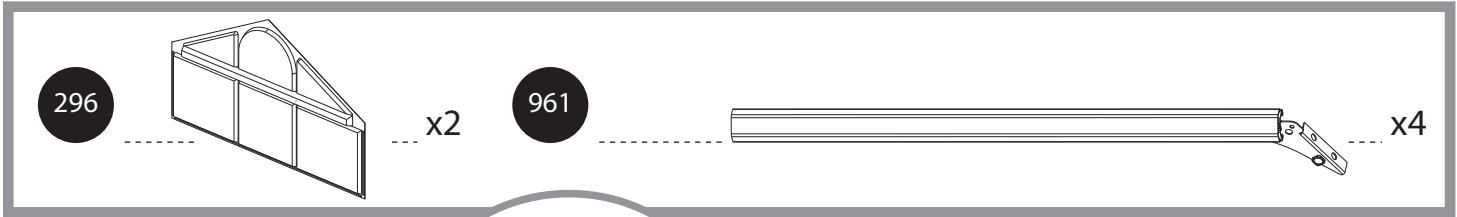
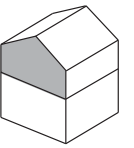

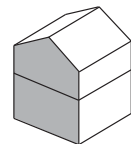

296

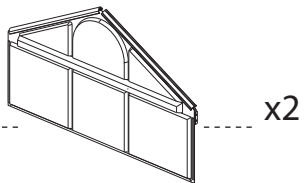

x2

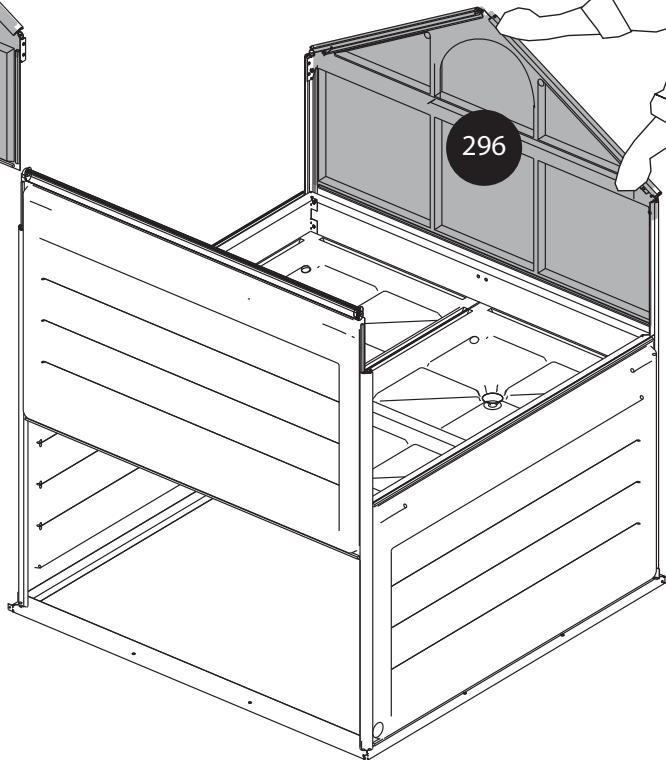
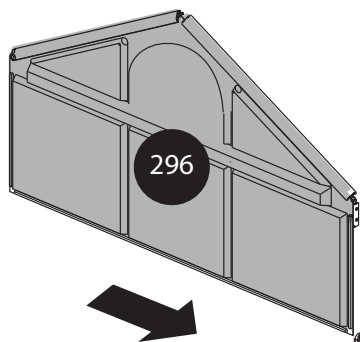

296

x2

a

296



298

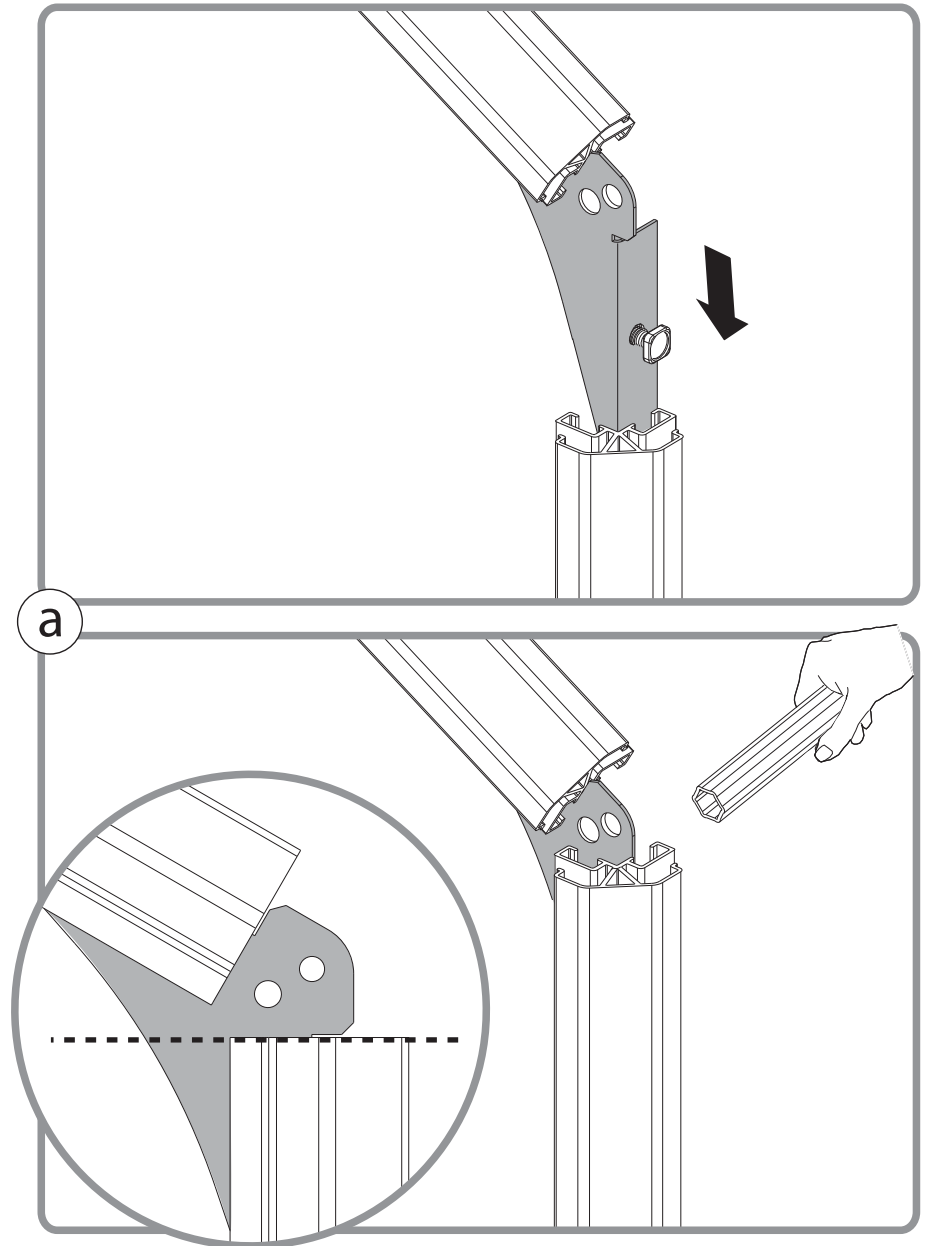
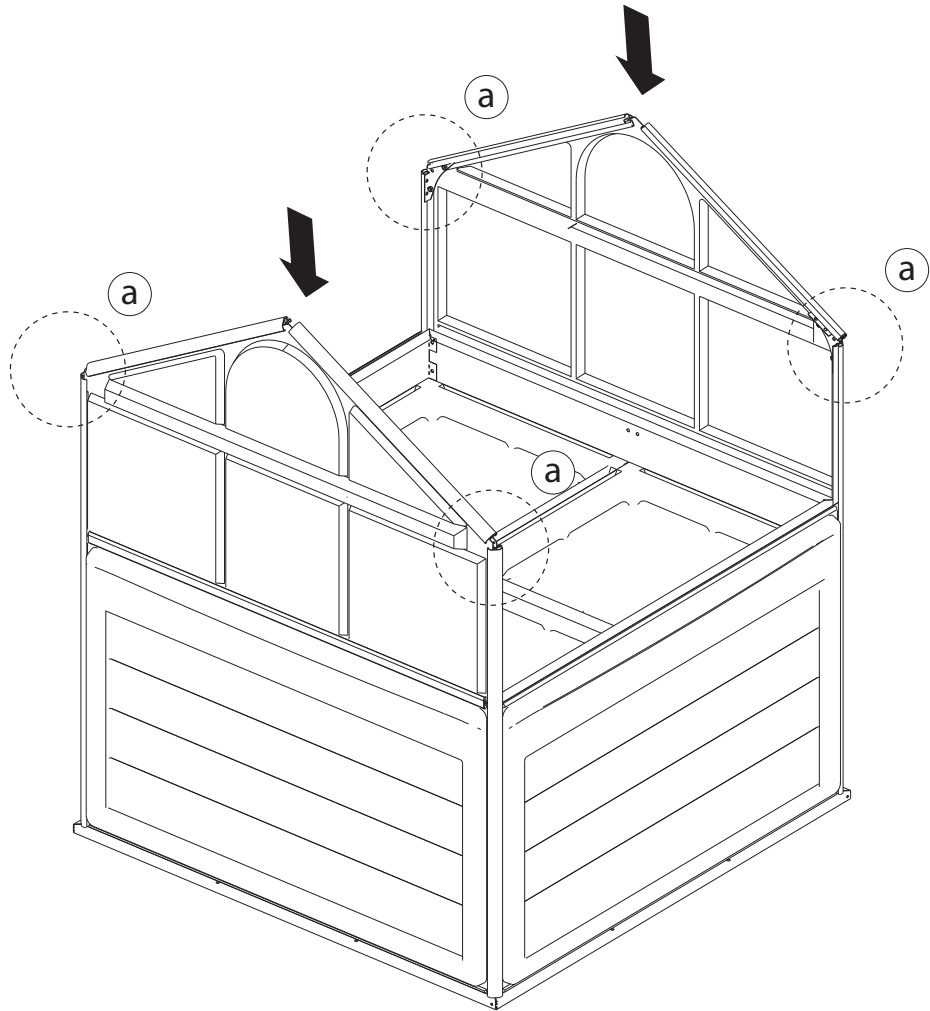
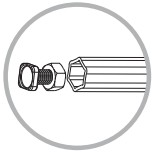
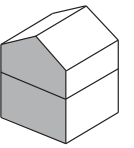

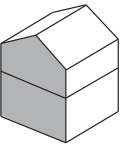

412  x8

411  x12

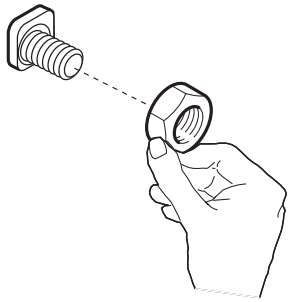
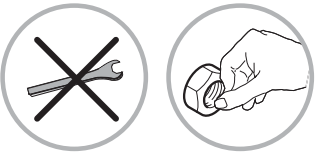

x8

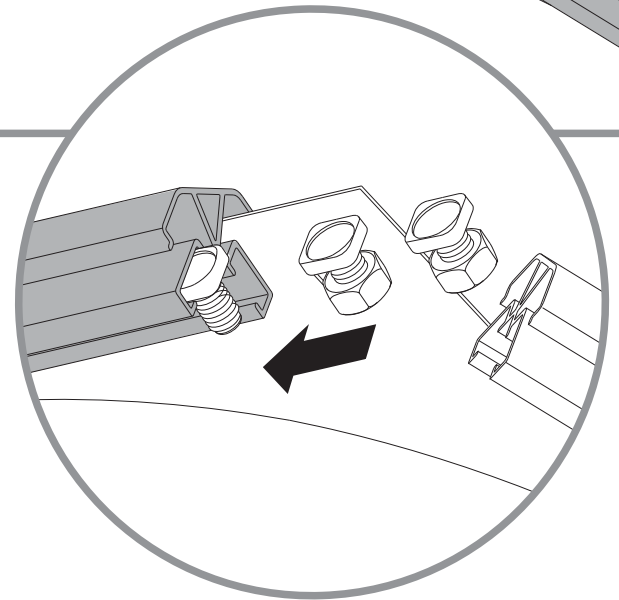
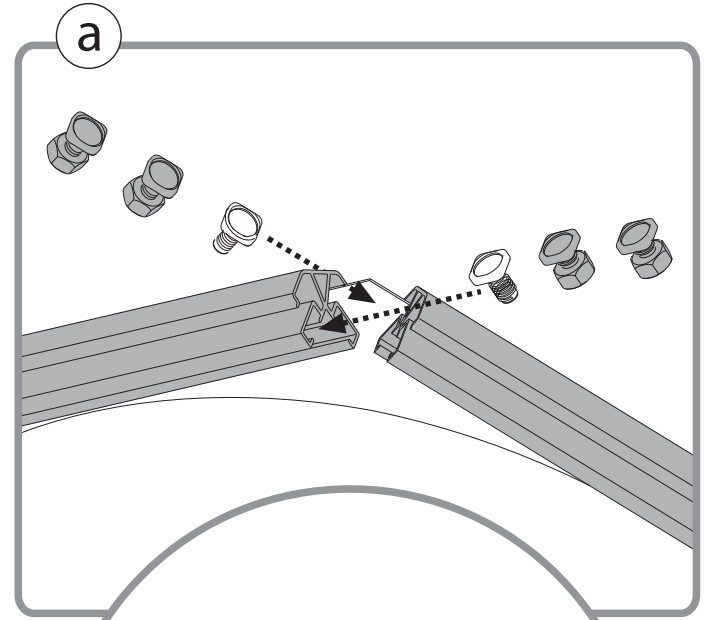
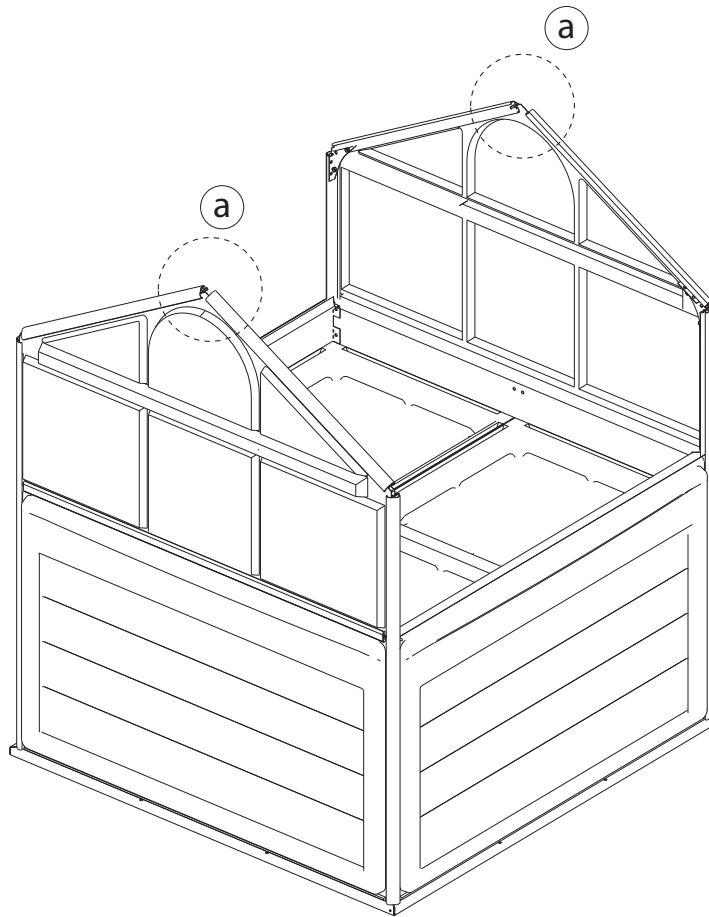

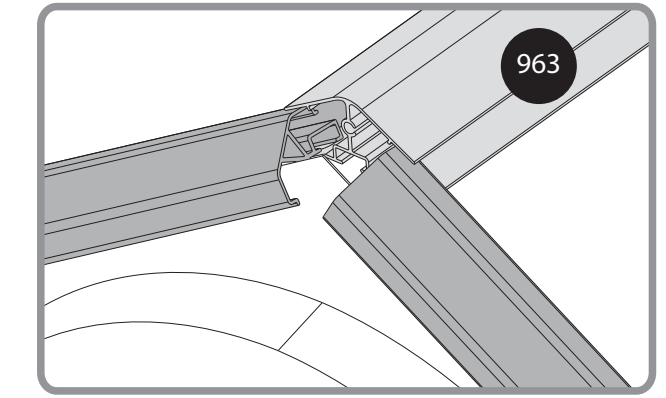
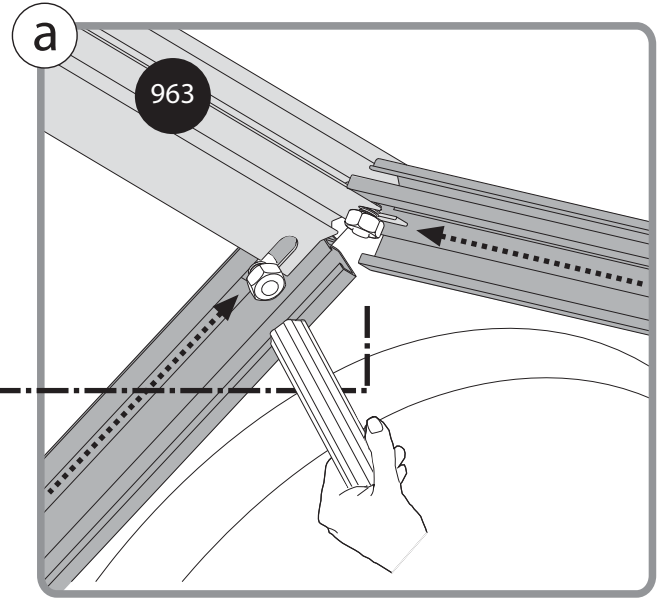
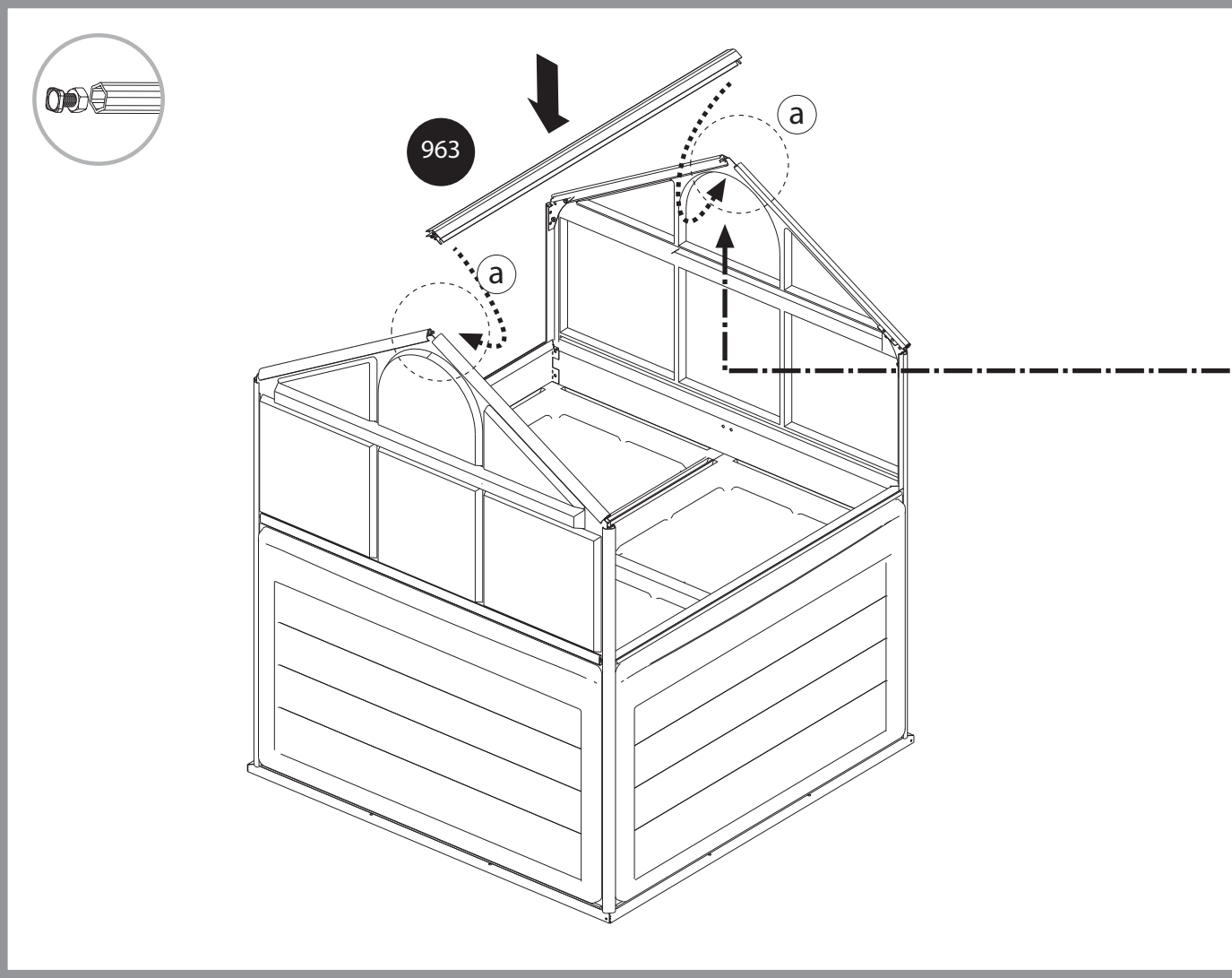
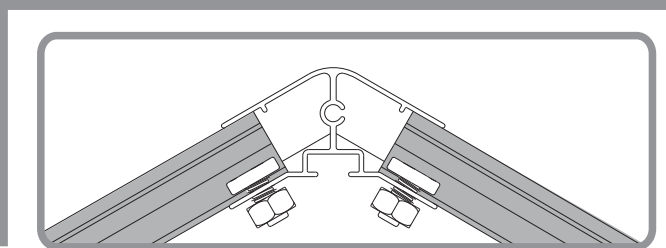
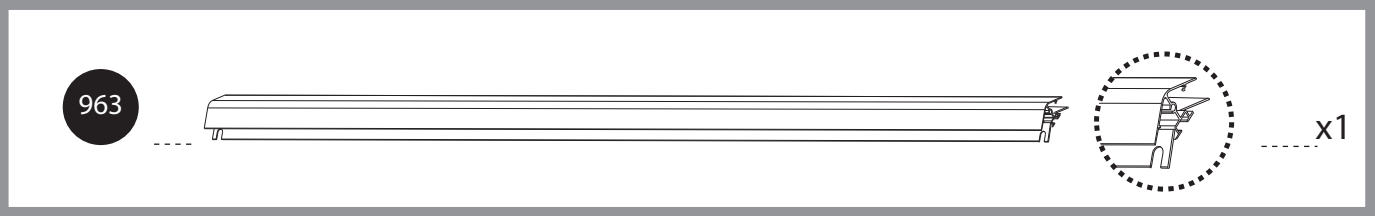
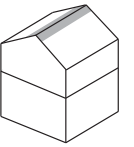

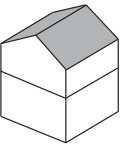

139 x4

412 x4

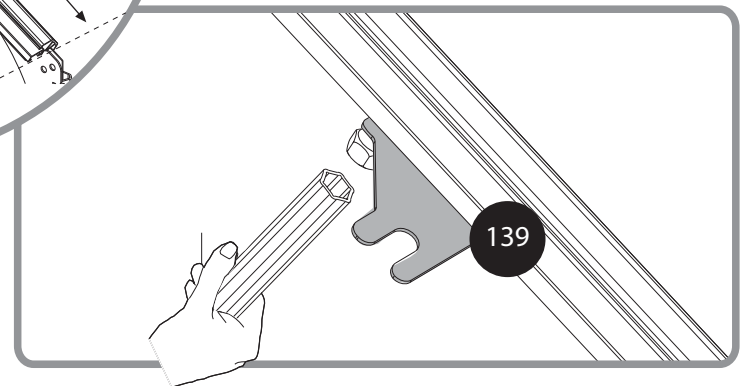
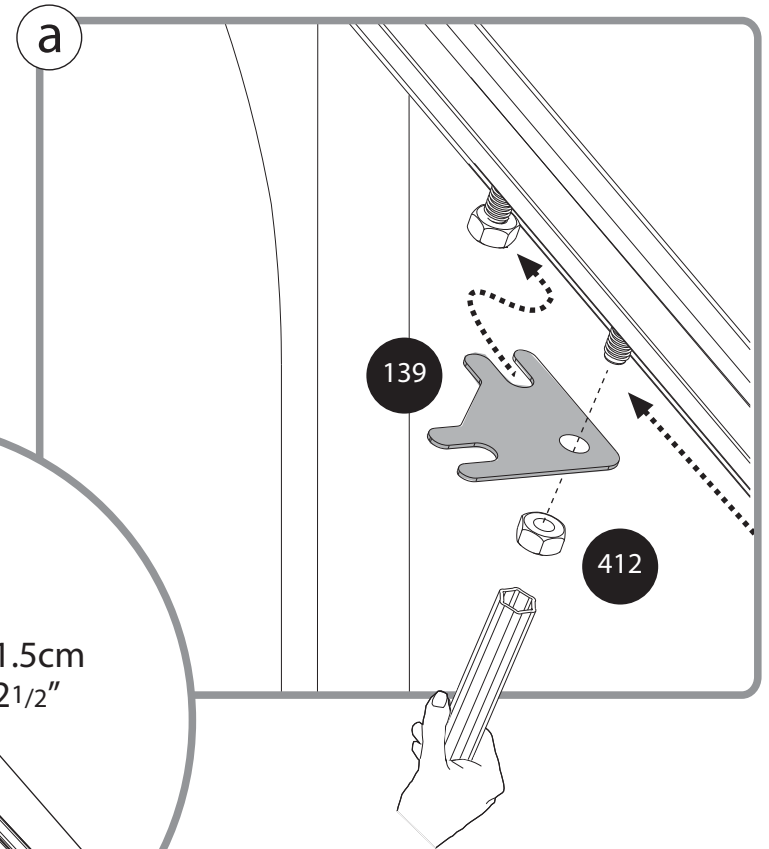
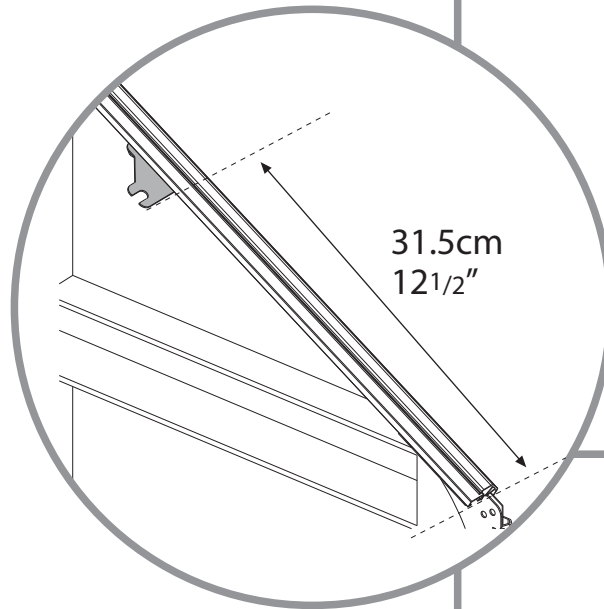
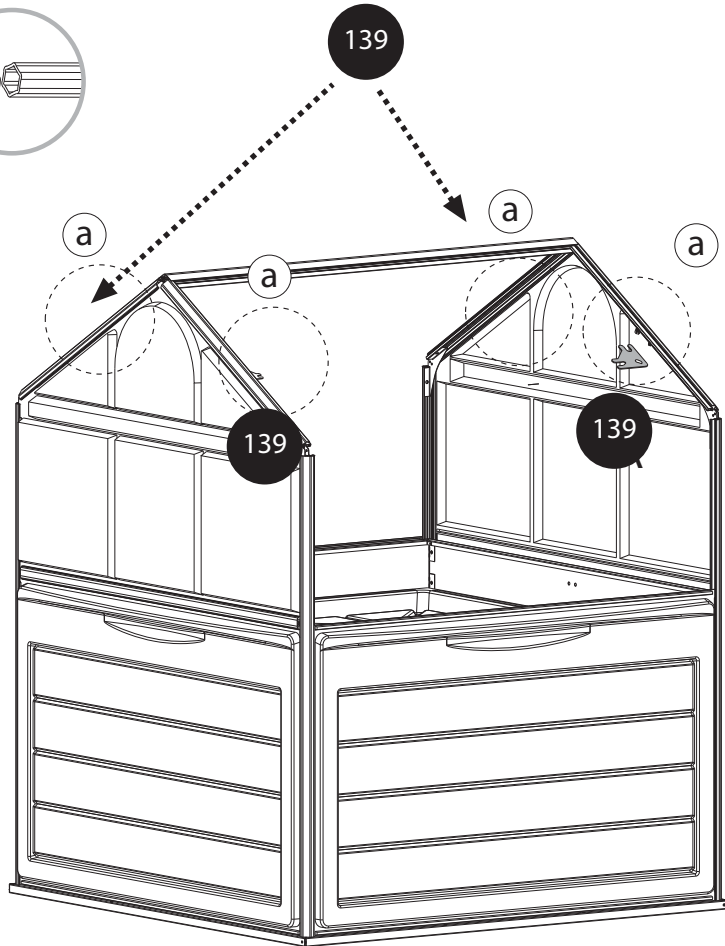
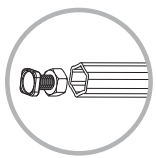

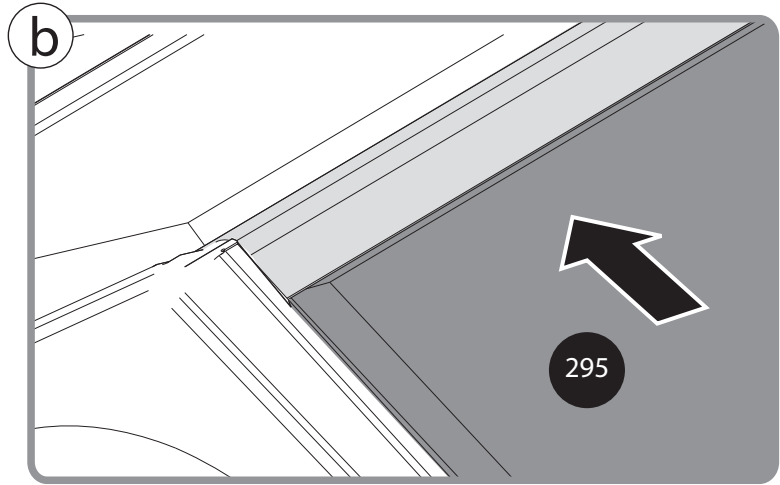
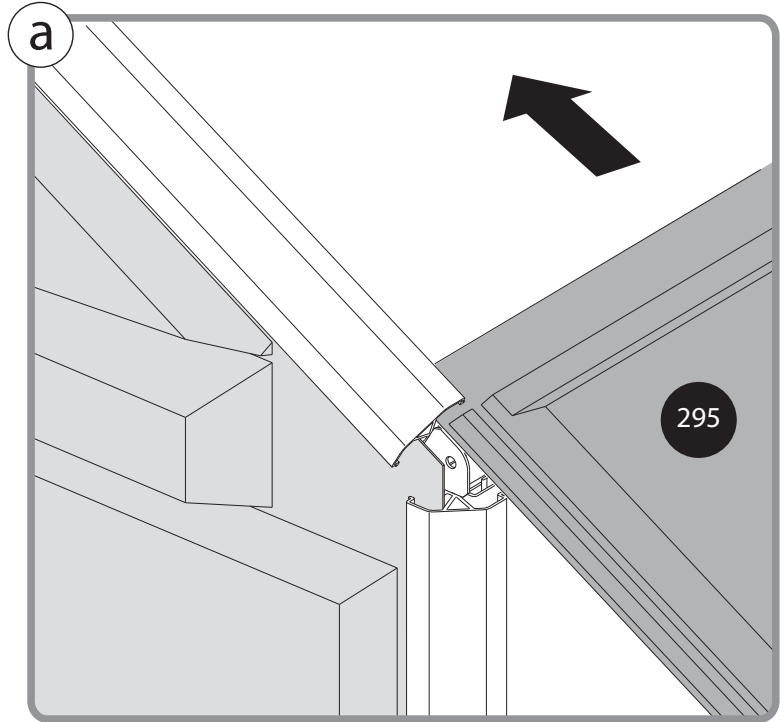
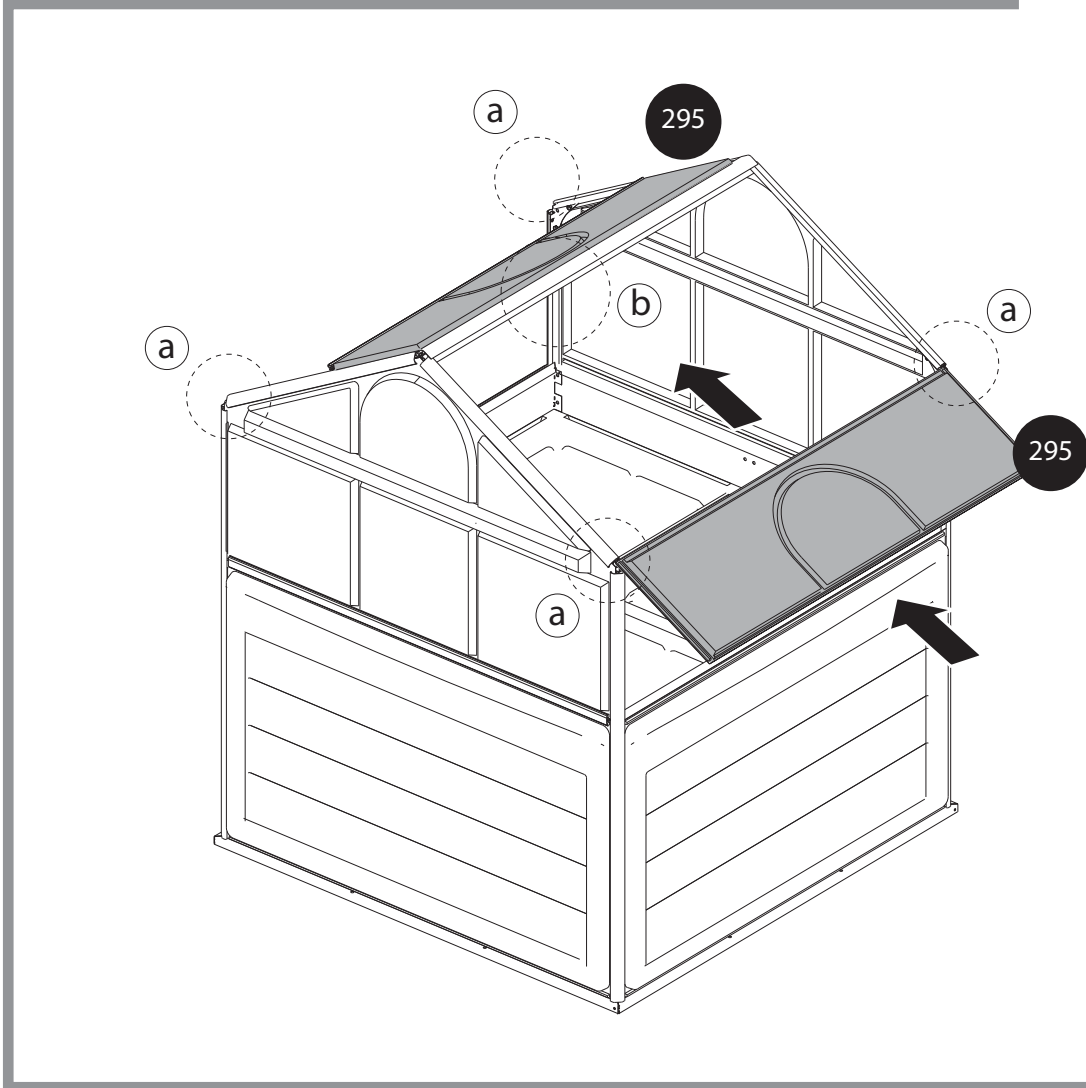
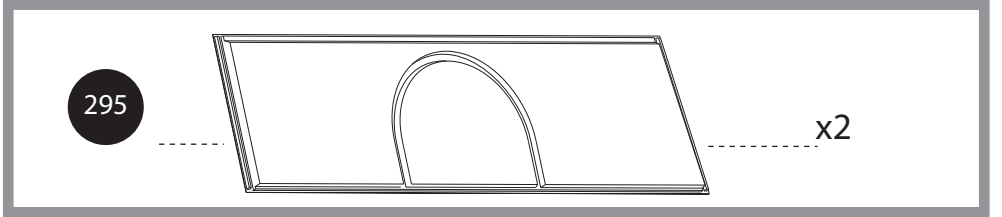
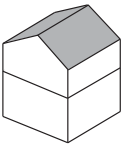

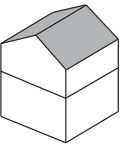

x2

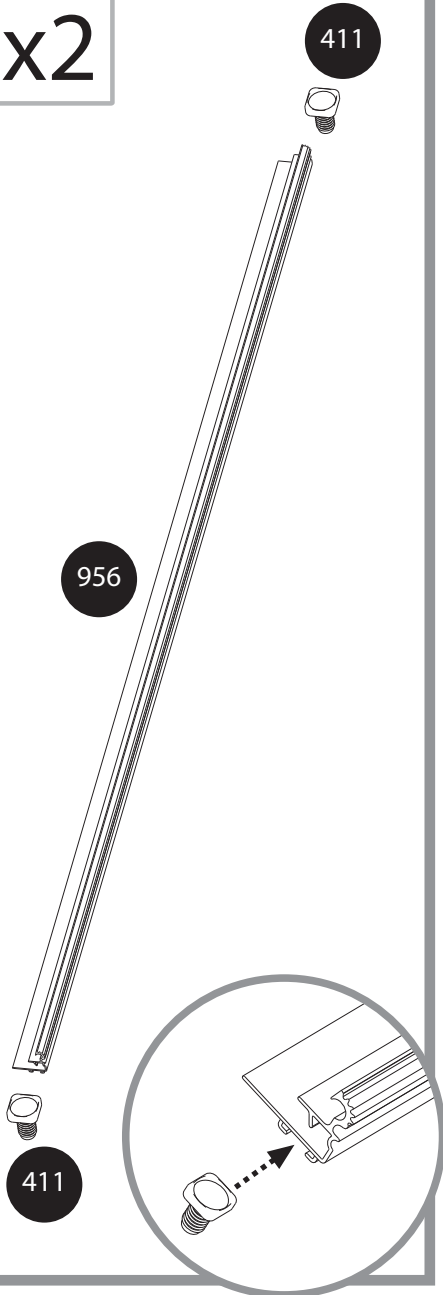

956



x2

411



x4

412



x4

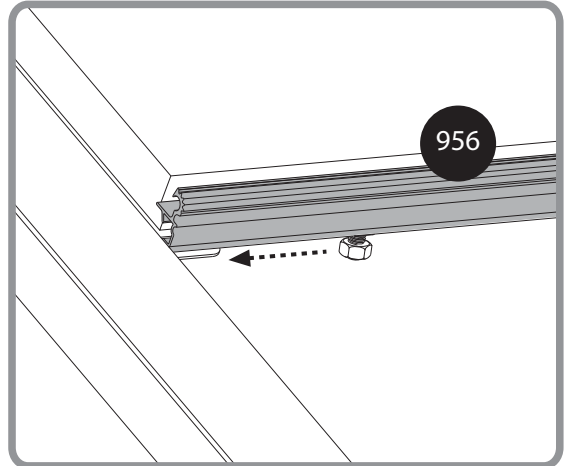
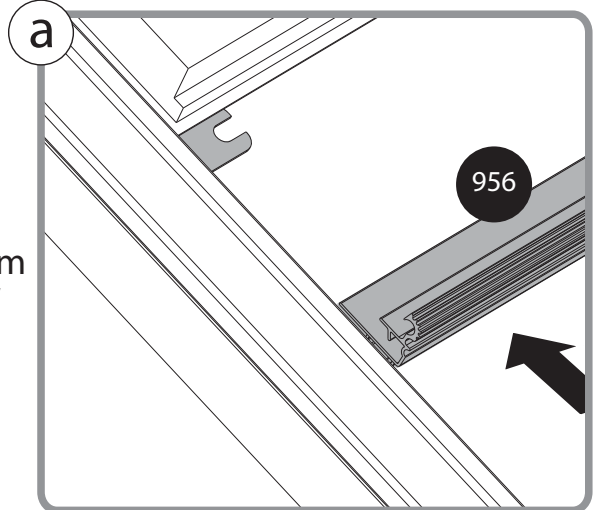
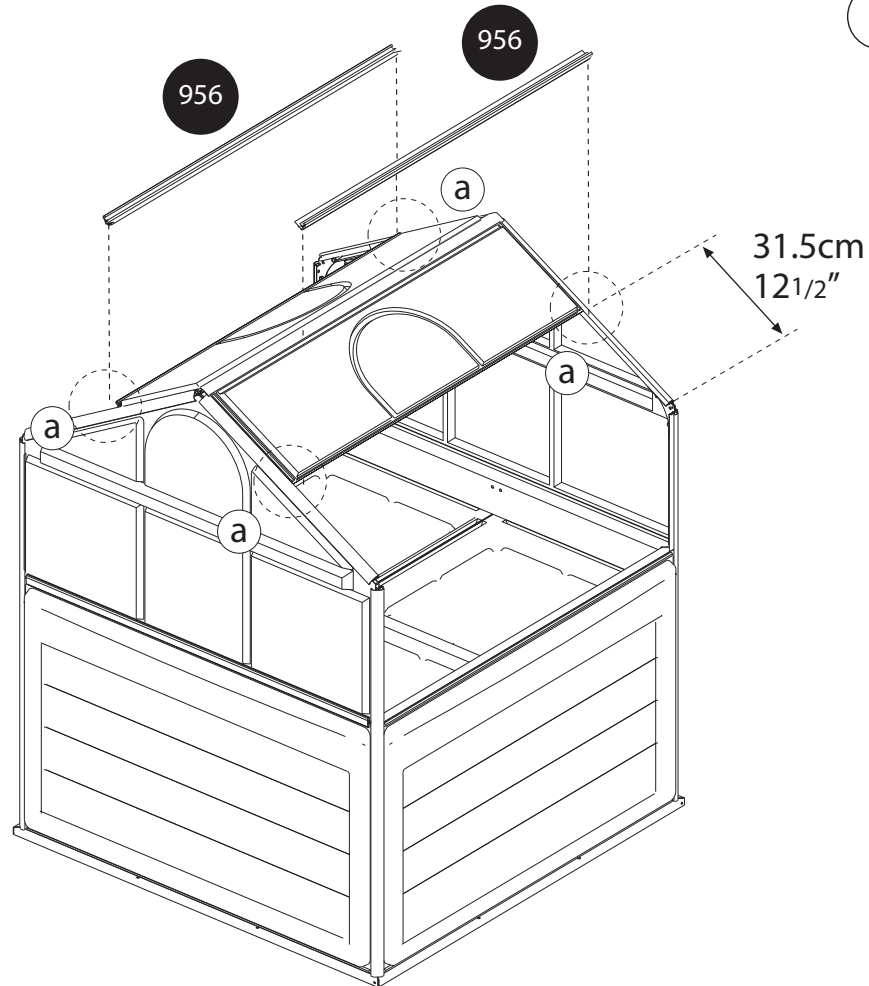

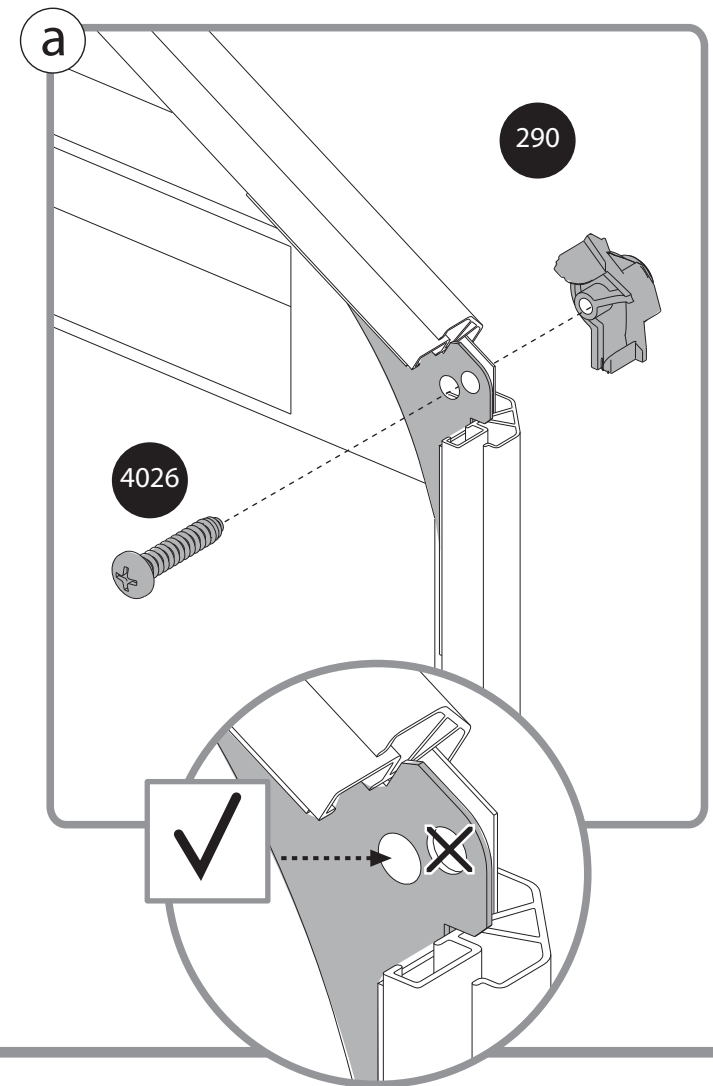
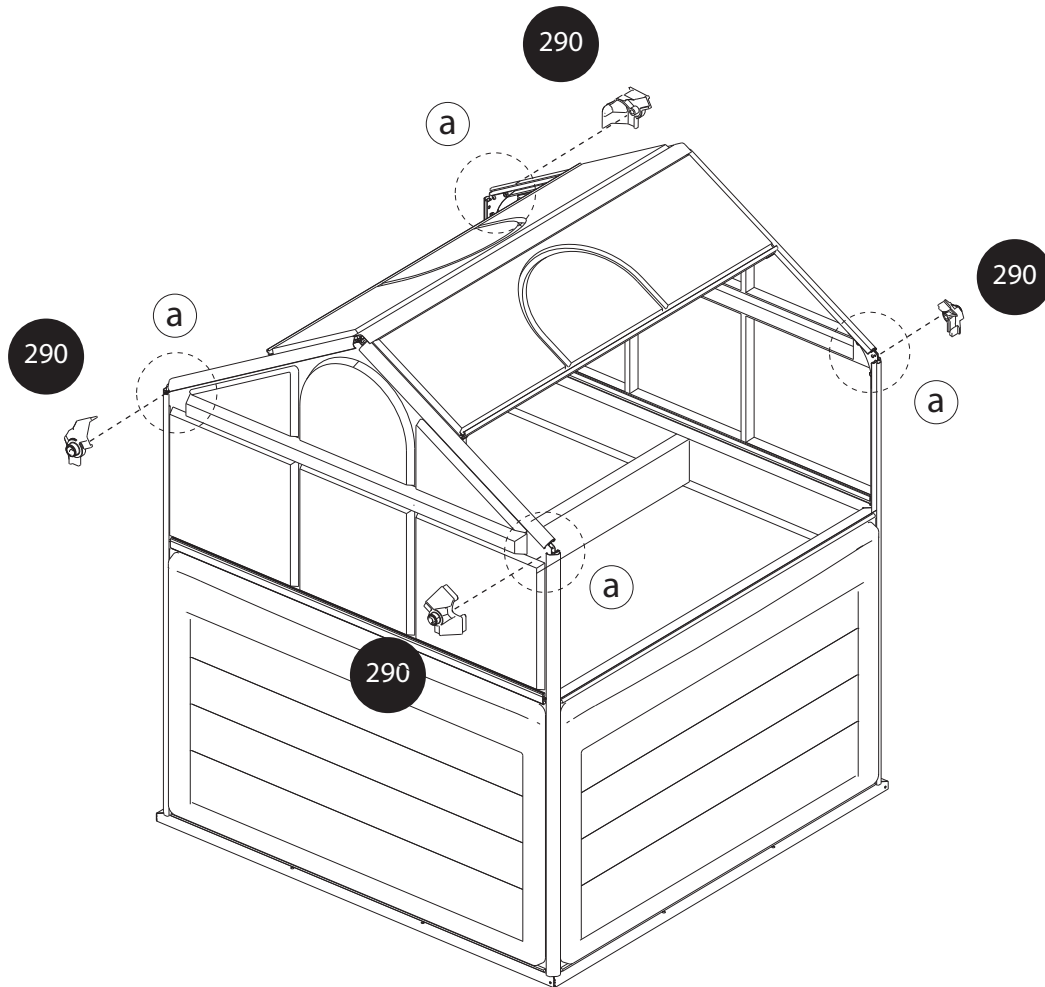
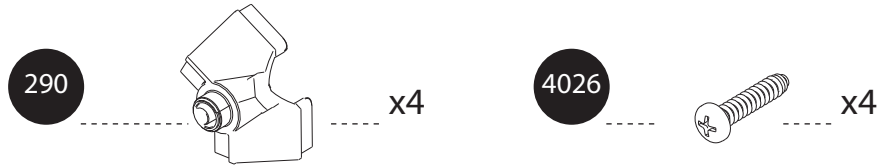
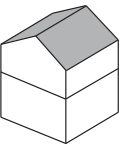

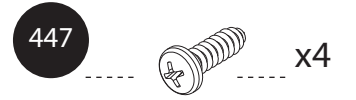
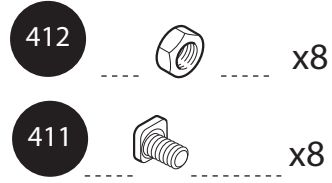
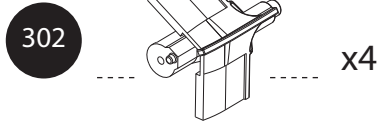
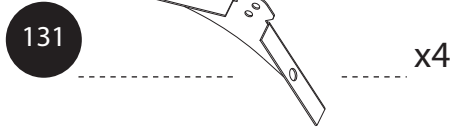
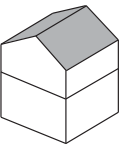

x4

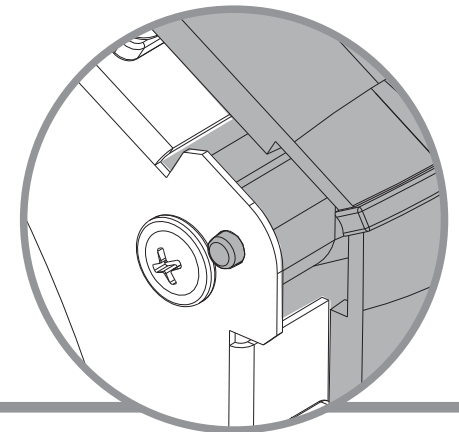
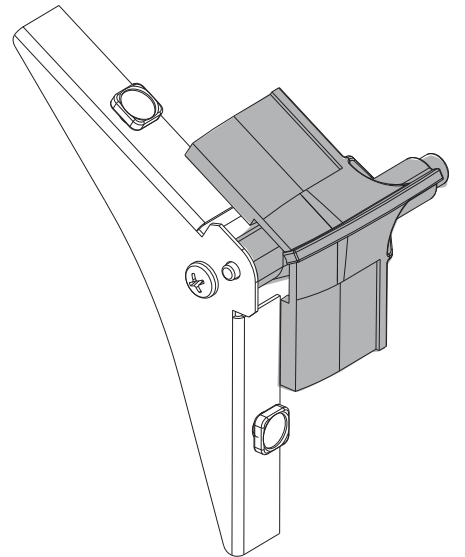
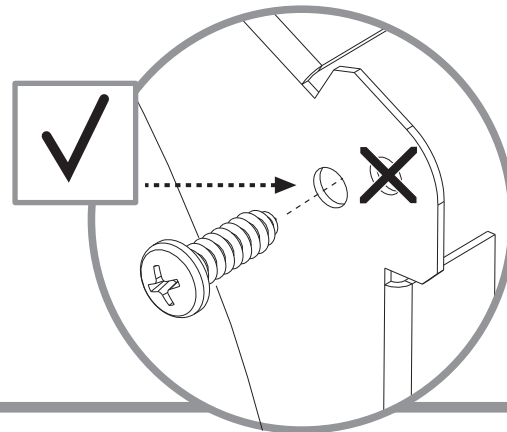
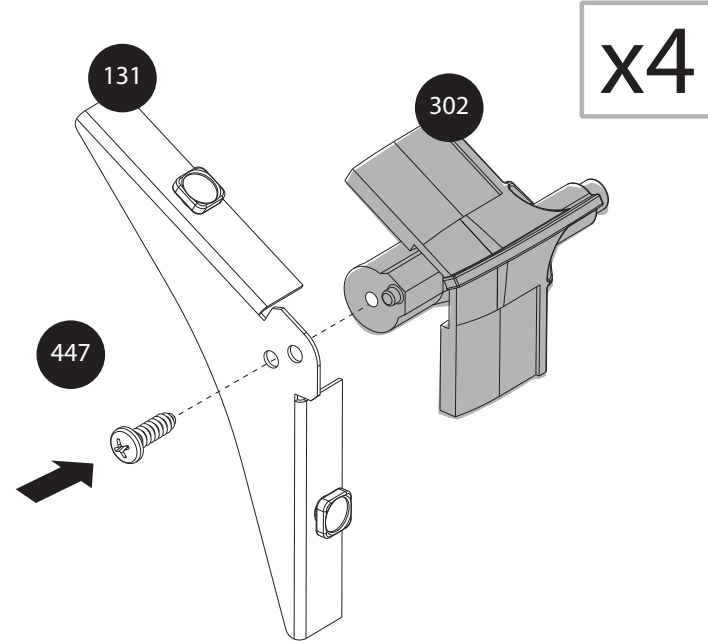
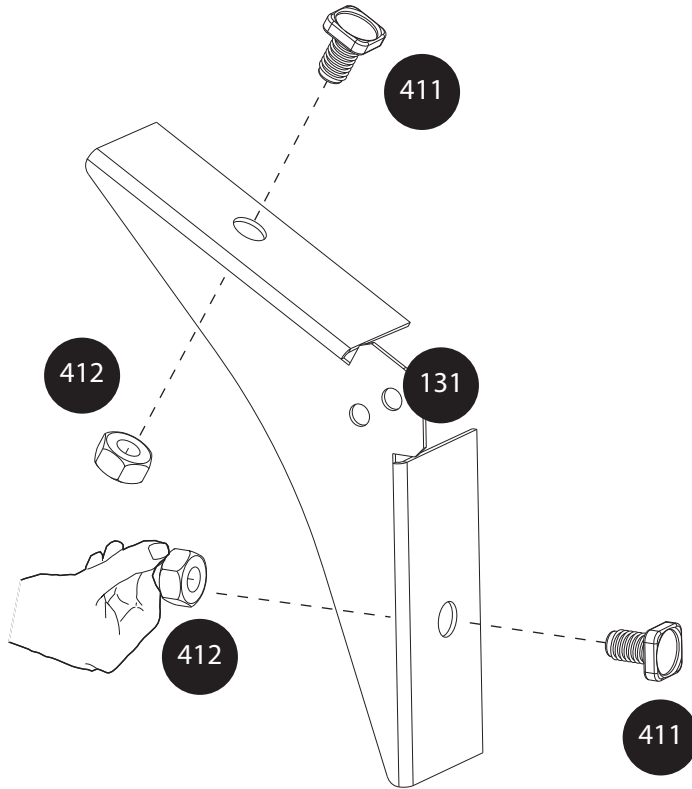

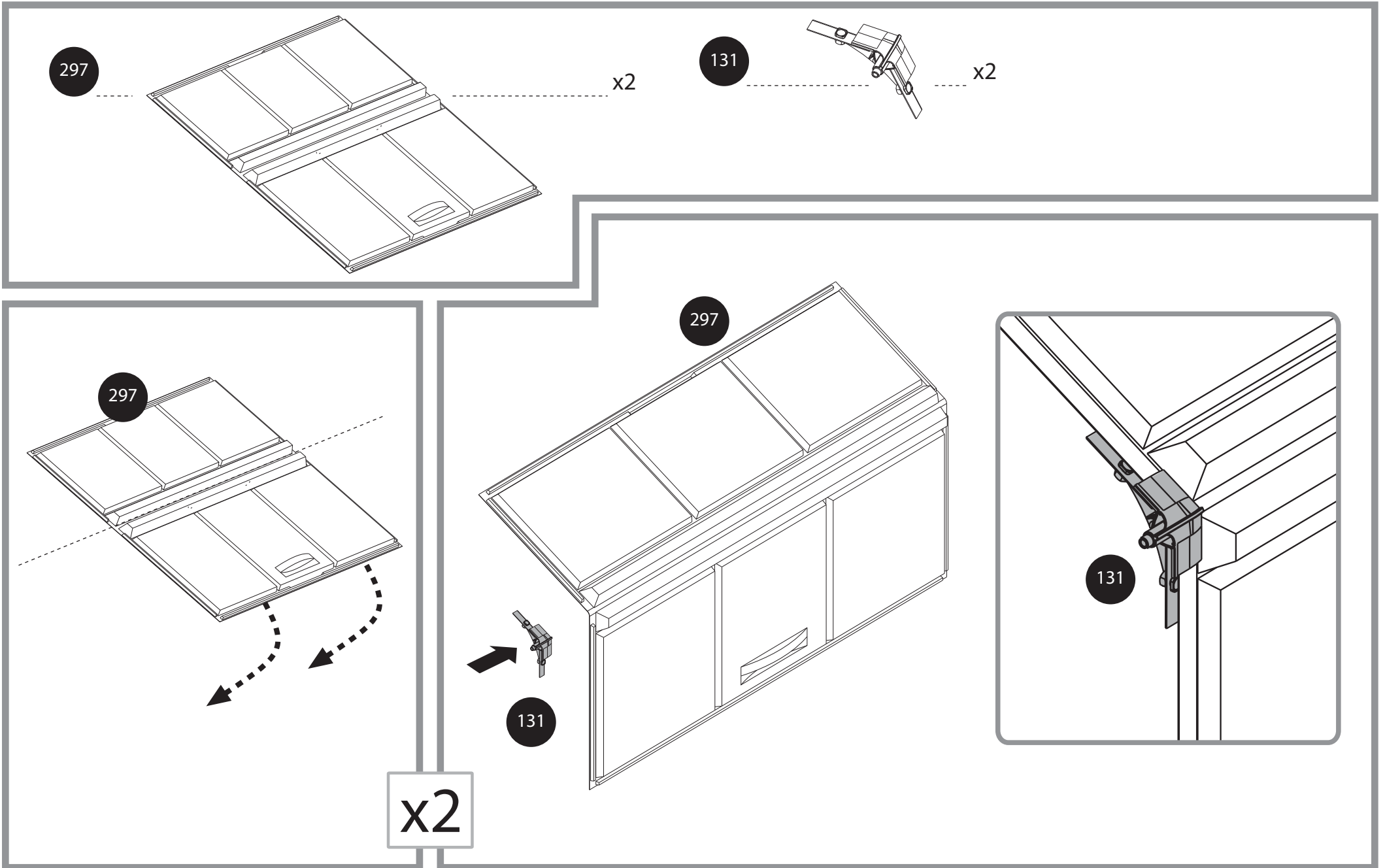
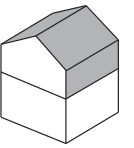

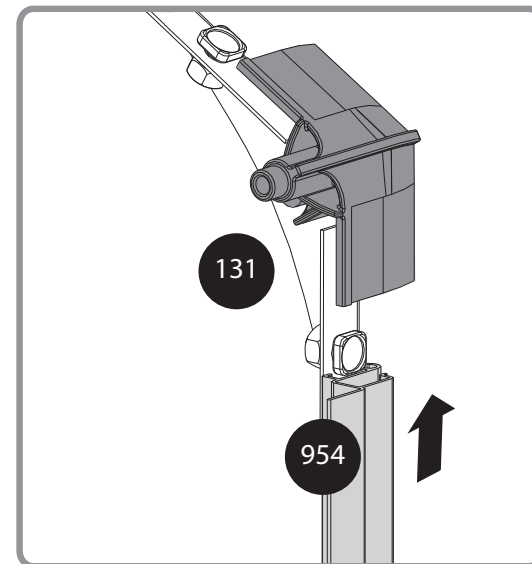
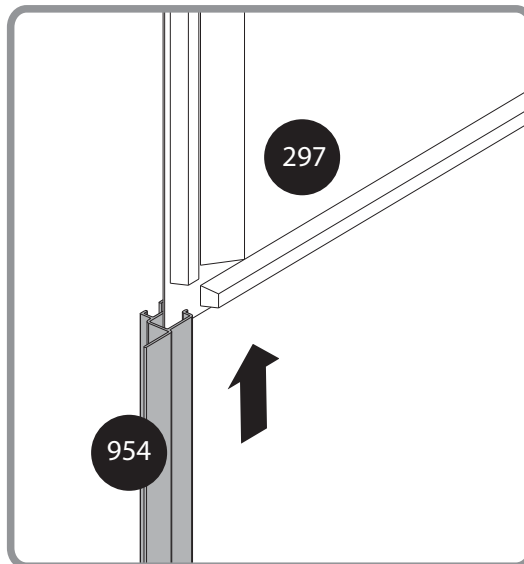
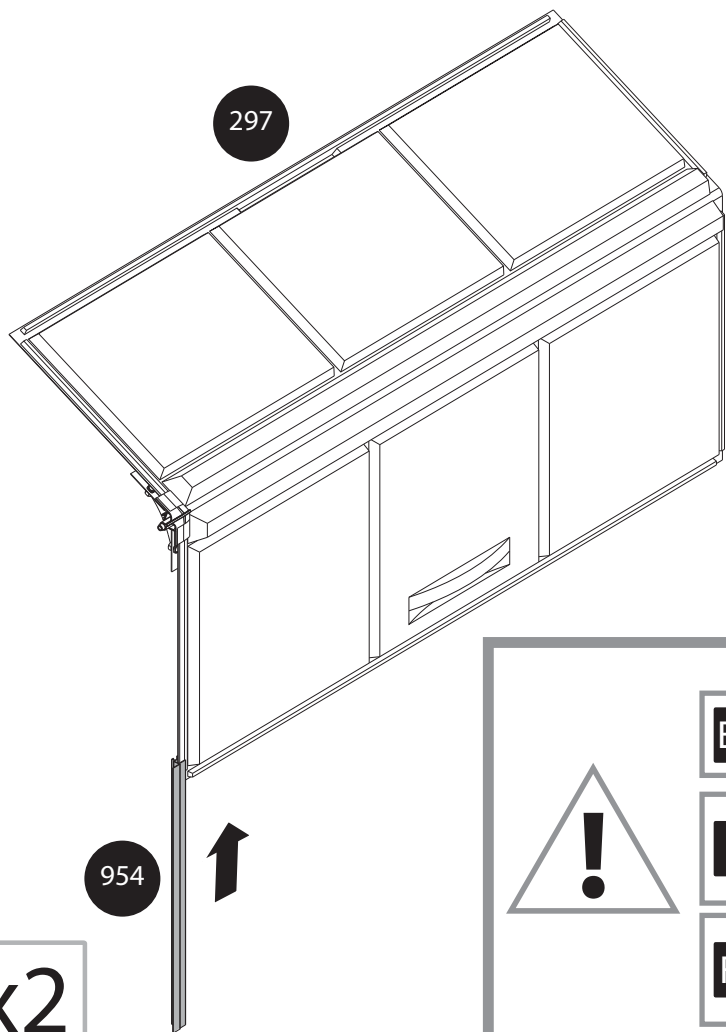
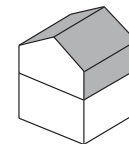

EN make sure profiles are inserted all the way till the end into plastic connector.

D Stellen Sie sicher, dass die Profile den ganzen Weg bis zum Ende in den Kunststoffanschlüsse eingefügt sind

FR Assurez-vous que les profils sont insérés dans le connecteur en plastique sur toute la longueur.

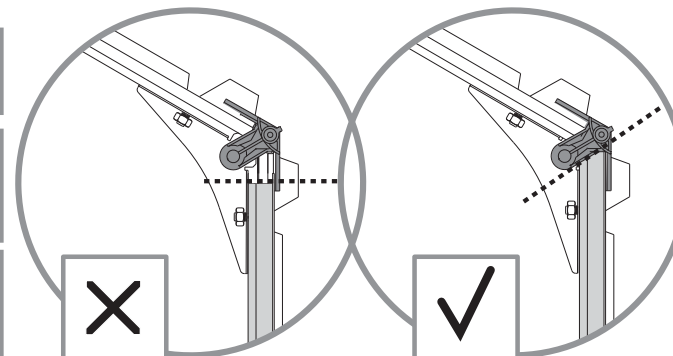

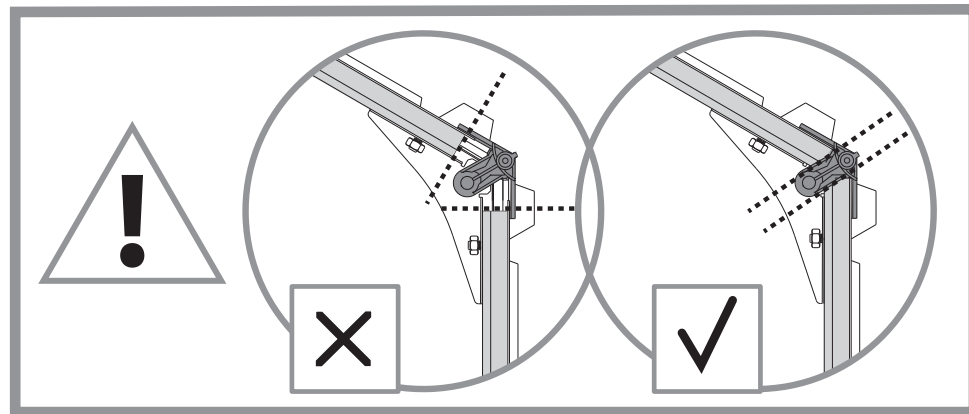
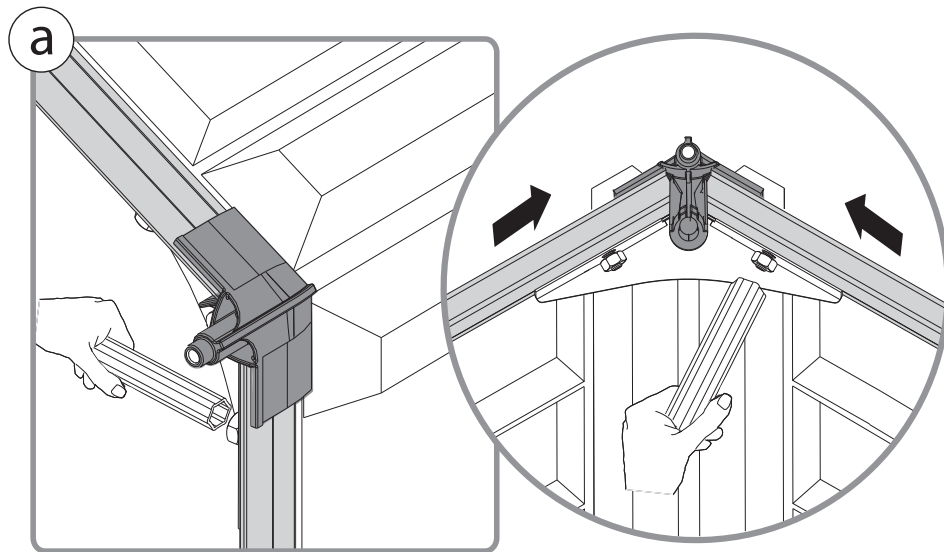
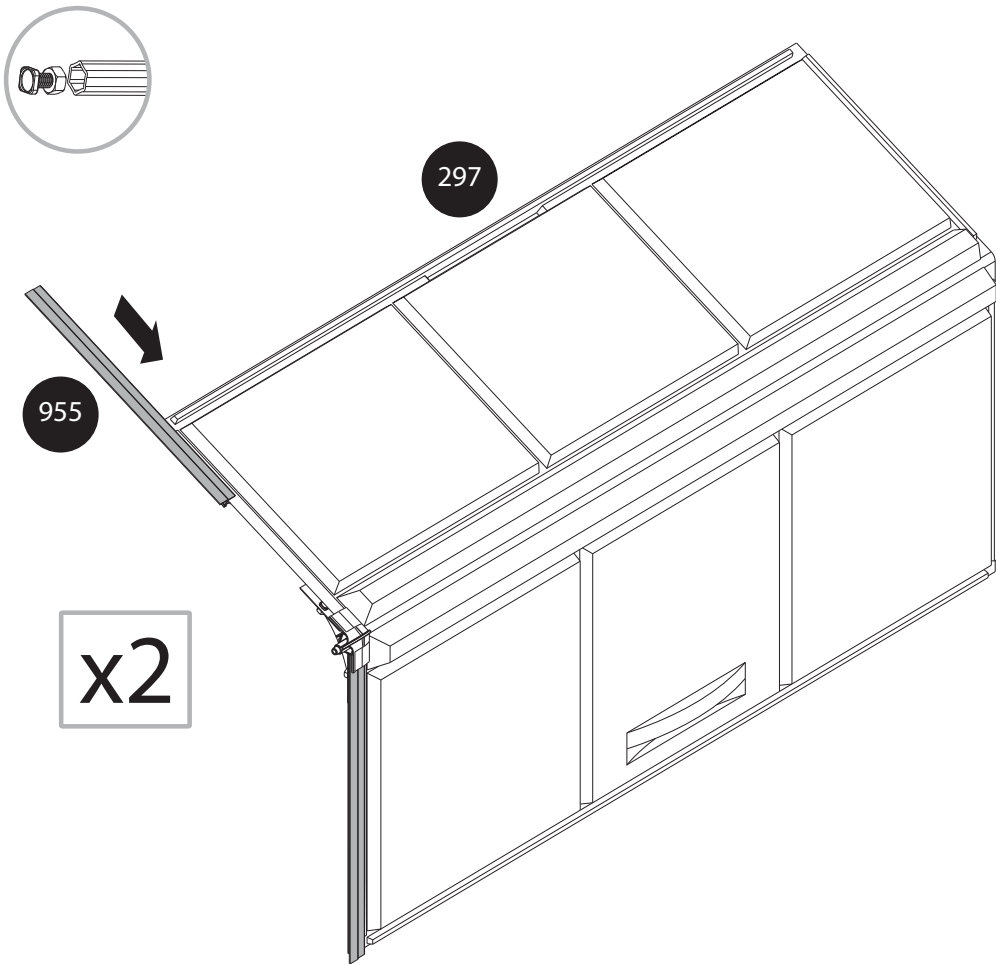
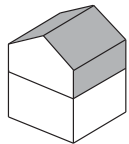

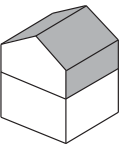

131

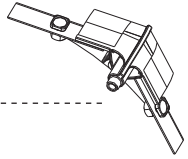

x2

954



x2

955



x2

x2

297

955

131

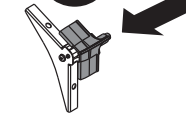

954

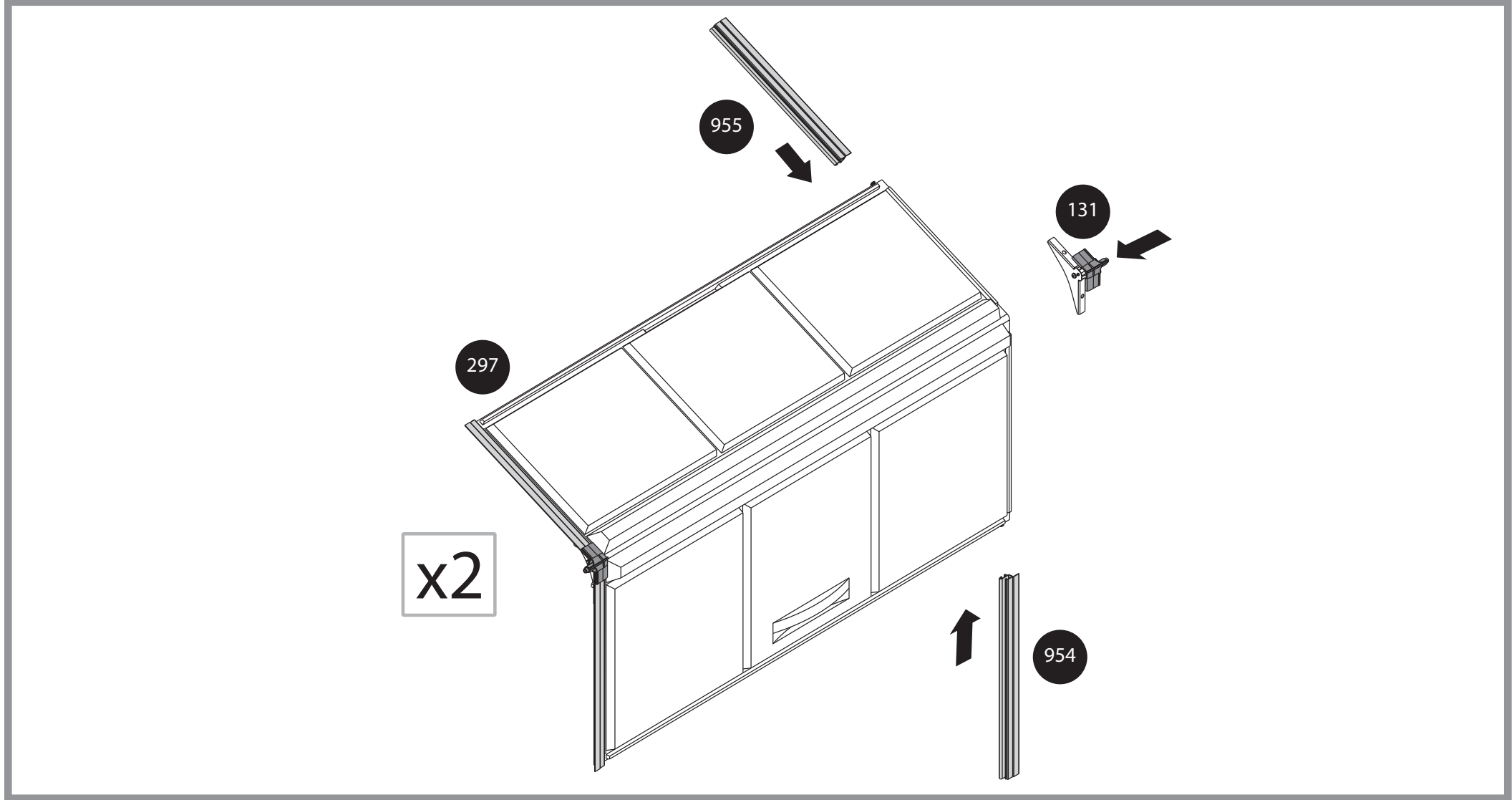

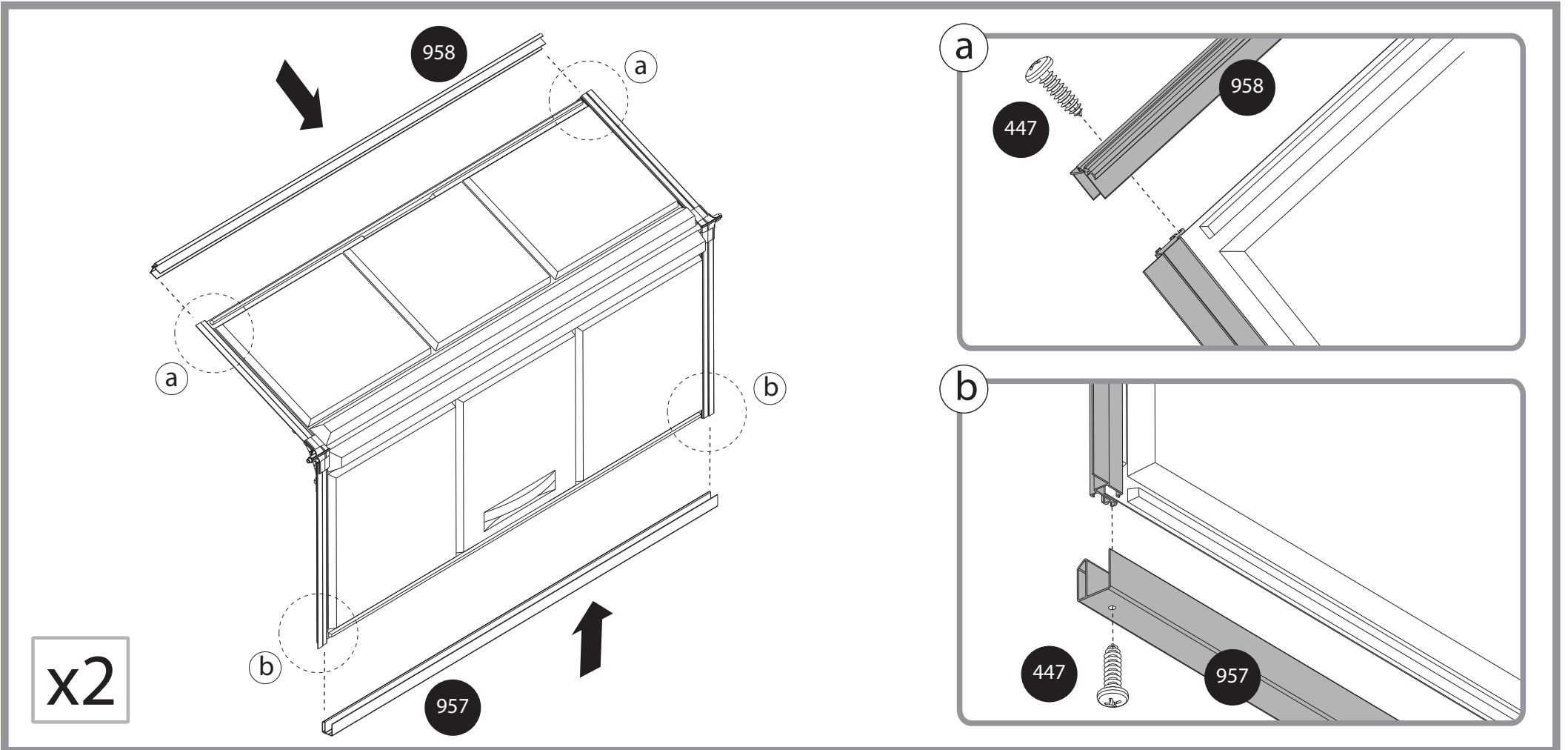
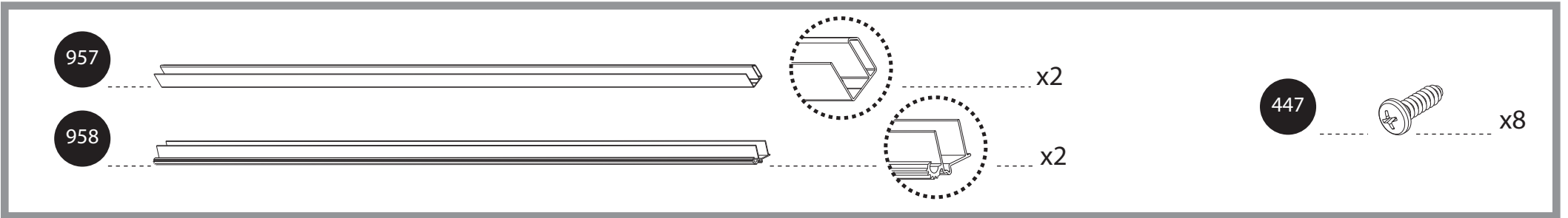
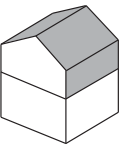

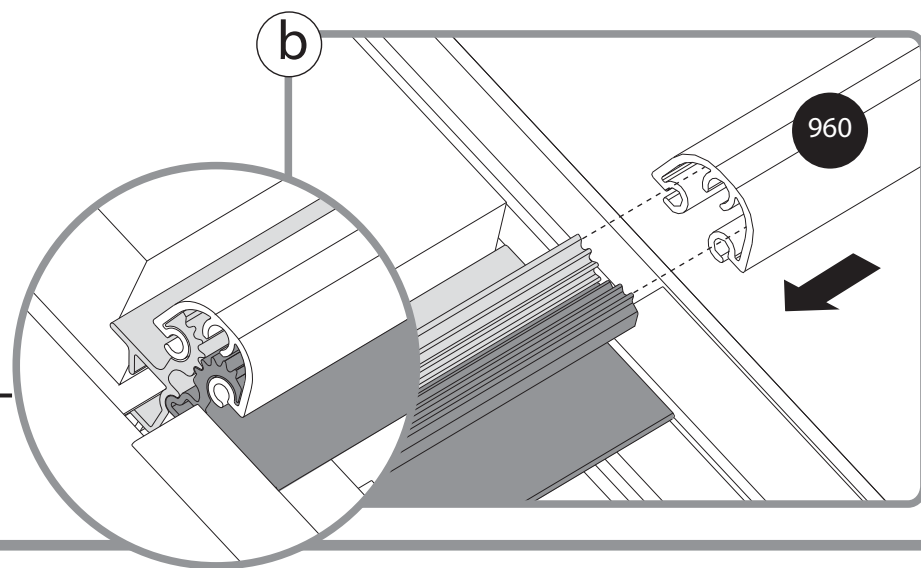
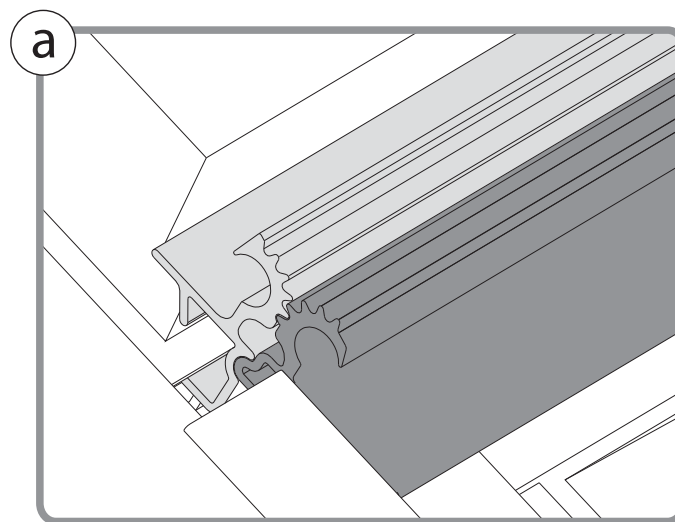
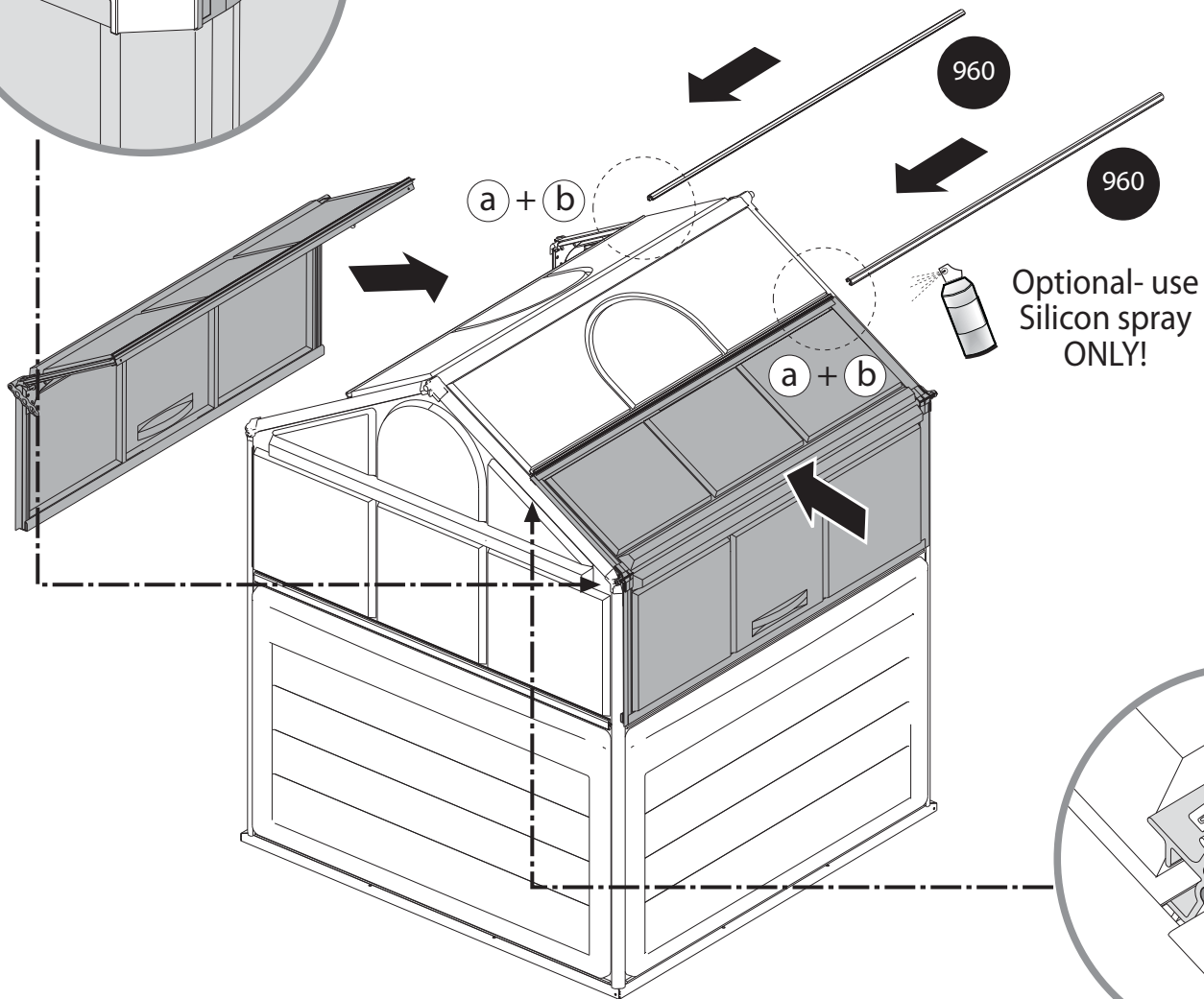
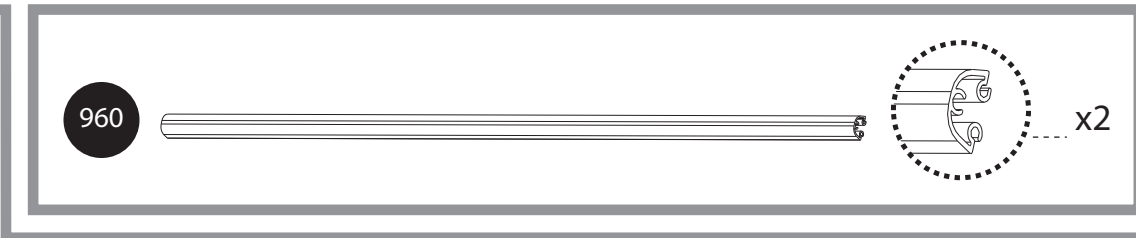
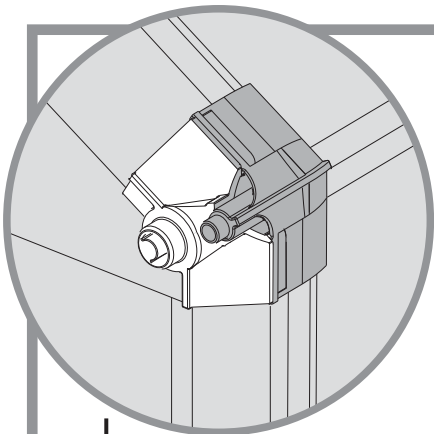
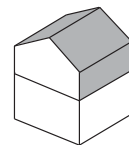

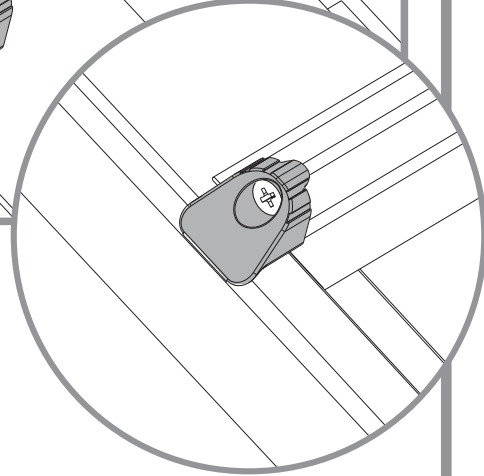
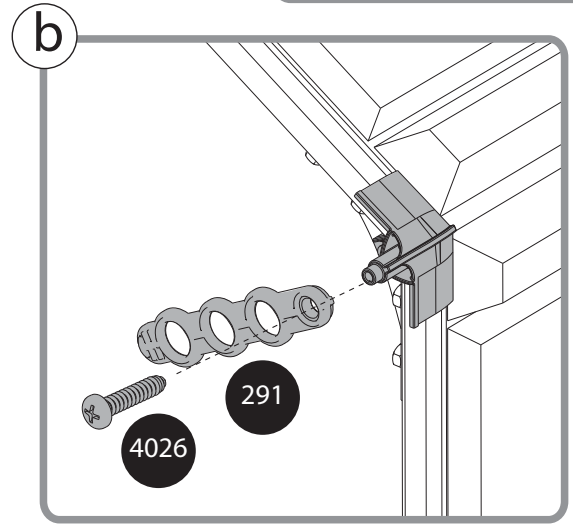
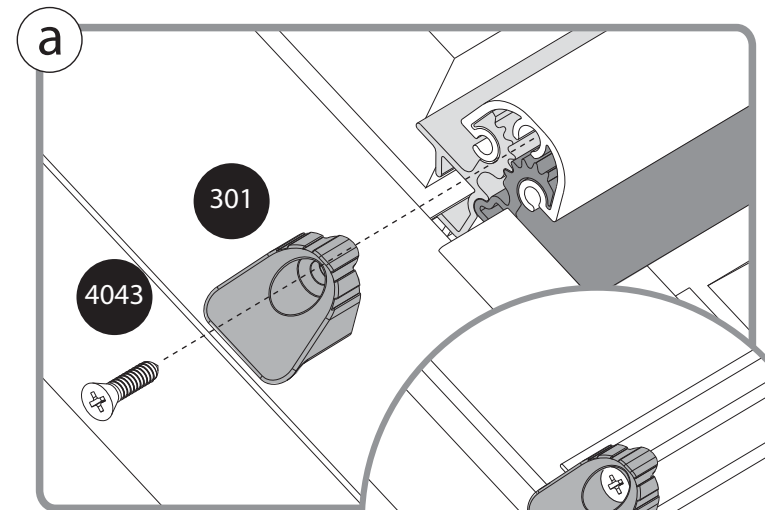
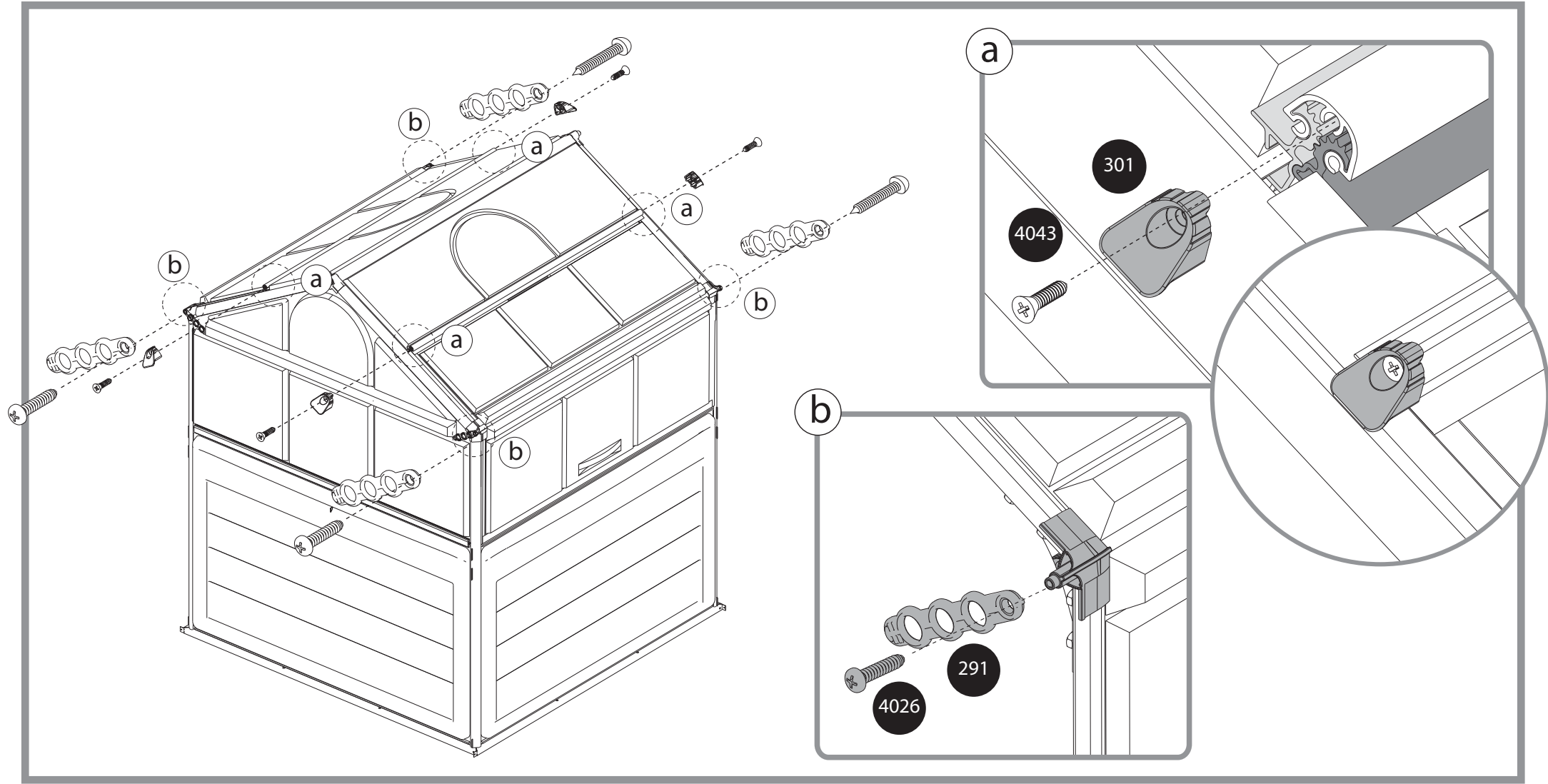
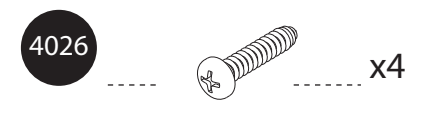
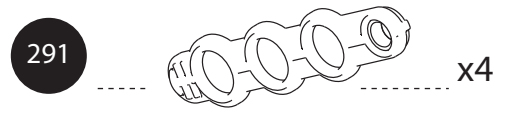
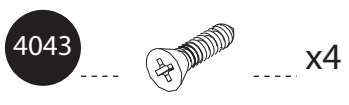
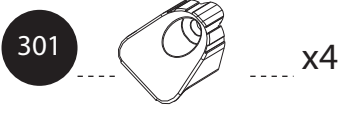
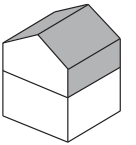

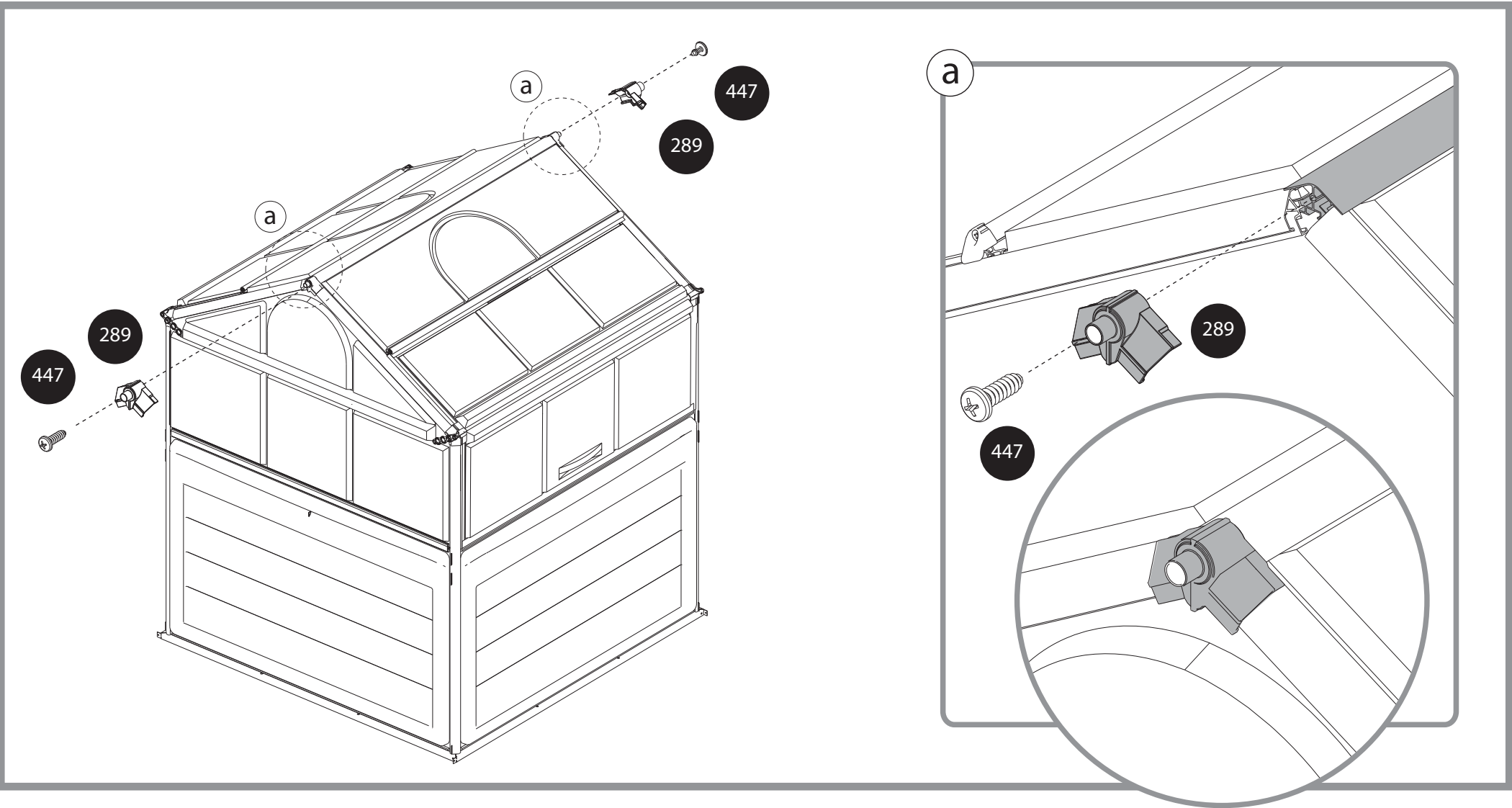
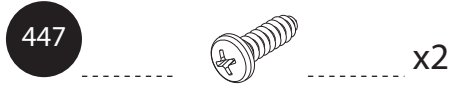
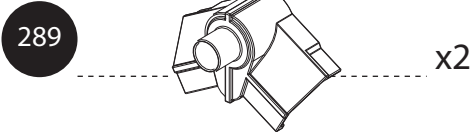
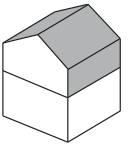

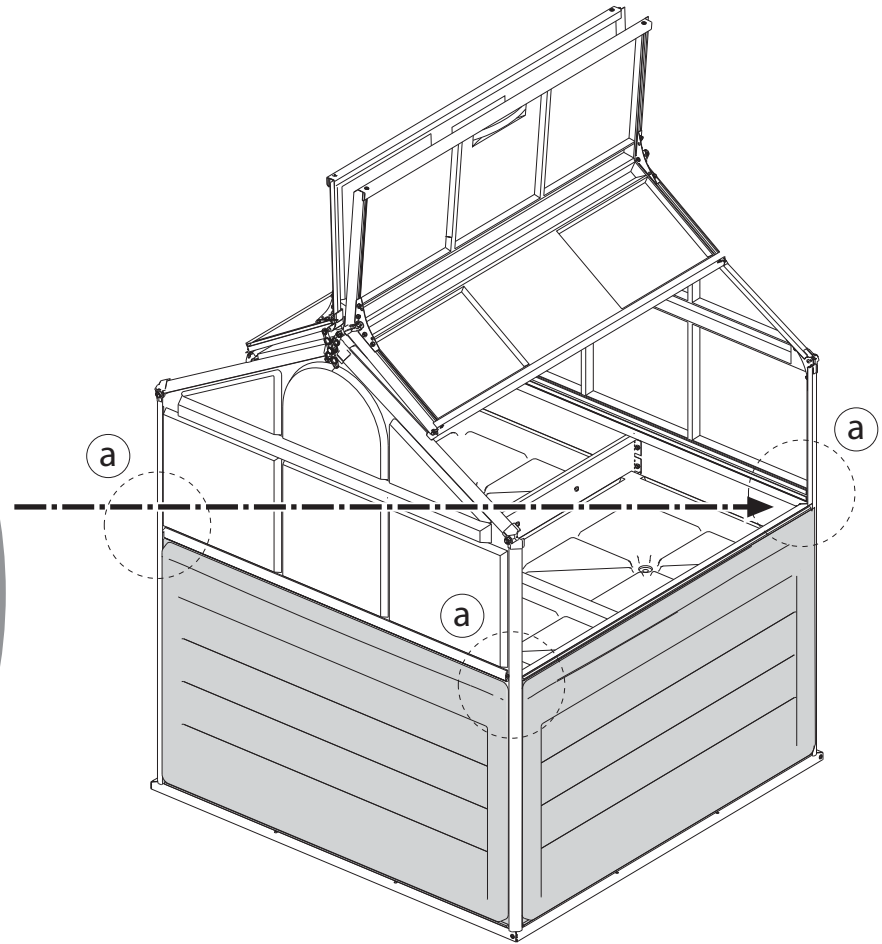
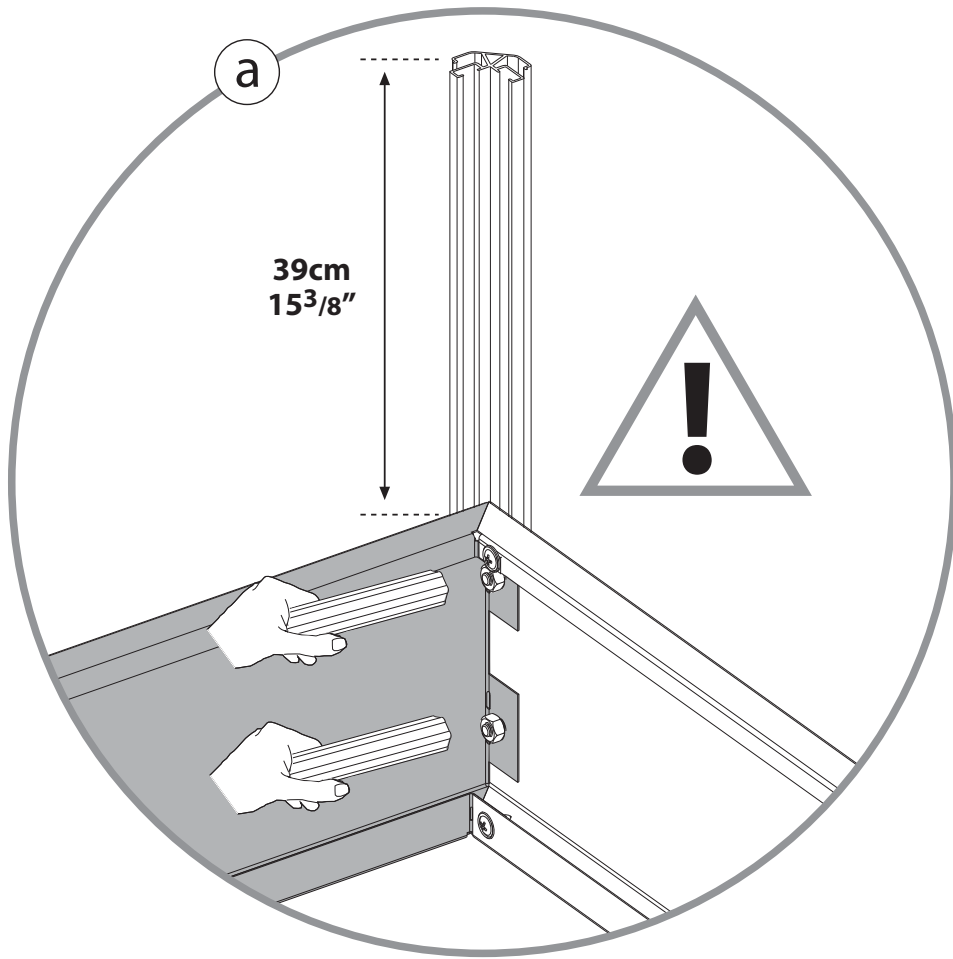

35 Positions

Close

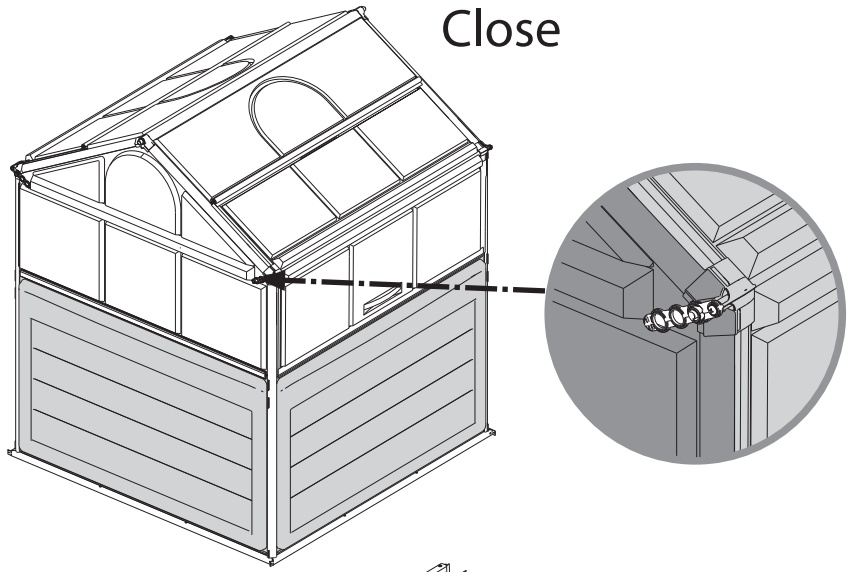

Ventilation

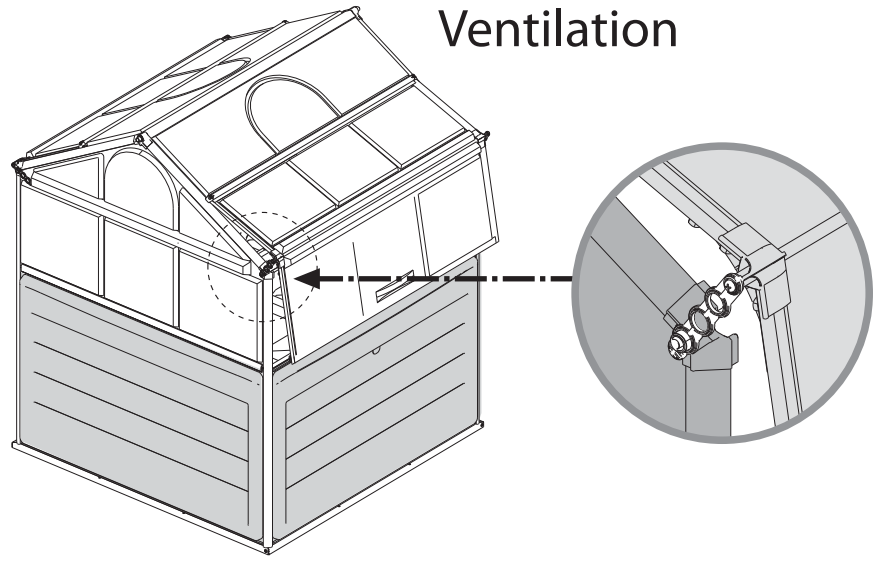

Open

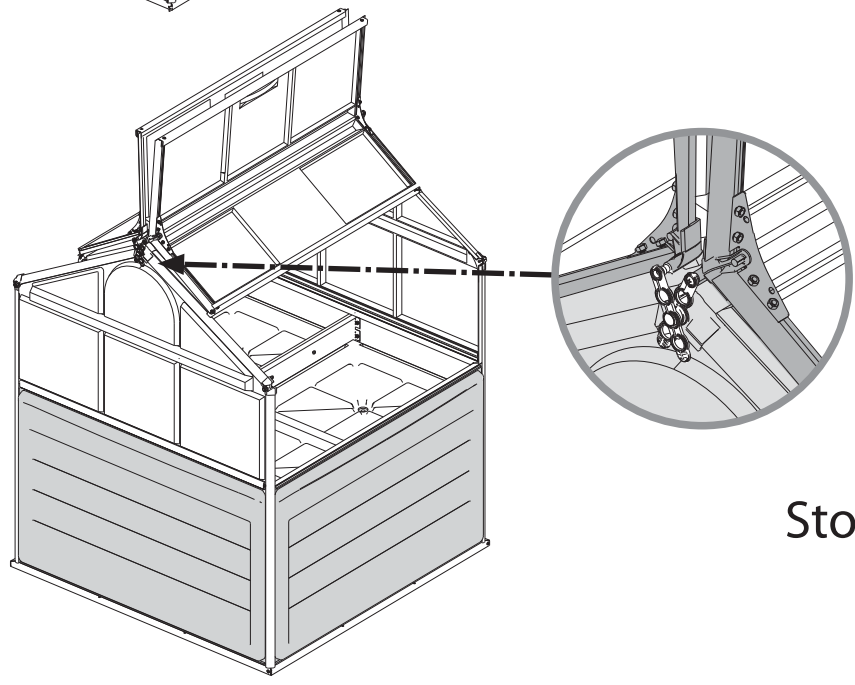

Storage

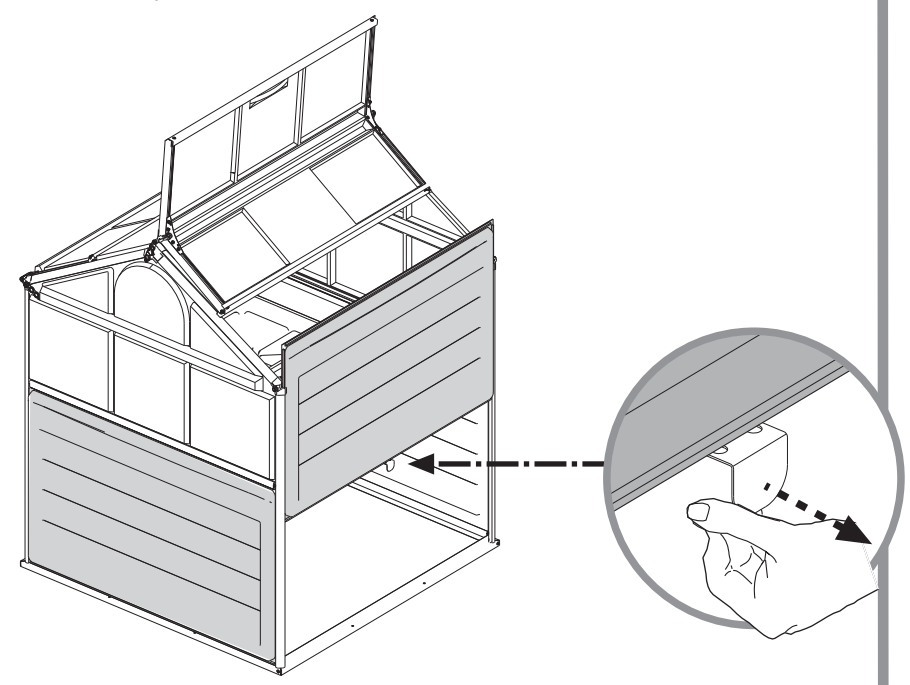

36 Planting & Trellising

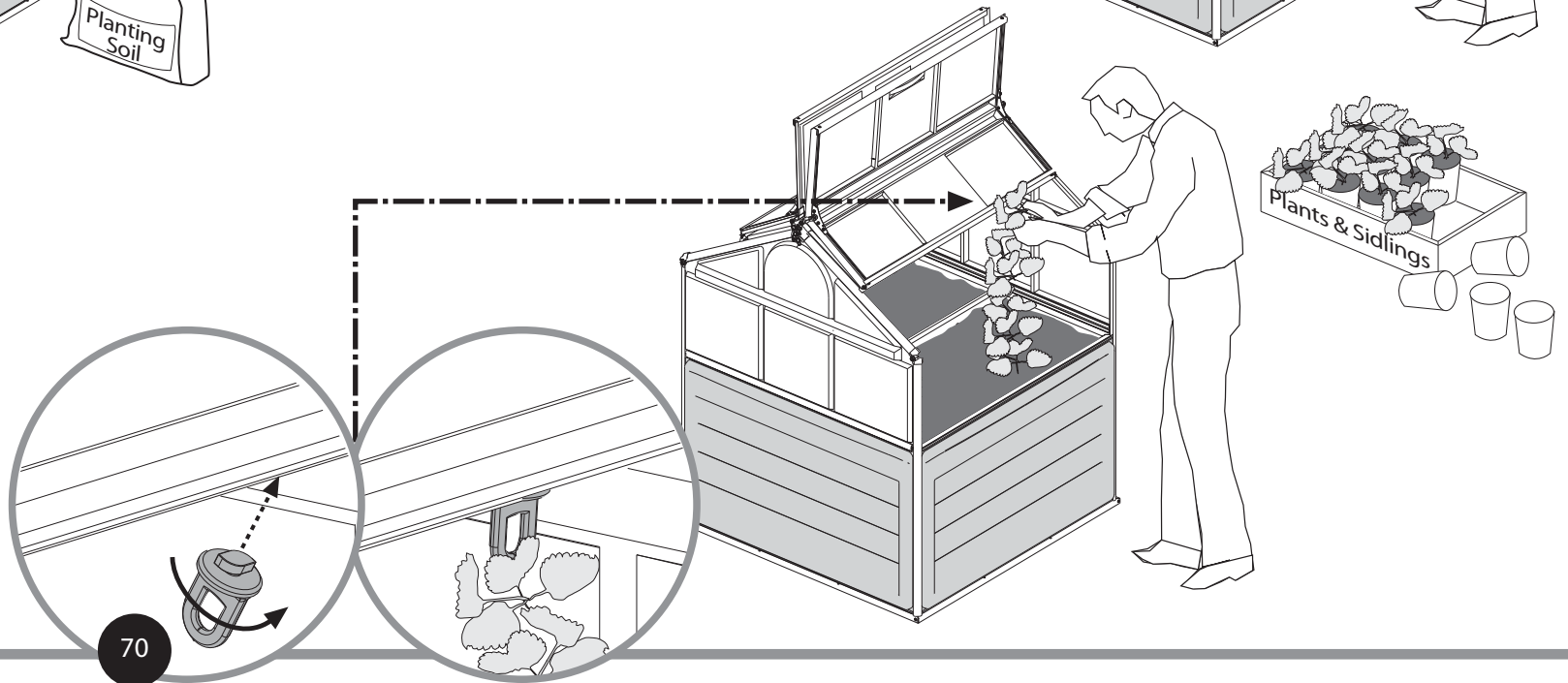
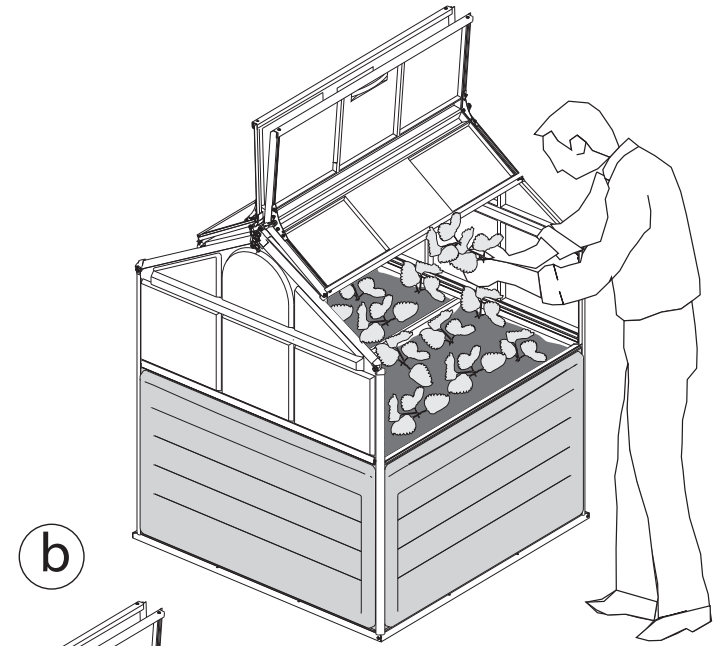
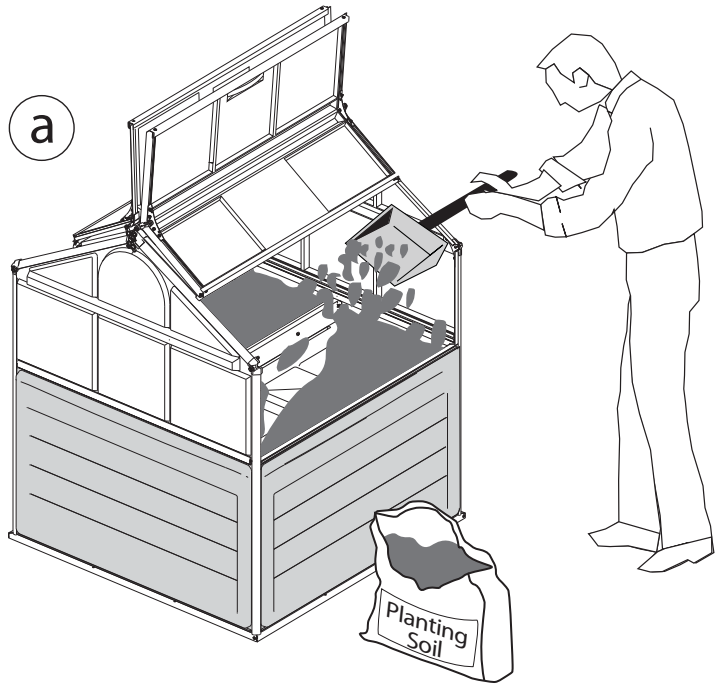

37 Water Draining

- 70  x4
- 67  x4

