

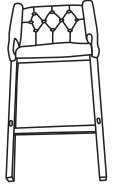







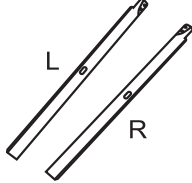
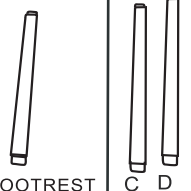

ITEM: GHSTL-1295	Ax1 BACK	Bx1 SEAT	Cx2 FRONT LEGS	Dx3 SIDE STRETCHERS-CD FOOTREST	Ex2 SCREWS	Fx5 SCREWS	Gx4 SCREWS	Hx6 TAPPING SCREWS	Ix11 WASHER	Jx1 SPANNER	Kx11 SPRING WASHER
											

STEP1

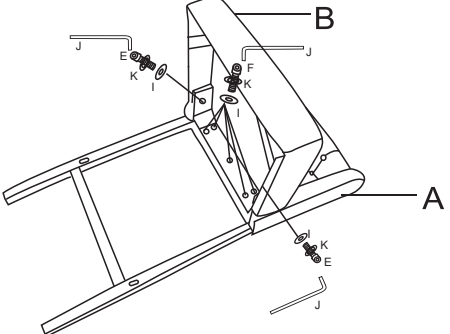

Loosely install the center bolt first, then loosely install both sides

STEP2

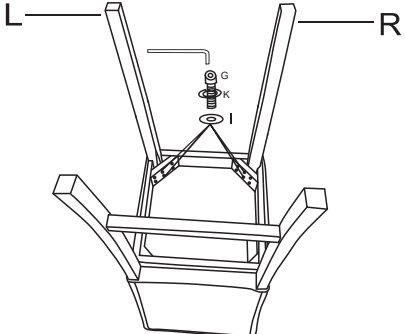

Firm pressure is required to push legs into the leg pockets

STEP3

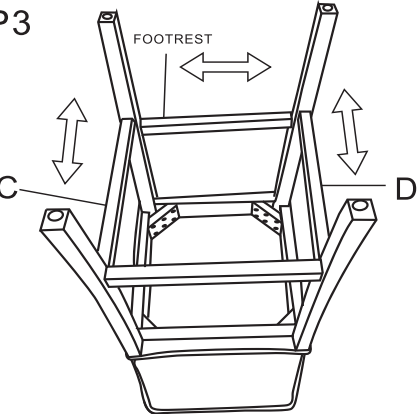

Note: Side stretchers are directional

STEP4

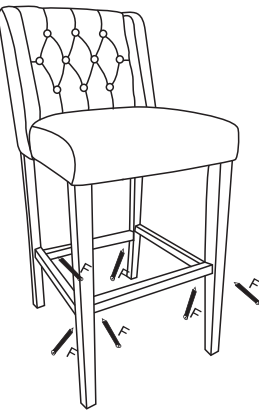

Tighten all bolts properly on even ground

ASSEMBLY INSTRUCTION

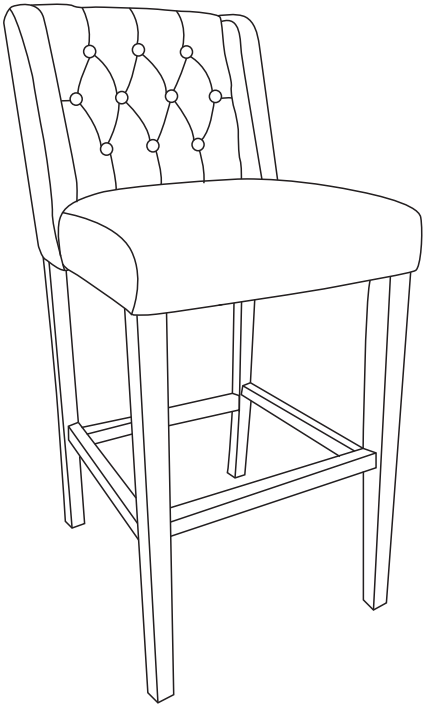

CLEANING OF PU/LEATHER COVER - WIPE CLEAN WITH A SOFT CLOTH MOISTENED WITH WATER AND NEUTRAL DETERGENT. DO NOT USE BLEACH,CHEMICAL OR BIOLOGICAL CLEANERS.