

# Assembly Instructions

**CAUTION :** You must read this before you proceed

## Sofa

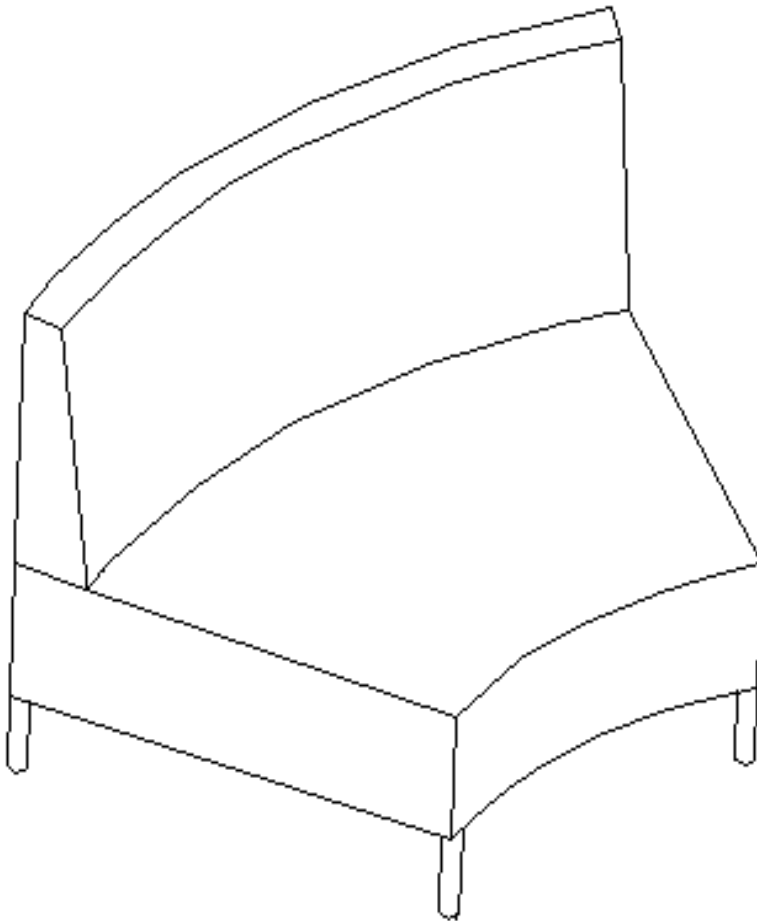



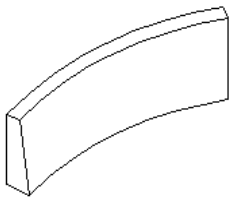
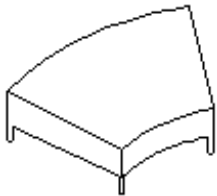

**CAUTION :** This is NOT a TOY.  
Keep your child / children at bay during the assembly process.

## Parts List

Label	Picture	Description	QTY
A		Sofa Back	1
B		Sofa Seat	1

## Hardware

Label	Picture	Description	QTY
C		Angled Wrench	1
D		Bolt M8*45mm	5
E		Spring Washer	5
F		Flat Washer	5

# Assembly Preparation

Before Beginning Assembly:

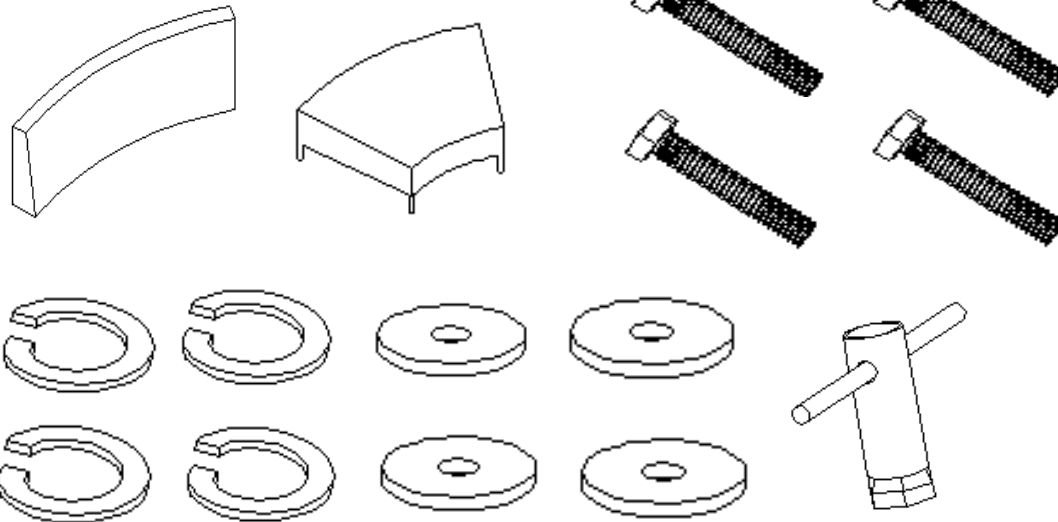

- Read instructions, cover to cover-



- Have 2 adults on hand for assembly-



- Do not assemble on flooring or carpet-



- Assemble on a clean non-marring surface (packing foam)-



- Save all packaging until finished-

## Assembly Steps

### Step 1

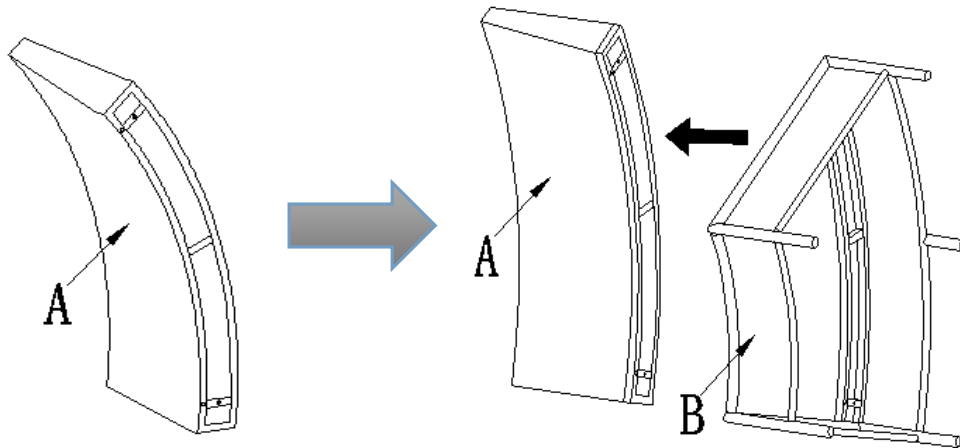

Open the carton and place all the parts onto a clean and soft surface.

Place the Sofa Backrest(A) on its side, then attach the Sofa seat (B) to the Sofa Backrest(A) as pictured above.

### Step 2

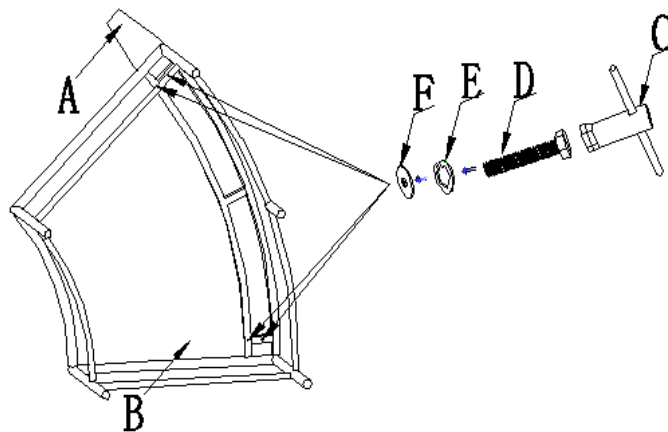

Using hardware(F, E, D) with the Angled Wrench at the 4 positions pictured above.

**Do Not Tighten until all bolts are in place.**

Step 3

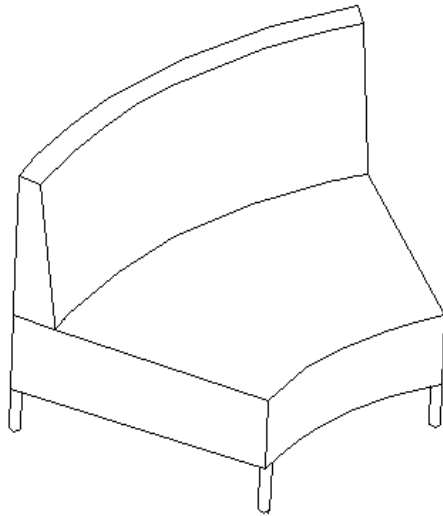







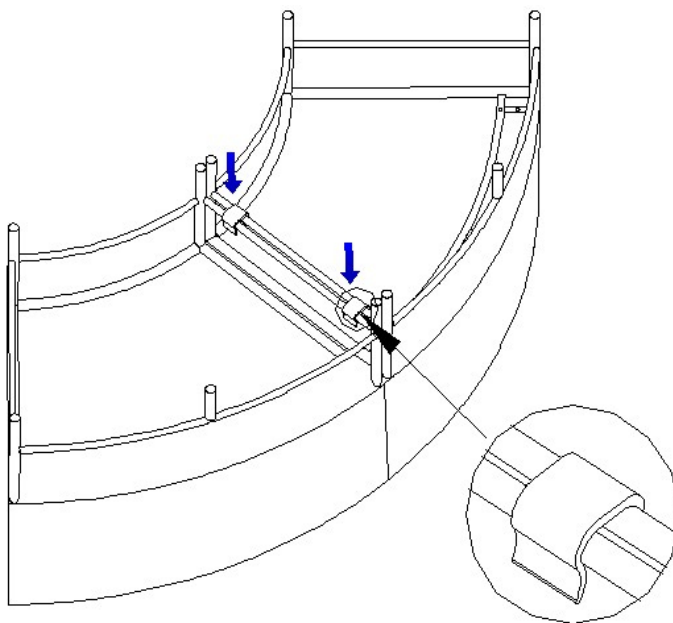

Turn the Sofa rightside. Now your Sofa is ready for use.

**Additional Hardware :**

In the event that you should purchase in excess of one piece of this sofa, there is a **CONNECTOR BUCKLE** that is to be used to link up this sofa to achieve a Sectional Sofa.



## Care & Maintenance

- ⊘  ● Do not put **HOT** items directly on furniture surface.
  - ⊘  ● Do not clean furniture with **HARSH** cleansers or polish.
  - ⊘  ● To prolong product lifetime, **AVOID** placing furniture under direct sunlight.
  - ⊘  ● Do not place furniture near **heating or cooling** vents.
  - ⊘  ● Do not write on furniture without a padded barrier to protect the surface.
  - ⊘  ● To prolong the product lifetime, avoid extended and lengthy exposure to rain and sunshine. Where possible, place under covers and or patio and or awnings.
  - ⊘  ● For residential use only. Not for commercial use.
  - ⊘  ● Stains may be removed with mild soap solution and damp cloth.
- 
- ✓  ● Dust and pick-up spills using a clean, non-colored, lint-free cloth.