

Disposal Description

- EX Series is built for powerful performance and dependable functionality
- 3/4 Horsepower VORTEX™ Motor has powerful grinding capabilities for everyday kitchen scraps
- VORTEX™ Motor features permanent magnet motor technology designed to help reduce jamming
- Universal Xpress Mount™ fits all Moen and most existing 3-bolt mounting assemblies
- Pre-installed power cord - a savings over models where cord must be purchased separately, cord easily removes for optional hardwiring
- SoundSHIELD™ sound deadening insulation
- Compact design frees up space under the sink
- Simple Snap tool quickly secures mounting assembly
- Manual Reset Button
- Garbage disposals reduce waste sent to landfills making it an eco-friendly option for your home
- Easy open dishwasher inlet; no tools required
- Continuous feed with stainless steel turntable & galvanized grind components

Included Components

- EX75c Disposal Unit with Universal Xpress Mount™
- Pre-installed Power Cord, Hardwire Capable
- Removable Splash Guard
- Polished Stainless Steel Sink Flange and Drain Stopper
- Drain Elbow and Mounting Assembly
- Simple Snap tool
- Dishwasher inlet

Warranty & Assurance

- 7 year limited warranty with in-home service
- Safe for use with properly sized septic systems

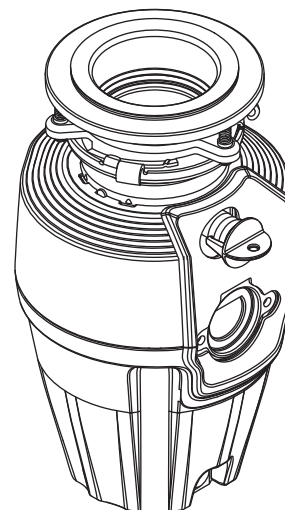

Model: EX75c



Critical Dimensions

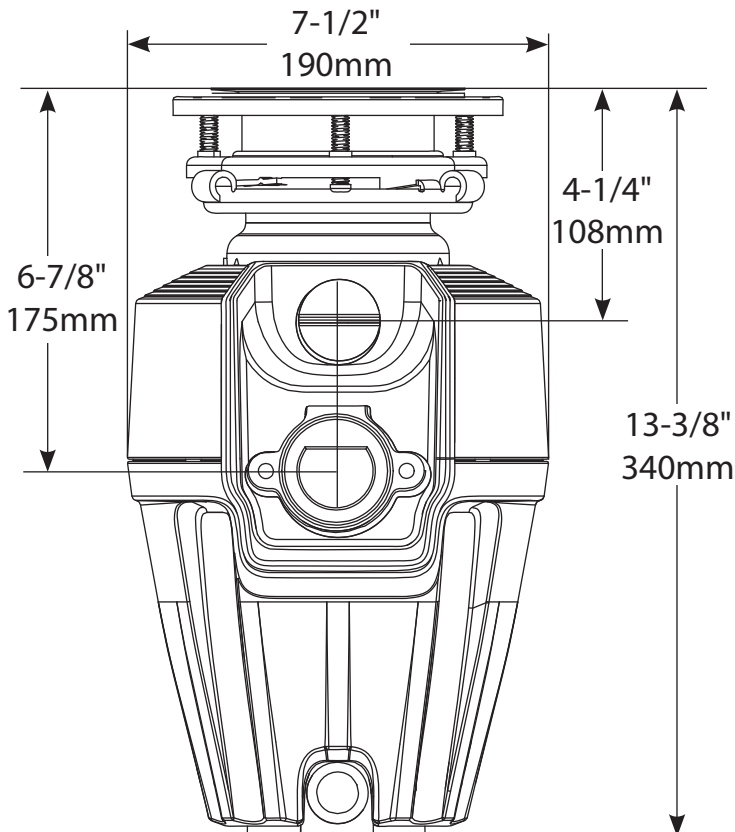

Specification Detail	
Horsepower	1/2 HP
Feed Type	Continuous
On/Off Controls	Wall Switch
Motor Type	Permanent Magnet Motor
RPM (Revolutions Per Minute)	2600
Weight	9.25 lbs/ 4.2 kg
Volts	115
Hz/Amps	60/4.5
Drain Connection Size	1 1/2" / 38mm
Dishwasher Connection Size	7/8" / 22mm
Maximum Sink Thickness	1/2" / 13mm
Sink Drain Flange Finish	Stainless Steel
Turntable Material	Stainless Steel
Grind Component Material	Galvanized Steel
Grind Chamber Material	Corrosion Proof Glass Filled Polyester and Nylon