

IN-GROUND  
FENCE

1000A

**OPERATING & TRAINING GUIDE**  
PLEASE READ THIS ENTIRE GUIDE BEFORE BEGINNING

# IMPORTANT SAFETY INFORMATION

Explanation of Attention Words and Symbols used in this guide

 This is the safety alert symbol. It is used to alert you to potential personal injury hazards. Obey all safety messages that follow this symbol to avoid possible injury or death.

**WARNING** WARNING indicates a hazardous situation which, if not avoided, could result in death or serious injury.

**CAUTION** CAUTION, used with the safety alert symbol, indicates a hazardous situation which, if not avoided, could result in minor or moderate injury.

**CAUTION** CAUTION, used without the safety alert symbol, indicates a hazardous situation which, if not avoided, could result in harm to your dog.

**NOTICE** NOTICE is used to address safe use practices not related to personal injury.

**WARNING**

- Not for use with aggressive dogs. Do not use this product if your dog is prone to aggressive behavior. Aggressive dogs can cause severe injury or death to their owners and others. If you are not sure that this product is right for your dog, please talk to your veterinarian or a certified trainer.
- Underground cables can carry high voltage. Have all underground cables marked before you dig to bury your wire. In most areas, this is a free service. Avoid these cables when you dig.
- Follow all safety instructions for your power tools. Be sure to always wear your safety goggles.
- Do not install, connect, or remove your system during a lightning storm. If the storm is close enough for you to hear thunder, it is close enough to create hazardous surges.
- Risk of electric shock. Use the Fence Transmitter indoors in a dry location only.

**CAUTION**

- Risk of injury. Wire on top of the ground may be a trip hazard. Use care in how you place your wires.
- If possible, DO NOT use an AC circuit with a GFCI (ground fault circuit interrupter). In rare cases, nearby lightning may cause the GFCI to trip. Without power to the system, your dog may escape. You will have to reset the GFCI to restore power.

**CAUTION** This SportDOG Brand® In-Ground Fence is NOT a solid barrier. The system is designed to act as a deterrent to remind dogs by stimulation to remain in the boundary established. It is important that you reinforce training with your dog on a regular basis. Since the tolerance level to stimulation varies from one dog to the next, Radio Systems® Corporation CANNOT guarantee that the system will, in all cases, keep a dog within the established boundary. Not all dogs can be trained to avoid crossing the boundary! Therefore, if you have reason to believe that your dog may pose a danger to others or harm himself if he is not kept from crossing the boundaries, you should NOT rely solely upon the SportDOG Brand In-Ground Fence to confine your dog. Radio Systems Corporation shall NOT be liable for any property damage, economic loss or any consequential damages, sustained as a result of any animal crossing the boundary.

**CAUTION** Please read and follow the instructions in this manual. Proper fit of the collar is important. A collar worn for too long or made too tight on the dog's neck may cause skin damage. Ranging from redness to pressure ulcers; this condition is commonly known as bed sores.

- Avoid leaving the collar on the dog for more than 12 hours per day.
- When possible reposition the collar on the dog's neck every 1 to 2 hours.
- Check the fit to prevent excessive pressure; follow the instructions in this manual.
- Never connect a leash to the electronic collar; it will cause excessive pressure on the contacts.
- When using a separate collar for a leash, don't put pressure on the electronic collar.
- Wash the dog's neck area and the contacts of the collar weekly with a damp cloth.
- Examine the contact area daily for signs of a rash or a sore.
- If a rash or sore is found, discontinue use of the collar until the skin has healed.
- If the condition persists beyond 48 hours, see your veterinarian.
- For additional information on bed sores and pressure necrosis, please visit the FAQ section for in-ground containment at [www.sportdog.com](http://www.sportdog.com).

These steps will help keep your dog safe and comfortable. Millions of dogs are comfortable while they wear stainless steel contacts. Some dogs are sensitive to contact pressure. You may find after some time that your dog is very tolerant of the collar. If so, you may relax some of these precautions. It is important to continue daily checks of the contact area. If redness or sores are found, discontinue use until the skin has fully healed.

You may need to trim the hair in the area of the Contact Points or switch to the longer Contact Points to ensure consistent contact. Never shave the dog's neck; this may lead to a rash or infection.

To prevent an unintended correction:

- The Collar Receiver should not be on your dog when the system is tested.
- Remove the Collar Receiver before making any changes to your system.
- Before placing the Collar Receiver on your dog, test the Boundary Area and Width after any change.

**NOTICE**

- Use care when mowing or trimming your grass not to cut the loop wire.
- For added protection, when unused for long periods of time or prior to thunderstorms, unplug from the wall outlet and disconnect the Loop Boundary Wires. This will prevent damage to the Transmitter due to surges.
- Avoid damage to the jacket of the loop wire during the install; damage may cause areas of weak signal and lead to early failure of the loop (wire breaks).

Thank you for choosing SportDOG Brand.® Used properly, this product will help you train your dog efficiently and safely. To ensure your satisfaction, please review this owner's manual thoroughly. If you have questions regarding this product's operation, please see this manual's Frequently Asked Questions or Troubleshooting section, contact our Customer Care Center at 1-800-732-0144, or visit our website at [www.sportdog.com](http://www.sportdog.com).

To get the most protection out of your warranty, please register your product within 30 days at [www.sportdog.com](http://www.sportdog.com). By registering, and keeping your receipt you will enjoy the product's full warranty and should you ever need to call the Customer Care Center, we will be able to help you faster. Most importantly, SportDOG™ will never give or sell your valuable information to anyone. Complete warranty information is available online at [www.sportdog.com](http://www.sportdog.com).

## TABLE OF CONTENTS

<b>COMPONENTS</b> .....	5
<b>OTHER ITEMS YOU MAY NEED</b> .....	5
<b>HOW THE SYSTEM WORKS</b> .....	6
<b>KEY DEFINITIONS</b> .....	6
<b>OPERATING GUIDE</b>	
<b>LOCATE THE FENCE TRANSMITTER</b> .....	7
<b>LAY OUT THE SYSTEM</b> .....	7
<b>SAMPLE LAYOUTS</b> .....	8
<b>POSITION THE BOUNDARY WIRE</b> .....	9
<b>CONNECT THE WIRES TO THE FENCE TRANSMITTER</b> .....	10
<b>PREPARE THE COLLAR RECEIVER</b> .....	12
<b>SET THE BOUNDARY WIDTH AND TEST THE COLLAR RECEIVER</b> .....	13
<b>INSTALL THE BOUNDARY WIRE</b> .....	14
<b>PLACE THE BOUNDARY FLAGS</b> .....	16
<b>FIT THE COLLAR RECEIVER</b> .....	16
<b>TRAINING GUIDE</b>	
<b>BE PATIENT WITH YOUR DOG</b> .....	17
<b>DAY 1 - BOUNDARY FLAG AWARENESS</b> .....	17
<b>DAYS 2 THRU 4 - CONTINUE BOUNDARY FLAG AWARENESS</b> .....	18
<b>DAYS 5 THRU 8 - DISTRACTION PHASE</b> .....	18
<b>DAYS 9 THRU 14 - UNLEASHED SUPERVISION</b> .....	19
<b>DAYS 15 THRU 30 - MONITORING YOUR DOG</b> .....	19
<b>TAKING YOUR DOG OUT OF THE BOUNDARY AREA</b> .....	19
<b>ACCESSORIES</b> .....	20
<b>FREQUENTLY ASKED QUESTIONS</b> .....	21
<b>TROUBLESHOOTING</b> .....	22
<b>ADDITIONAL INFORMATION</b> .....	23
<b>SHORT LOOP TEST</b> .....	23
<b>TO LOCATE A BREAK IN THE BOUNDARY WIRE</b> .....	24
<b>TERMS OF USE AND LIMITATION OF LIABILITY</b> .....	24
<b>COMPLIANCE</b> .....	25
<b>CUSTOMER CARE INTERNATIONAL</b> .....	25
<b>LAYOUT GRID</b> .....	26
<b>MOUNTING TEMPLATE</b> .....	27

## COMPONENTS



## OTHER ITEMS YOU MAY NEED

- Additional wire and flags (Part# SDF-WF ), includes 500 feet of wire and 50 boundary flags
- Measuring Tape
- Drill & mounting hardware
- Shovel or lawn edger
- Pliers
- Wire stripping pliers
- Scissors
- Additional wire nuts
- Ground rod and clamp
- PVC pipe or water hose
- Circular saw with masonry blade for burying wire in hard surfaces
- Patching compound
- Staple gun
- Non-metallic collar and leash

*NOTE: For information on professional installation of your new SportDOG Brand® In-Ground Fence System, contact the Customer Care Center at 1-800-732-0144.*

# HOW THE SYSTEM WORKS

The SportDOG Brand® In-Ground Fence System has been proven safe, comfortable, and effective for dogs over 10 pounds. The system works by producing a radio signal from the Fence Transmitter through up to 8,600 feet of Boundary Wire. The Boundary Wire is buried or attached to a fixed object to enclose the dog's Boundary Area. You temporarily define the Boundary Area with Boundary Flags for a visual aid in training your dog. Your dog wears a Collar Receiver with Contact Points that touch his neck and, once trained, is allowed to roam freely in the Boundary Area. When your dog reaches the Warning Zone, the Collar Receiver gives a warning beep. If your dog continues into the Stimulation Zone, a safe stimulation will be delivered through the Contact Points to get his attention until he returns to the Boundary Area.

## KEY DEFINITIONS

**FENCE TRANSMITTER:** The power source that transmits the radio signal through the Boundary Wire.

**BOUNDARY AREA:** The area inside the Warning Zone where your dog can roam freely.

**WARNING ZONE:** The perimeter of the Boundary Area where your dog's Collar Receiver begins to beep, warning him not to go into the Stimulation Zone.

**STIMULATION ZONE:** The zone beyond the Warning Zone where your dog's Collar Receiver will deliver a Stimulation, signaling him to return to the Boundary Area.

**BOUNDARY WIDTH:** The area covered by the Warning Zone and the Stimulation Zone.

**STIMULATION MODE SWITCH:** Used to select the type of stimulation delivered by the Collar Receiver.

**RANGE SWITCH:** The switch to adjust the Boundary Area according to the length of Boundary Wire used.

**POWER JACK:** The jack where the Power Adapter plugs into the Fence Transmitter. The Fence Transmitter is powered by a standard electrical outlet.

**RANGE ADJUSTER:** The knob that adjusts the width of the Warning and Stimulation Zones. *NOTE: Adjusting the knob does not change the level of Stimulation on the Collar Receiver.*

**LOOP INDICATOR LIGHT:** The light that indicates that the Boundary Wire makes a complete loop, enabling the signal to be transmitted.

**GROUND TERMINAL:** The terminal where the ground wire connects to the Fence Transmitter.

**BOUNDARY WIRE TERMINALS:** The terminals where the Boundary Wires connect to the Fence Transmitter in order to complete a continuous loop.

**7K/10K FREQUENCY SWITCH:** Make sure switch is set to 10K setting. If you are experiencing interference contact Customer Care.

**COLLAR RECEIVER:** Receives the radio signal from the Boundary Wire. The Collar Receiver is waterproof.

**RECEIVER INDICATOR LIGHT:** The light that indicates the Stimulation Level at which the Collar Receiver is set. This light also serves as a low-battery indicator.

**STIMULATION LEVEL BUTTON:** The button to adjust the level of Stimulation your dog receives in the Stimulation Zone.

**CONTACT POINTS:** The contacts through which the Collar Receiver delivers Stimulation when your dog moves into the Stimulation Zone.

### HOW THE SYSTEM WORKS

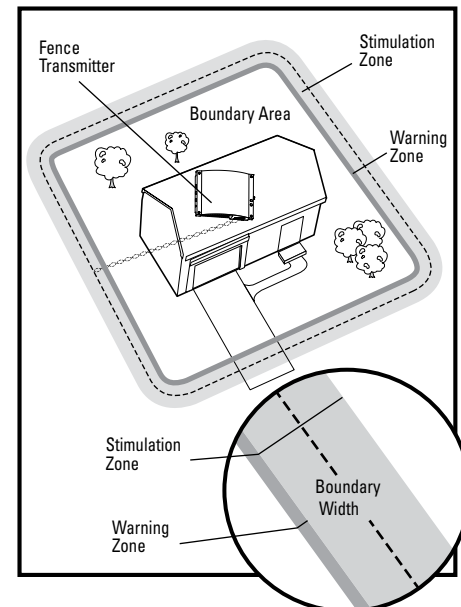

### COLLAR RECEIVER

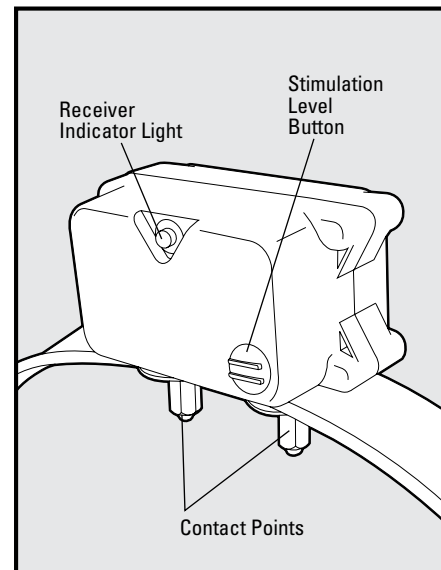

### FENCE TRANSMITTER

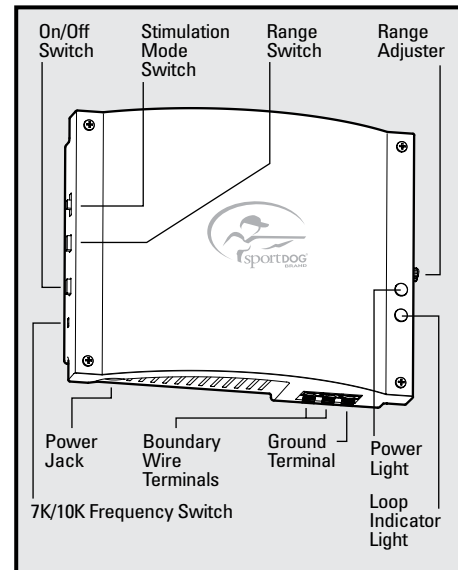

# OPERATING GUIDE

## STEP :: 01

## LOCATE THE FENCE TRANSMITTER

Place the Fence Transmitter:

- In a dry, well ventilated, protected area (1A).
- In an area out of the weather (garage, basement, shed, closet).
- Secured to a stationary surface using appropriate mounting hardware (not included). A mounting template is included on page 27 of this guide.
- At least 3 feet from large metal objects or appliances as these items may interfere with the signal consistency (1B).
- As close as possible to you home's Grounding Electrode. This is required to keep the Ground Wire as short as possible.

Once you have mounted the Fence Transmitter, the Boundary Wire must exit the building. This can be accomplished via a window or through a 1/8" hole drilled through the wall. Ensure the drill path is clear of any utilities. Make sure the Boundary Wire is not cut off or pinched by a window, door, or garage door, as this can damage it over time.

To prevent fires and electrical hazards, install the Fence Transmitter in buildings that are in accordance with state and local electrical and building codes.

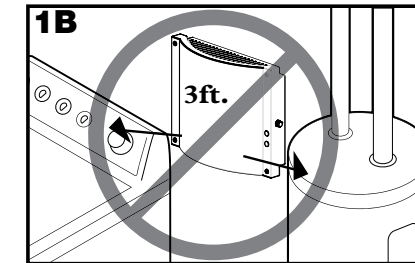
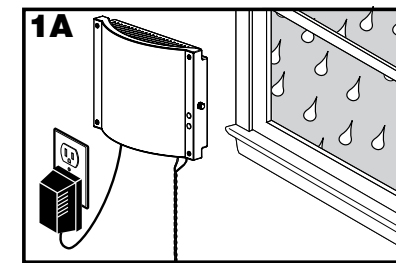

## STEP :: 02

## LAY OUT THE SYSTEM

### BASIC PLANNING TIPS

**⚠ WARNING** Underground cables can carry high voltage. Have all underground cables marked before you dig to bury your wire. In most areas, this is a free service. Avoid these cables when you dig.

- The Boundary Wire **MUST** start at the Fence Transmitter and make a continuous loop back (2A).
- Design a layout that is suitable for your yard. Sample layouts are provided on the following page, and a grid for designing your layout is provided on page 26.
- Always use gradual turns at the corners to produce a more consistent boundary (2B). Do not use sharp turns, as this will cause gaps in your boundary.
- We recommend setting a Boundary Width for the Warning and Stimulation Zones to approximately 16 - 24 feet (8 - 12 feet on each side of the wire).

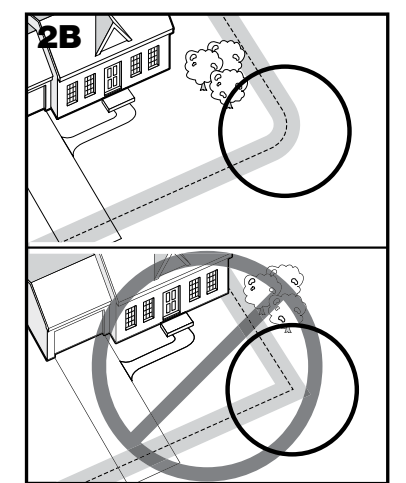
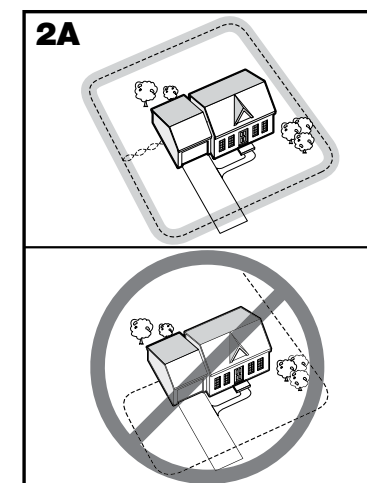

- The Collar Receiver can be activated inside the house if the Boundary Wire runs along the outside wall of the house. If this occurs, remove your dog's Collar Receiver before bringing him inside, decrease the range using the Range Adjuster or consider an alternative layout.

# SAMPLE LAYOUTS

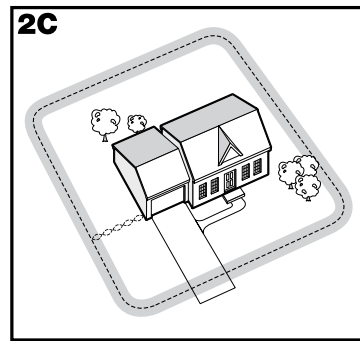

**Sample 1: Perimeter Loop (Single Loop)**  
The Perimeter Loop is the most common layout. This will allow your dog to freely and safely roam your entire property (2C). It can also protect gardens, pools and landscaping (2D).

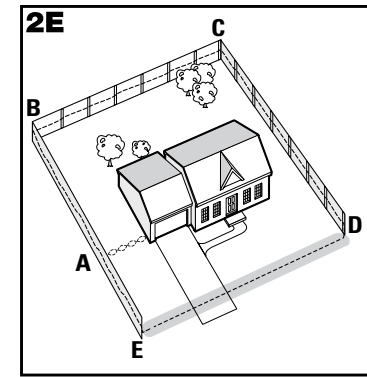
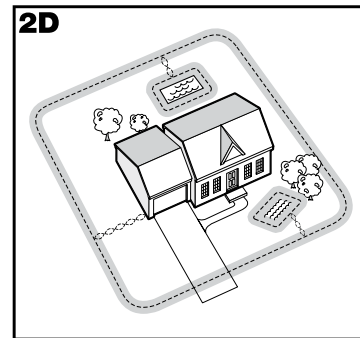

**Sample 2 (2E): Perimeter Loop Using Existing Fence (Single Loop)**  
This layout allows you to include your existing fence as part of your layout and keeps your dog from jumping out or digging under it. It reduces the amount of wire which will need to be buried. From the Fence Transmitter, run the wire to **A**, **A** to **B**, **B** to **C**, **C** to **D**, **D** to **E**, **E** to **A**, twisting the wires from **A** back to the Fence Transmitter. See the "Install the Boundary Wire" section for more information on attaching the wire to a fence (pages 14-15).

## DOUBLE LOOP (2F, 2G, 2H, 2J)

A Double Loop must be used when you are not establishing the Boundary Area on all sides of your property.

When using a Double Loop, the Boundary Wire must be separated by a minimum of THREE TO FIVE FEET to avoid canceling the signal. Remember that a Double Loop will require twice as much wire.

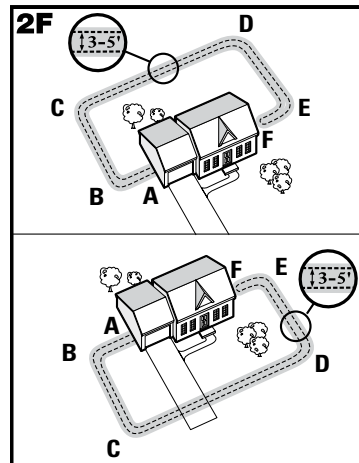

**Sample 3: Front or Back Yard Only (Double Loop)**  
From the Fence Transmitter, run the wire to **A**, **A** to **B**, **B** to **C**, **C** to **D**, **D** to **E**, **E** to **F**, make a U-turn and follow your path all the way back to **A**, keeping the wire separated three to five feet. Twist the wire from **A** back to the Fence Transmitter.

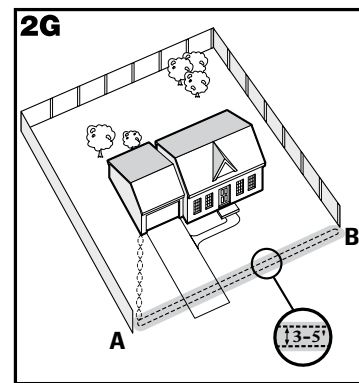

**Sample 4: Front Boundary Only (Double Loop)**  
From the Fence Transmitter, run the wire to **A**, **A** to **B**, **B** back to **A** keeping the wire separated three to five feet. Twist the wire from **A** back to the Fence Transmitter.

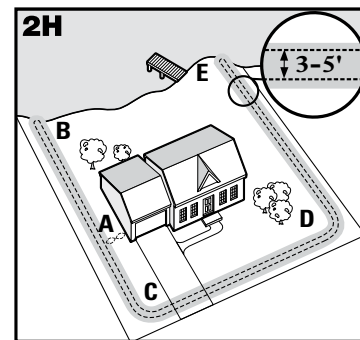

**Sample 5: Lake Access (Double Loop)**  
From the Fence Transmitter, run the wire to **A**, **A** to **B**, make a U-turn and go to **C**, **C** to **D**, **D** to **E**, make a U-turn and follow your path all the way back to **A** keeping wire separated three to five feet. Twist the wire from **A** back to the Fence Transmitter.

**Sample 6: Wire Loop Attached to Existing Fence (Double Loop)**  
This layout allows you to include your existing fence as part of your layout and keeps your dog from jumping out or digging under it. It reduces the amount of wire which will need to be buried. Run the wire from the Fence Transmitter to **A**, **A** to **B**, **B** to **C**, **C** to **D**, **D** to **E**, **E** to **F**, make a U-turn and follow your path all the way back to **A**, keeping the wire separated three to five feet. Twist the wire from **A** back to the Fence Transmitter. See the "Install the Boundary Wire" section for more information on attaching the wire to a fence (pages 14-15).

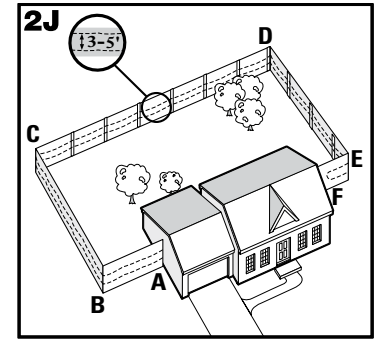

## STEP :: 03

## POSITION THE BOUNDARY WIRE

Lay out the Boundary Wire using your proposed boundary, and test the system **BEFORE** burying the wire or attaching it to an existing fence. This will make any layout changes easier. Work carefully, a nick in the wire insulation can diminish the signal strength and create a weak area where your dog can escape.

Running the Boundary Wire parallel to and within five feet of electrical wires, neighboring containment systems, telephone wires, television or antenna cables, or satellite dishes will cause an inconsistent signal. If you must cross any of these, do so at 90-degree angles (perpendicularly).

If separating your Boundary Wire by at least five feet from a neighboring containment system's wire does not reduce the inconsistent signal, contact the Customer Care Center at 1-800-732-0144.

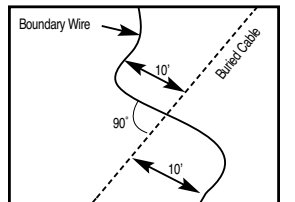

## TO TWIST THE BOUNDARY WIRE (3A)

Twisting the Boundary Wire cancels the signal and allows your dog to cross over that area without receiving a correction. To ensure the signal is cancelled, it is recommended that you cut and splice the Boundary Wire between each twisted section. The signal cannot be cancelled by running the wire through plastic or metal piping. Splicing shielded cable to the Boundary Wire will also not cancel the signal. Refer to figure on the right for the correct method for twisting the wire. You can twist your own wire by cutting two equal lengths of Boundary Wire supplied and twisting them together. Anchor one end of the wires to something secure and insert the other end in a power drill. Pull the wire taut. The drill enables you to twist the wire quickly. Twist the Boundary Wire 10 to 12 times per foot to cancel the signal. Once you have completed your boundary layout, insert the twisted wire into the transmitter.

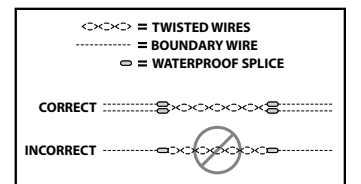

## TO SPLICE OR REPAIR THE BOUNDARY WIRE (3B)

If you need additional Boundary Wire to expand your wire loop, you will need to splice the wires together. Note the locations of all splices for future reference. Most Boundary Wire breaks occur at splices.

Strip approximately one-half inch of insulation off the ends of the Boundary Wires to be spliced. Make sure the copper Boundary Wire is not corroded. If the Boundary Wire is corroded, cut it back to expose clean copper wire.

Insert the stripped ends into the wire nut and twist the wire nut around the wires. Pull on the wires to make sure you have a strong splice connection. If your splice pulls loose, the entire system will fail. Make sure your splice is secure. For extra protection, Waterproof Wire Nut Covers have been included. Insert the splice and push the wire nut to the bottom, making sure the gel covers any exposed wire. Latch the Waterproof Wire Nut Cover securely (3C).

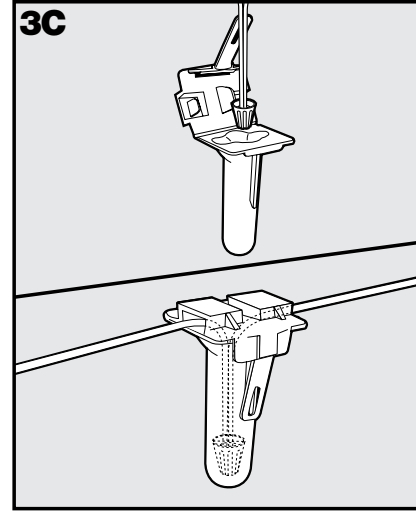
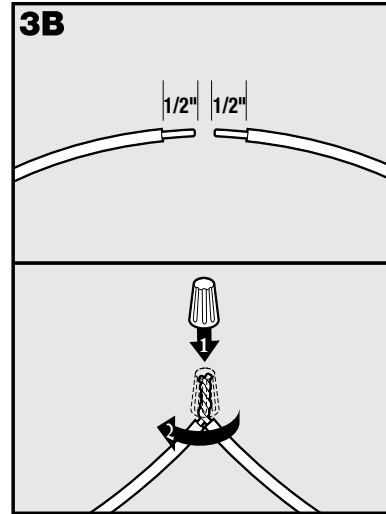
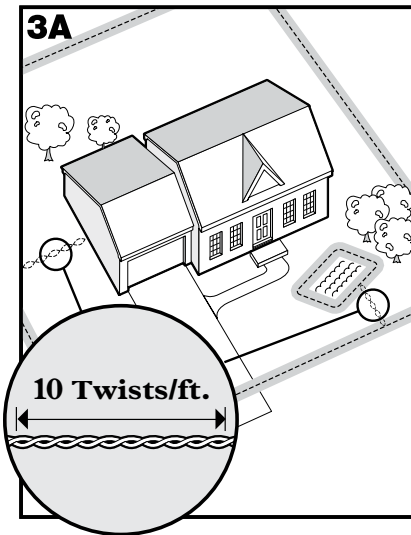

### ADDITIONAL BOUNDARY WIRE

We recommend the use of 20 gauge insulated solid copper wire for direct burial. Extra Boundary Wire can be purchased in 500 foot spools at the store where you purchased the kit or through the Customer Care Center at 1-800-732-0144.

*NOTE: When adding Boundary Wire, it must act as a continuous loop.*

The table at right indicates the approximate length of Boundary Wire needed for a rectangular, Single Loop layout. Length will vary due to the amount of twisted wire and layout used.

Acres	Feet of Wire Needed
1/4	415
1/3	480
1/2	590
1	835
2	1180
5	1870
10	2800
20	3750
30	4600
40	5330
50	5900
60	6500
70	7000
80	7500
90	8000
100	8350

4. Plug the Power Adapter into the Power Jack and an electrical outlet.
5. The Power Light and Loop Indicator Lights should come on. If this does not happen, see the "Troubleshooting" section (page 22).

### GROUND WIRE (4B)

Proper grounding, although not necessary for the system to work, will help reduce the chance of electrical surges causing damage to your Fence Transmitter and/or Power Adapter. To ground your unit, you will need a solid (not stranded) Ground Wire (14 to 18 gauge insulated copper wire) and an appropriate Listed clamp, which may be obtained at most home improvement and electrical supply stores. Connect one end of the Ground Wire to the Ground Terminal located on the Fence Transmitter and the other end of the Ground Wire to your home's Grounding Electrode. The Ground Wire must be as short as possible and routed using the least number of bends possible. When routing the Ground Wire, sharp ninety degree bends should be avoided, swept bends are preferred. If you are uncertain about how best to connect the Ground Wire, consult a local licensed electrician.

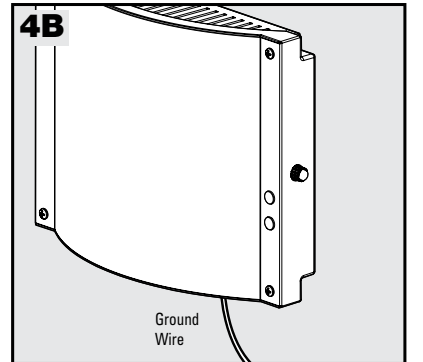

### FUSE PROTECTION (4C)

The Fence Transmitter is also equipped with two 250 volt, 1 amp fuses to protect the unit's electronic circuitry from electrical power surges. To locate the fuses, remove the 4 screws from the back of the Fence Transmitter.

### SURGE PROTECTION (USA & CANADA)

You may purchase a Surge Protection Kit (LP-4100) through the Customer Care Center at 1-800-732-0144. The Surge Protection Kit protects the system against surges that travel through the power source and/or the Boundary Wire. If you use a Surge Protection Kit, the Ground Wire must be removed from the Fence Transmitter. The Surge Protection Kit utilizes a ground connection separate from the Fence Transmitter.

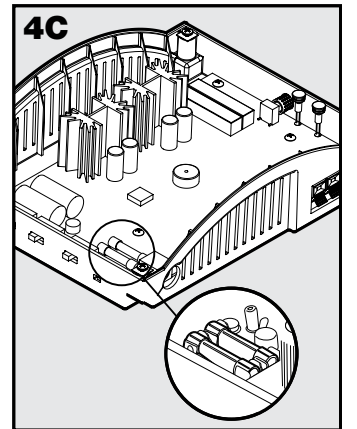

## STEP :: 04 CONNECT THE WIRES TO THE FENCE TRANSMITTER

### ⚠ WARNING

- Do not install, connect, or remove your system during a lightning storm. If the storm is close enough for you to hear thunder, it is close enough to create hazardous surges.
- Risk of electric shock. Use the Fence Transmitter indoors in a dry location only.

### NOTICE

For added protection, when unused for long periods of time or prior to thunderstorms, unplug from the wall outlet and disconnect the Loop Boundary Wires. This will prevent damage to the Transmitter due to surges.

### BOUNDARY WIRE (4A)

1. Run the Boundary Wire to the Fence Transmitter through a window, under a door, through a crawl space vent, or any other appropriate available access. You can also drill a 1/8" hole through your wall.
2. Strip the ends of the Boundary Wire approximately one-half inch.
3. Insert the Boundary Wires into the Boundary Wire Terminals on the Fence Transmitter.

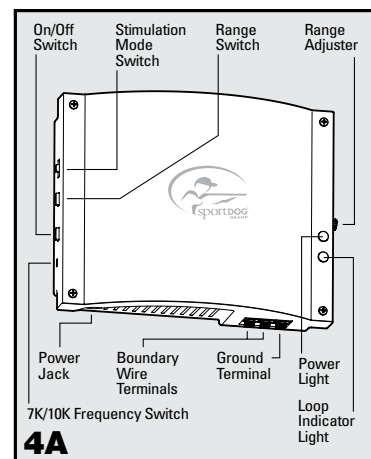

# STEP :: 05

## PREPARE THE COLLAR RECEIVER

Your Collar Receiver comes with short Contact Points installed. If your dog has a long or thick coat, you have two options to ensure consistent contact: either trim the hair around the Contact Points or switch to the longer Contact Points included with your system (follow 1-5 in diagram 5A). Tighten the Contact Points with pliers one-half turn beyond finger tight. Check the tightness weekly.

### TO INSERT AND REMOVE THE BATTERY

*NOTE: Do not install the battery while the Collar Receiver is on your dog.*

1. Remove the screws with a Philips screwdriver (5B).
2. Remove the Battery Lid (5B).
3. Install a 9-volt alkaline battery (5C).
4. Replace the Battery Lid (5C). Ensure o-ring stays in place.
5. Reinstall the screws. Do not over-tighten the screws.

Replacement 9-volt alkaline batteries can be found at many retailers.

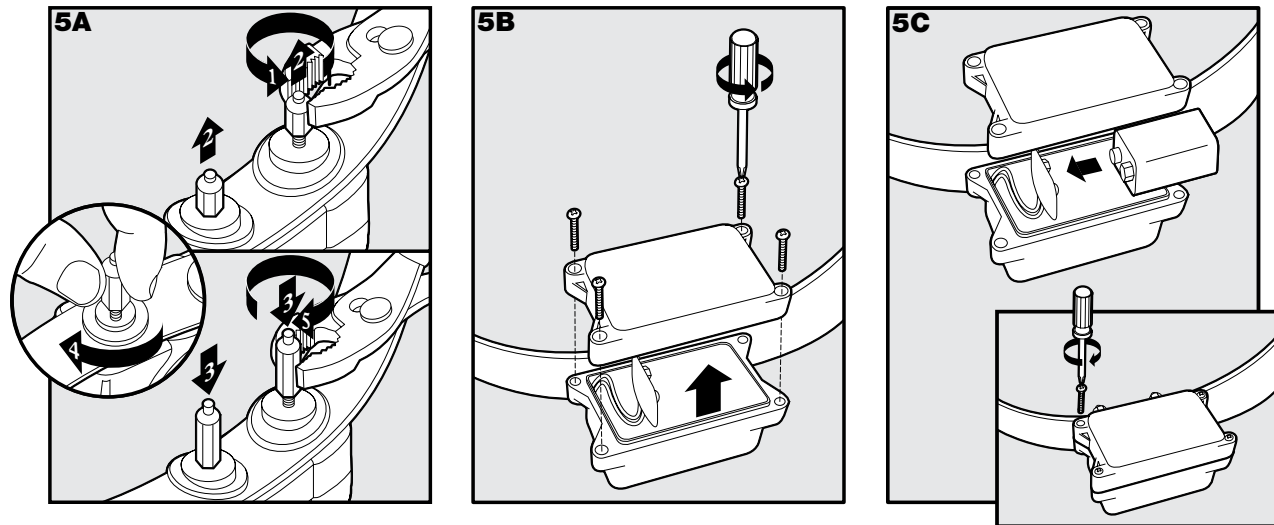

### TO SET THE STIMULATION LEVEL

Read all steps before attempting to set the Stimulation Level.

1. Remove the clear plastic cover with a coin to expose the Stimulation Level Button (5D).
2. With the battery installed, press the Stimulation Level Button and release when the Receiver Indicator Light lights up (5E).
3. The Receiver Indicator Light will emit a series of flashes representing the Stimulation Level. For example, 2 flashes = Stimulation Level 2.
4. Increase the Stimulation Level by pressing and releasing the Stimulation Level Button within 5 seconds of the previous series of flashes.
5. After setting the Stimulation Level, replace the cover to protect the Stimulation Level Button.

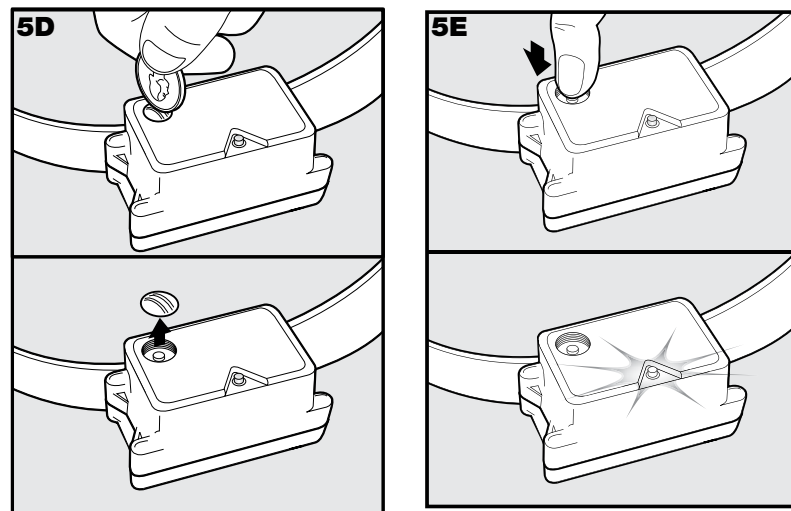

The Stimulation Levels increase in strength from 1 to 5. Pushing the Stimulation Level Button while the Collar Receiver is on level 5 will cause the Collar Receiver to go back to level 1. Refer to the Function and Response Table, on the following page, to choose the Stimulation Level that best fits your dog.

The Collar Receiver is equipped to automatically increase the level of Stimulation the longer your dog remains in the Stimulation Zone if the collar is set at level 2 or above.

The Receiver Indicator Light acts as a low battery indicator, flashing every 4 to 5 seconds when a replacement is required.

## FUNCTION AND RESPONSE TABLE

Indicator Light Response	Stimulation Level	Collar Receiver Function	Temperament of Dog
1 Flash	1	Beep and Vibrate (No Stimulation)	
2 Flashes	2	Low Stimulation	Timid
3 Flashes	3	Medium Stimulation	Timid or Average
4 Flashes	4	Medium High Stimulation	Average or Stubborn
5 Flashes	5	High Stimulation	Stubborn
Flashes once every 4 to 5 seconds		Low Battery	

*NOTE: Begin training with Stimulation Level 2 and only increase if your dog does not respond to the Stimulation.*

⚡ = Beep and Vibration Only   ⚡ + ⚡ = Beep, Vibration and Stimulation   ⚡ = Stimulation Only

**Important:** The Stimulation Mode Switch (5F) can alter the response of the Collar Receiver. When this Stimulation Mode Switch is set to "⚡" or "⚡ + ⚡", the Collar Receiver will respond according to the Function and Response Table above. However, if the Stimulation Mode Switch is set to "⚡", this setting will override the Stimulation Level 1 function. In this case, no Stimulation will be delivered, and the Collar Receiver will NOT beep or vibrate; it will only make the ticking sound that normally indicates Stimulation. We recommend to leave the Stimulation Mode Switch on the "⚡" or "⚡ + ⚡" settings.

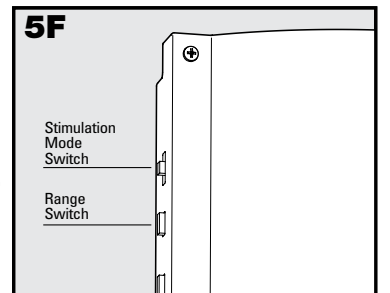

# STEP :: 06

## SET THE BOUNDARY WIDTH AND TEST THE COLLAR RECEIVER

The Range Switch on the side of the Fence Transmitter has two settings. Set the Range Switch to LOW if the amount of wire used for your property is less than 4,400 feet. Set the Range Switch to HI if you used between 4,400 and 8,600 feet of wire.

Use the Range Adjuster knob to set the width of the Warning Zone and Stimulation Zone (6A). Set the Boundary Width as wide as possible to give your dog the widest Warning and Stimulation Zones without reducing the Boundary Area too much.

*NOTE: The Range Adjuster knob does not change the Stimulation Level.*

**CAUTION** The Receiver Collar should NOT be on your dog when the system is tested. Your dog may receive an unintended correction.

To identify the Warning and Stimulation Zones, make sure the Collar Receiver's battery is properly installed, the Stimulation Level is set at 2 or above, and the Test Light contacts are held to the Contact Points (6B). Walk toward the Boundary Wire holding the Collar Receiver at your dog's neck level (6C) until the Receiver Collar beeps (6D).

*NOTE: The Collar Receiver is waterproof, which can make the beep hard to hear.*

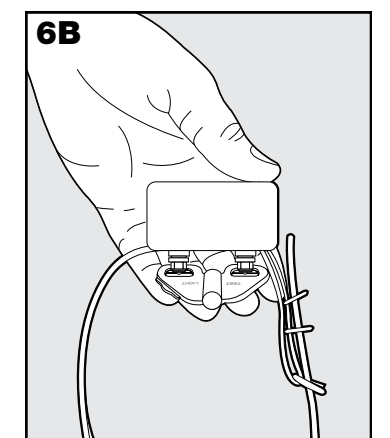
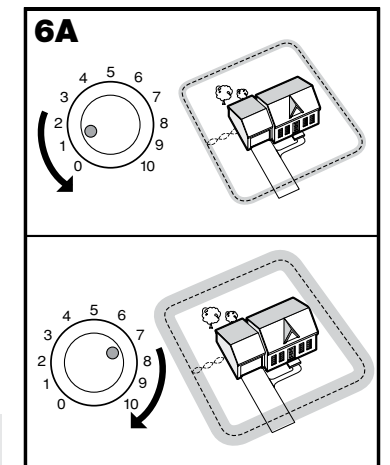

**CAUTION**

To prevent an unintended correction for your dog, test the Boundary Area and Width after any change.

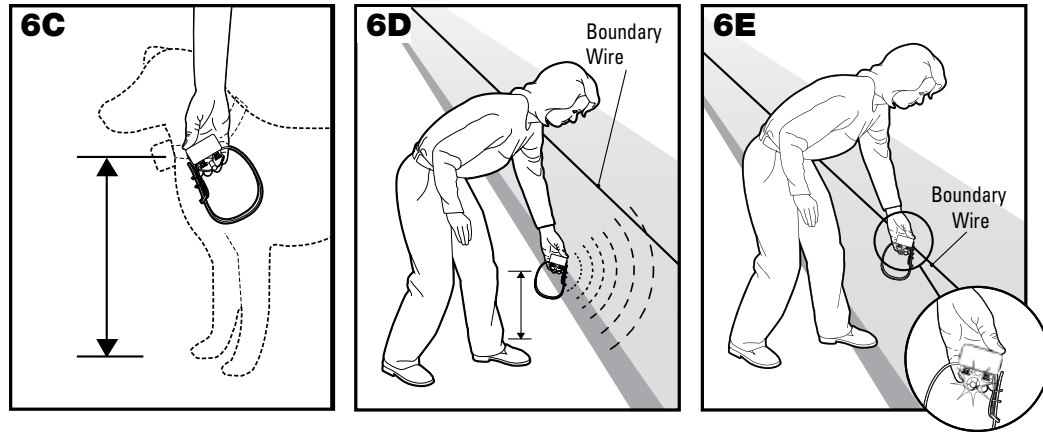

If the Collar Receiver does not beep at the desired range, adjust the Range Adjuster knob to the desired setting. Turning the Range Adjuster knob clockwise increases the Boundary Width while turning it counterclockwise decreases it. Repeat this activity as needed until the Collar Receiver beeps at the desired distance from the Boundary Wire.

The numbers on the Range Adjuster knob indicate signal strength and are not representative of Boundary Width footage. If adjusting the Range Adjuster knob does not give the desired range, adjust the Range Switch to the other setting to achieve your desired range. If using a Double Loop, you may need to increase the separation of the Boundary Wire to achieve the desired range.

The Collar Receiver beeps as a warning tone and ticks when delivering a Stimulation. After hearing the beep, continue to walk towards the wire. The Collar Receiver should tick and the Test Light should flash, indicating the Stimulation as you enter the Stimulation Zone (6E). A warning beep and the flashing of the Test Light indicate that the Collar Receiver and the system are working properly and that you are ready to start burying the Boundary Wire. If the Collar Receiver did not beep or the Test Light did not flash, refer to the "Troubleshooting" section on page 22.

*NOTE: The Boundary Width is broken down into 20% Warning Zone and 80% Stimulation Zone.*

## INSTALL THE BOUNDARY WIRE

### ⚠ WARNING

- Underground cables can carry high voltage. Have all underground cables marked before you dig to bury your wire. In most areas, this is a free service. Avoid these cables when you dig.
- Before you begin installing the Boundary Wire, turn the Fence Transmitter OFF.

### TO BURY THE BOUNDARY WIRE

Burying the Boundary Wire is recommended to protect it and prevent disabling the system.

1. Cut a trench 1-3 inches deep along your planned boundary.
2. Place the Boundary Wire into the trench maintaining some slack to allow it to expand and contract with temperature variations.
3. Use a blunt tool such as a wooden paint stick to push the Boundary Wire into the trench, being careful not to damage the Boundary Wire.

### TO ATTACH THE BOUNDARY WIRE TO AN EXISTING FENCE

The Boundary Wire of the SportDOG Brand® In-Ground Fence System can be attached to a chain link fence, split rail fence, or a wooden privacy fence. The Boundary Wire can be attached as high as needed. However, make sure the Boundary Width is set at a high enough range for the dog to receive the signal. If using a Double Loop with an existing fence at least three feet tall, run the Boundary Wire on top of the fence and return it on the bottom of the fence to get the three to five foot separation needed.

- Chain Link Fence (7A): Weave Boundary Wire through the links or use plastic quick ties.
- Wooden Split Rail or Privacy Fence (7A): Use staples to attach Boundary Wire. Avoid puncturing the insulation of the Boundary Wire.
- Double Loop with an Existing Fence: Run Boundary Wire on top of the fence and return it on the bottom of the fence to get the three to five foot separation needed.
- Gate (Single Loop) (7B): Bury the Boundary Wire in the ground across the gate opening. Note: The signal is still active across the gate. Your dog cannot pass through an open gate.
- Gate (Double Loop) (7B): Bury both Boundary Wires across the gate opening while keeping them three to five feet apart.

**⚠ WARNING** Follow all safety instructions for your power tools. Be sure to always wear your safety goggles.

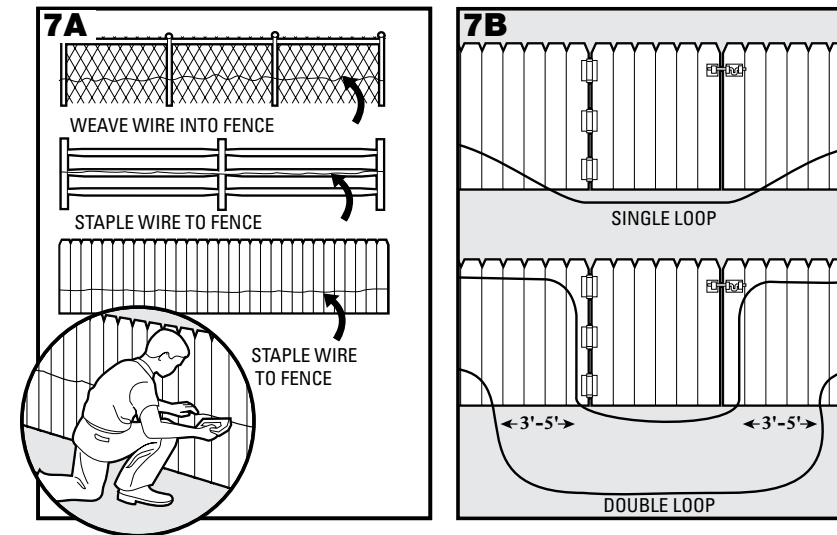

### TO CROSS HARD SURFACES (DRIVEWAYS, SIDEWALKS, ETC.)

- Concrete Driveway or Sidewalk (7C): Place the Boundary Wire in a convenient expansion joint or create a groove using a circular saw and masonry blade. Place the Boundary Wire in the groove and cover with an appropriate patching compound. For best results, brush away dirt or other debris before patching.
- Gravel or Dirt Driveway (7D): Place the Boundary Wire in a PVC pipe or water hose to protect the Boundary Wire before burying.

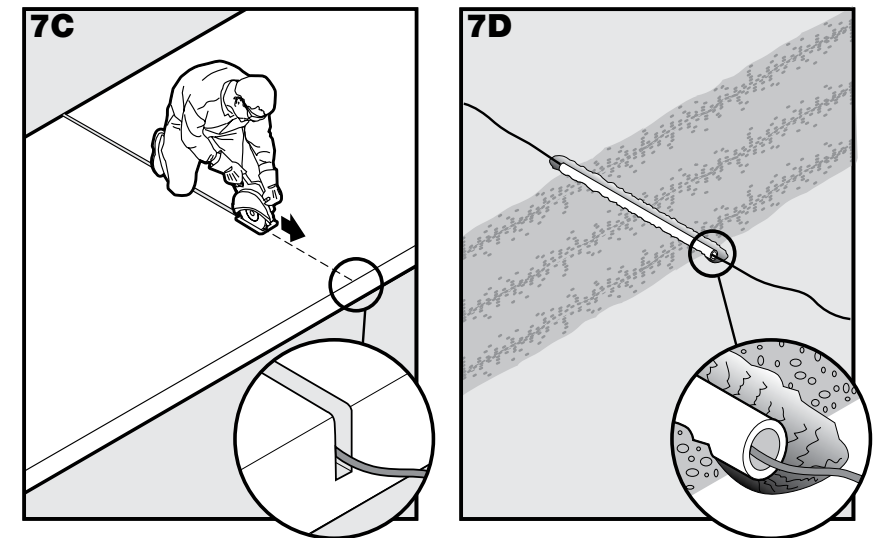



## PLACE THE BOUNDARY FLAGS

The Boundary Flags are visual reminders for your dog to show where the Warning Zone is located.

1. Hold the Collar Receiver at your dog's neck height.
2. Walk towards the Warning Zone until the Collar Receiver beeps (8A).
3. Place a Boundary Flag in the ground (8B).
4. Walk back into the Boundary Area until the beeping stops.
5. Repeat this process around the Warning Zone until it is marked with Boundary Flags every 10 feet.

*NOTE: If you cannot hear the beep, see the Test Light Instructions in Step 6.*

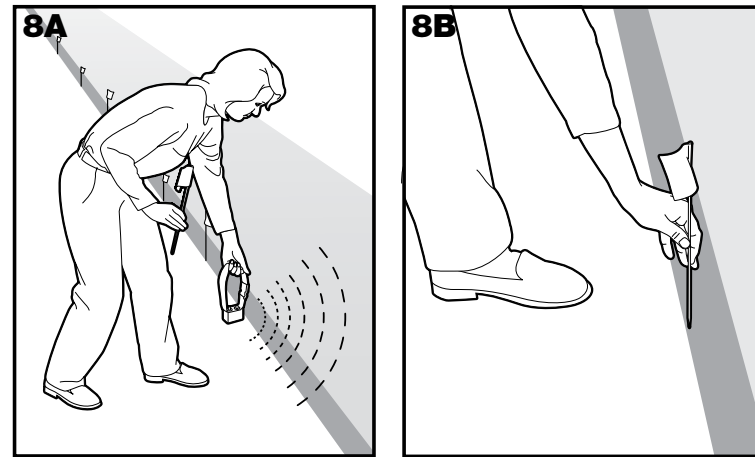

## FIT THE COLLAR RECEIVER

**IMPORTANT:** The proper fit and placement of the Collar Receiver is important for effective training. The Contact Points must have direct contact with your dog's skin.

**CAUTION** Please read and follow the instructions in this manual. Proper fit of the collar is important. A collar worn for too long or made too tight on the dog's neck may cause skin damage. Ranging from redness to pressure ulcers; this condition is commonly known as bed sores.

- Avoid leaving the collar on the dog for more than 12 hours per day.
- When possible reposition the collar on the dog's neck every 1 to 2 hours.
- Check the fit to prevent excessive pressure; follow the instructions in this manual.
- Never connect a leash to the electronic collar; it will cause excessive pressure on the contacts.
- When using a separate collar for a leash, don't put pressure on the electronic collar.
- Wash the dog's neck area and the contacts of the collar weekly with a damp cloth.
- Examine the contact area daily for signs of a rash or a sore.
- If a rash or sore is found, discontinue use of the collar until the skin has healed.
- If the condition persists beyond 48 hours, see your veterinarian.
- For additional information on bed sores and pressure necrosis, please visit the FAQ section for In-Ground Containment at [www.sportdog.com](http://www.sportdog.com).

These steps will help keep your dog safe and comfortable. Millions of dogs are comfortable while they wear stainless steel contacts. Some dogs are sensitive to contact pressure. You may find after some time that your dog is very tolerant of the collar. If so, you may relax some of these precautions. It is important to continue daily checks of the contact area. If redness or sores are found, discontinue use until the skin has fully healed.

To ensure a proper fit, follow these steps:

1. Turn power OFF at the Fence Transmitter.
2. With your dog standing (9A), center the Collar Receiver so the Contact Points are underneath your dog's neck, touching the skin (9B). If your dog has a long or thick coat, you have two options to ensure consistent contact: either trim the hair around the Contact Points or switch to the longer Contact Points included with your system.

**CAUTION** You may need to trim the hair in the area of the Contact Points. Never shave the dog's neck; this may lead to a rash or infection.

3. The Collar Receiver should fit snugly, yet loose enough to allow one finger to fit between the strap and your dog's neck (9C).
4. Allow your dog to wear the collar for several minutes, and then recheck the fit. Check the fit again as your dog becomes more comfortable wearing the Collar Receiver.

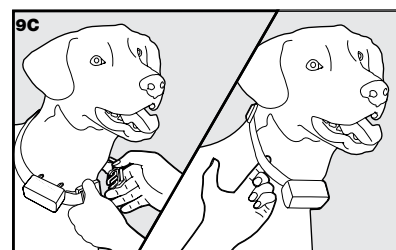
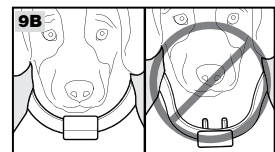
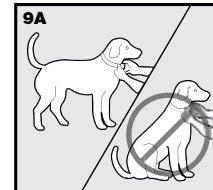

## TRAINING GUIDE

### BE PATIENT WITH YOUR DOG

**Important:** Proper training of your dog is essential to the success of the SportDOG Brand® In-Ground Fence System. Read this section completely before beginning to train your dog. Remember that the SportDOG Brand In-Ground Fence System is not a solid barrier.

- Have fun with your dog throughout the training process. Training should be fun, fair, firm and consistent.
- Train for 10 to 15 minutes at a time. Don't try to do too much too quickly. More-frequent short sessions are better than less-frequent longer sessions.
- If your dog shows signs of stress, slow down the training schedule, add additional days of training, or increase the amount of play time with your dog in the Boundary Area. Common stress signals include:
  - Dog pulling on leash toward the house
  - Ears tucked
  - Tail down
  - Body lowered
  - Nervous / frantic movement or stiffening of dog's body
- Your dog must be completely comfortable near the Boundary Flags at the end of every training session. Spend at least 5 minutes of "play time" at the completion of each session within 10 feet of the Boundary Flags.
- Finish each training session on a positive note with lots of praise and play.
- Remove the Collar Receiver after each training session.
- Be sure to contain your dog by another means during the training period (pen, tie-out, leash, etc.).
- During training, if you need to take your dog out of the Boundary Area, remove the Collar Receiver and either pick your dog up or put him in the car to pass out of the Boundary Area.
- Even if you think your dog is responding well to the training, complete the entire training. Reinforcement is important!

### DAY 1 - BOUNDARY FLAG AWARENESS

Perform three sessions on day 1, each training session lasting 10-15 minutes.

#### GOAL:

To have your dog learn that the Boundary Flags and warning beep from the Collar Receiver define the new Boundary Area.

#### SETUP:

- Begin training with Stimulation Level 2 and only increase if your dog does not respond to the Stimulation.
- Put a separate non-metallic collar on your dog's neck ABOVE the Collar Receiver and attach a leash.

**CAUTION** Be sure the extra collar does not put pressure on the Contact Points.

- Have tiny pieces of treats that your dog will find desirable available.
- Have your dog's favorite play toy available.

#### STEPS:

1. Begin by walking your dog on a leash in the Boundary Area. Calmly praise and talk to your dog, occasionally giving treats.
2. Move toward the Boundary Flags (10A). Keep your mood happy and throw treats to the ground.
3. With full control of your dog on a leash, toss a treat on the outside edge of the flags. As your dog enters the Stimulation Zone to receive the treat, he will begin to receive a mild Stimulation (10B). The longer your dog remains in the Stimulation Zone, the stronger the Stimulation will get. Allow him to stay in the Stimulation Zone for 2 seconds then gently help your dog back into the Boundary Area (10C). Immediately praise and offer him a treat as he enters the Boundary Area, even if you have helped with the leash. Wiggle a Boundary Flag to help your dog understand that the discomfort of the Stimulation happens around the flags.
4. Repeat this process at the same Boundary Flag until your dog resists going into the Stimulation Zone.
5. Aim to master 3-4 Boundary Flags per session. Make this FUN! Praise your dog if he quickly retreats or resists going into the Stimulation Zone.

NOTE: Never allow your dog to eat the treat in the Stimulation Zone.

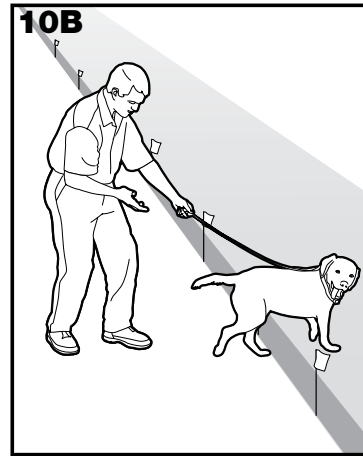
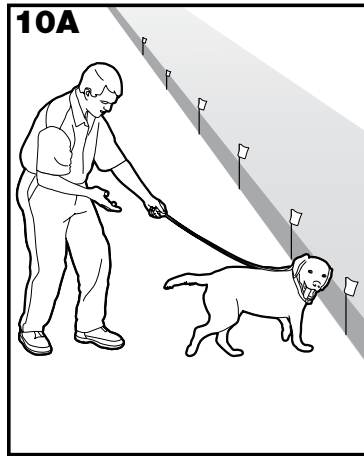

PHASE :: 02

## DAYS 2 THRU 4 - CONTINUE BOUNDARY FLAG AWARENESS

Perform three sessions per day, each lasting 10-15 minutes.

**GOAL:**

To train your dog to stay in the Boundary Area and respect the boundary while you are outside of it.

**SETUP:**

- Begin training with Stimulation Level 2 and only increase if your dog does not respond to the Stimulation.
- Put a separate non-metallic collar on your dog's neck ABOVE the Collar Receiver and attach a leash.

**CAUTION** Be sure the extra collar does not put pressure on the Contact Points.

- Have tiny pieces of treats available.
- Have your dog's favorite play toy available.

**STEPS:**

1. Repeat steps 1-4 in Phase One.
2. Drop the leash, leaving your dog in the Boundary Area.
3. Walk outside the boundary and wiggle the Boundary Flags facing your dog.
4. Continue around the entire boundary doing this, tossing treats to your dog in the Boundary Area and praising him.

PHASE :: 03

## DAYS 5 THRU 8 - DISTRACTION PHASE

Perform three training sessions per day, each lasting 10 to 15 minutes.

**GOAL:**

To train your dog to stay within the Boundary Area with distractions outside of the Boundary Area.

**SETUP:**

- Begin training with Stimulation Level 2 and only increase if your dog does not respond to the Stimulation.
- Put a separate non-metallic collar on your dog's neck ABOVE the Collar Receiver and attach a leash.

**CAUTION** Be sure the extra collar does not put pressure on the Contact Points.

- Have tiny pieces of treats available.
- Have your dog's favorite play toy available.
- Create distractions to tempt your dog to enter the Warning and Stimulation Zones, such as:
  - Have a family member cross from inside the Boundary Area to outside of it.
  - Throw a ball outside of the Boundary Area.
  - Have a neighbor walk their dog outside of the Boundary Area.

PHASE :: 04

## DAYS 9 THRU 14 - UNLEASHED SUPERVISION

Training sessions should start at 10-15 minutes, gradually increasing to over an hour.

Your dog is ready for this step only when he clearly avoids the entire Boundary Flag line, regardless of any distractions or temptations. During this step, do not leave your dog unattended.

**GOAL:**

To give your dog free run of the Boundary Area off the leash.

**SETUP:**

Adjust the Collar Receiver to the permanent setting appropriate for your dog depending on his size and temperament.

**STEPS:**

1. Enter the Boundary Area with your dog wearing the Collar Receiver.
2. Walk around the yard and play with your dog, staying within the Boundary Area at all times.
3. Preoccupy yourself with another task in the yard while watching your dog.
4. Should your dog escape, take the Collar Receiver off or turn the system off at the Fence Transmitter and lead him back into the Boundary Area.

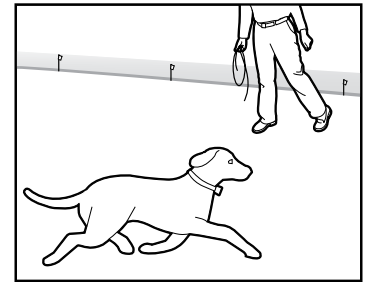

PHASE :: 05

## DAYS 15 THRU 30 - MONITORING YOUR DOG

Your dog is ready to run! Check in on your dog at regular intervals.

NOTE: After you are satisfied your dog's training is complete, remove every other Boundary Flag every 4 days until all flags are removed. Save Boundary Flags for future use.

## TAKING YOUR DOG OUT OF THE BOUNDARY AREA

**IMPORTANT: REMOVE THE COLLAR RECEIVER.**

Once your dog learns the Boundary Area, he will be reluctant to cross it for walks or car rides.  
**Option 1:** Replace the Collar Receiver with a regular collar. Put your dog in a car that is within the Boundary Area and drive him out of the Boundary Area.

**Option 2:** Replace the Collar Receiver with a regular collar and leash. Walk your dog out of the Boundary Area while giving a command such as "OK" at a specific place of the Boundary Area (the end of your driveway, sidewalk, etc.). Always leave the Boundary Area with a leash at this place and your dog will associate leaving the Boundary Area only on a leash, only at this place, and only with a person. You may initially need to convince your dog to leave the Boundary Area with a food treat and lots of praise.

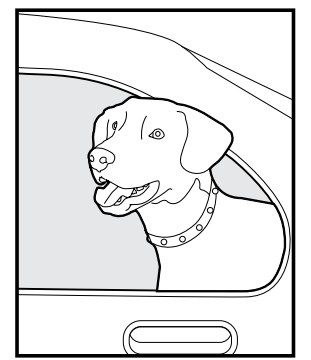

NOTE: You may also carry your dog out of the Boundary Area.

**Congratulations! You have now successfully completed the training program.**

# ACCESSORIES

To purchase additional accessories for your SportDOG Brand® In-Ground Fence System, contact the Customer Care Center at 1-800-732-0144 or visit our website at [www.sportdog.com](http://www.sportdog.com) to locate a retailer near you.

Component	Part Number
Battery (9V)	PAC11-12067
Power Adapter for Fence Transmitter (USA & Canada)	SDT00-12161
Power Adapter for Fence Transmitter (Australia)	SAC00-12765
Surge Protection Kit (USA & Canada)	LP-4100*
Replacement Black Collar	SAC00-12720
Additional Collar Receiver	SDF-R
Wire & Flag Accessory Kit	SDF-WF
Wire Nuts and Waterproof Wire Nut Covers (2 each)	RFA-366
Fence Transmitter	SDT00-12721
Wire Break Locator	RFA-50
Accessory Pack for Collar Receiver**	RFA-281

**\*NOTICE:** Be sure your in-ground loop system is grounded to provide some protection against voltage surges. Article 810 of the National Electrical Code, ANSI/NFPA 70, provides information with regard to proper grounding of the lead-in wire to an antenna discharge unit and location of the antenna-discharge unit. A LP-4100 (Surge Protection Kit) can be used for this purpose, as well as, to help protect against power line surges. The LP-4100 is available by contacting Customer Care.

**\*\*INCLUDES:** 2 each medium Contact Points, long Contact Points, collar retainer, collar washer, switch cap and (4) screws.

# FREQUENTLY ASKED QUESTIONS

Will the SDF-100A work in my yard?	Yes. This system works in yards up to 100 acres with the purchase of additional wire and flag kits (SDF-WF). This system includes 1,000 feet of wire and 100 boundary flags. Please refer to the wire chart on page 10 for more information.
Is my dog too big (or little)?	The SportDOG Brand® In-Ground Fence System has been proven safe and effective for dogs over 10 pounds. The adjustable collar and Stimulation levels allow you to create a perfect solution for your dog.
Can my children get hurt?	NO. The mild correction is produced by the Contact Points on the Collar Receiver, not the Boundary Wire. With proper use, the system is safe for all.
I have a small dog and a large dog; will this work for me?	YES. Since the SportDOG Brand In-Ground Fence System provides just the right amount of adjustable stimulation within each dog's collar, it is safe and effective for all the dogs in your family over 10 pounds. The kit includes one collar; additional collars are sold separately (SDF-R Add-A-Dog®).
Is this complicated?	No. This operating and training guide will walk you through every step.
Can I use the system with an existing fence?	YES. The system can be used with an existing fence if you have a problem with a dog digging or jumping over a traditional fence.
How often will my dog receive a correction?	When trained properly, most dogs will only receive a few corrections during normal usage.
How old does my dog have to be before starting to train on the In-Ground system?	Because all dogs are different, training on the SportDOG Brand In-Ground Fence System can be started once your dog can learn basic obedience commands like "sit" and "stay."
Can I twist one wire to make a gate or safe area that my dog can cross?	No. The wires need to meet in order to cancel out the signal (See 3A page 9).
Does the Range Adjuster knob tell me how wide my Boundary Width will be?	Every yard is different. You will have to use the Collar Receiver to find the Boundary Width. Refer to Step 6 on pages 13-14.
Can I use the SDF-100A with more than one dog?	Yes. Any number of dogs can be added to the system with the purchase of SDF-R Add-A-Dog Collar Receivers.
Are there other collars besides the SDF-R that are compatible with my SDF-100A system?	Yes, the PetSafe® In-Ground Fence Extra Receiver Collars will work with this system. They include the PUL-250 UltraLight, the PUL-275 Deluxe UltraLight, the PRF-275-11 Stubborn Dog and the PIG00-10778 Little Dog.
Why is my SDF-100A Transmitter beeping?	You have a break in your Boundary Wire. Refer to "TO LOCATE A BREAK IN THE BOUNDARY WIRE" section on page 24 for more information.
Why is it suggested to preform a Short Loop Test?	A Short Loop Test is a simple test to determine if each component (Fence Transmitter, Collar Receiver and Boundary Wire) is functioning properly. Follow the steps outlined on page 23.

# TROUBLESHOOTING

Collar Receiver is not beeping or correcting.	<ul style="list-style-type: none"> <li>• Check battery to make sure it is installed properly (page 12).</li> <li>• Check that both lights are lit on the Fence Transmitter. If not, perform the “Short Loop Test” (page 23).</li> </ul>
The Collar Receiver is beeping, but the dog is not responding to the Stimulation.	<ul style="list-style-type: none"> <li>• Make sure the Stimulation Level is set at 2 or above.</li> <li>• Test the Collar Receiver with the Test Light (6B, page 13).</li> <li>• If the Test Light flashes, check the fit of the Collar Receiver (Step 9, page 16).</li> <li>• Trim your dog’s hair where the Contact Points touch the neck and/or switch to the longer Contact Points.</li> <li>• Increase the Stimulation Level.</li> <li>• Repeat training steps to reinforce training.</li> </ul>
The Collar Receiver has to be held on top of the Boundary Wire to activate.	<ul style="list-style-type: none"> <li>• Replace battery.</li> <li>• Adjust Range Adjuster knob clockwise to increase the distance from the Boundary Wire that the Collar Receiver activates.</li> <li>• Adjust the Range Switch to the other setting.</li> <li>• If using a Double Loop, make sure Boundary Wires are separated 3 to 5 feet.</li> <li>• If the Collar Receiver still has to be held on top of the Boundary Wire, perform the “Short Loop Test” (page 23).</li> </ul>
The Collar Receiver activates inside the house.	<ul style="list-style-type: none"> <li>• Turn the Range Adjuster knob counterclockwise to decrease the distance from the Boundary Wire that the Collar Receiver activates.</li> <li>• Make sure the Boundary Wire is not running too close to the house. The signal can transmit through the walls of your house.</li> <li>• Make sure Boundary Wires are twisted from Boundary to the Fence Transmitter.</li> </ul>
I have an inconsistent signal.	<ul style="list-style-type: none"> <li>• Make sure the Fence Transmitter is at least 3 feet from large metal objects or appliances.</li> <li>• Make sure all Boundary Wire turns are gradual.</li> <li>• Make sure the Boundary Wire is not running parallel to and within 5 feet of electrical wires, neighboring containment systems, telephone wires, television or antenna cables, or satellite dishes.</li> <li>• If a neighboring containment system may be causing an inconsistent signal, contact the Customer Care Center.</li> </ul>
The Power and Loop Indicator Lights are off.	<ul style="list-style-type: none"> <li>• Check that the Power Adapter is plugged into the Fence Transmitter.</li> <li>• Try plugging into another electrical outlet.</li> <li>• Replace the fuses, refer to (Step 4C, page 11).</li> <li>• If the lights still do not come on, the Fence Transmitter and/or Power Adapter needs to be replaced. Contact the Customer Care Center.</li> </ul>
The Power Light is on, the Loop Indicator Light is off, and the Fence Transmitter loop alarm is sounding.	<ul style="list-style-type: none"> <li>• Make sure both ends of the Boundary Wire are plugged into Boundary Wire Terminals and that ½ inch of the insulation is stripped so that the copper wire is exposed.</li> <li>• Perform the “Short Loop Test” to determine if the Fence Transmitter needs to be replaced or if the Boundary Wire is broken (page 23).</li> <li>• If the Fence Transmitter is functioning properly, you have a break in your Boundary Wire. See the “Locating a Break in the Wire” section in this guide (page 24).</li> </ul>
The fuses blow when they are replaced.	<ul style="list-style-type: none"> <li>• The Fence Transmitter and/or Power Adapter needs to be replaced. Contact the Customer Care Center.</li> </ul>

## ADDITIONAL INFORMATION

- The system should only be used with healthy dogs. Contact your veterinarian if you have concerns about the medical condition of your dog (medication, pregnant, heart conditions, etc.).
- The SportDOG Brand® In-Ground Fence System is for residential use only.
- The Stimulation will get your dog’s attention, but will not cause harm. It is designed to startle, not to punish.
- Test the Collar Receiver every 3 to 6 months. Battery life depends upon how often the Collar Receiver is used.
- Remove the Receiver Collar from your dog when indoors for the comfort of your dog.

## SHORT LOOP TEST

The Short Loop Test is a simple test to determine if each component (Fence Transmitter, Collar Receiver and Boundary Wire) is functioning properly.

1. Disconnect the Boundary Wire and Ground Wire.
2. Cut approximately 10 feet of unused Boundary Wire and connect it to the Boundary Wire Terminals.
3. Attach the Test Light to the Collar Receiver.
4. Spread the Boundary Wire out into a circle. Set the Range Switch to LOW.
5. Set the Range Adjuster knob to 10 and the Stimulation Level to level 2 or above.
6. If the Loop Indicator Light is not lit, then your Fence Transmitter is not functioning properly. Contact the Customer Care Center at 1-800-732-0144.
7. If the Loop Indicator Light is lit, disconnect one end of the Boundary Wire from the Boundary Wire Terminal.
8. If the loop alarm does not sound, the Fence Transmitter needs to be replaced. Contact the Customer Care Center.
9. If the loop alarm does sound, plug the Boundary Wire back into the Boundary Wire Terminal.
10. Hold the Collar Receiver next to the 10-foot length of Boundary Wire. The Collar Receiver should beep about one foot away from the Boundary Wire. The Test Light should then flash as you hold the Collar Receiver closer to the Boundary Wire.
11. If the Collar Receiver does not beep and the Test Light does not flash, replace the battery in the Collar Receiver. If it still does not beep and the Test Light does not flash, contact the Customer Care Center.
12. If the Collar Receiver beeps, there may be a complete or partial break in the Boundary Wire. See the “To Locate a Break in the Boundary Wire” section on the following page.

# TO LOCATE A BREAK IN THE BOUNDARY WIRE

Please follow these steps in determining where you have a break in your Boundary Wire:

1. Locate your original splice(s) and verify they have a good, solid connection.
2. Check your yard to determine any possible damage to the Boundary Wire (recent digging, aerating, rodent burrowing, or any other noticeable disturbance in your yard next to the Boundary Wire).

If you still cannot find the break in the Boundary Wire, there are two options for locating it:

**Option 1:** Contact the Customer Care Center at 1-800-732-0144 to purchase a Wire Break Locator (RFA-450) that will locate the break in the Boundary Wire.

**Option 2:** Follow the procedure below:

**CAUTION** To prevent an unintended correction, always remove your dog's Collar Receiver before performing any Transmitter testing.

1. Unplug the Fence Transmitter.
2. Connect both ends of your twisted Boundary Wire to one Boundary Wire Terminal.
3. Measure and cut a Test Wire which is half the length of your total Boundary Wire footage.
4. Connect one end of the Test Wire to the other Boundary Wire Terminal.
5. Locate the halfway point of your boundary and cut the Boundary Wire.
6. Splice the other end of the Test Wire to either side of your Boundary Wire where you cut it in half.
7. Plug in the Fence Transmitter and check the Loop Indicator Light. If the Loop Indicator Light is on you can assume the break is in the other half of the Boundary Wire.
8. If the Loop Indicator Light did not come on and you hear a continuous beep, you may assume there is a break in this portion of the Boundary Wire. However, there is a small chance of having more than one break in your system. Be sure to check both halves of your entire loop.
9. Replace the damaged Boundary Wire with new Boundary Wire.
10. Reconnect the Boundary Wire to the Fence Transmitter.
11. Check the Loop Indicator Light. If the Loop Indicator Light is on, test the system with the Collar Receiver.

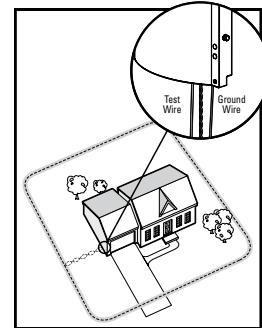

# TERMS OF USE AND LIMITATION OF LIABILITY

## 1. TERMS OF USE

This Product is offered to you conditioned upon your acceptance without modification of the terms, conditions and notices contained herein. Usage of this Product implies acceptance of all such terms, conditions, and notices.

## 2. PROPER USE

This Product is designed for use with dogs where training is desired. The specific temperament of your dog may not work with this Product. We recommend that you not use this Product if your dog is less than 10 pounds or if your dog is aggressive. If you are unsure whether this is appropriate for your dog, please consult your veterinarian, certified trainer or contact our Customer Care Center at 1-800-732-0144.

Proper use includes reviewing the entire Operating and Training Guide provided with your Product and any specific Caution statements.

## 3. NO UNLAWFUL OR PROHIBITED USE

This Product is designed for use with dogs only. This dog training device is not intended to harm, injure, or provoke. Using this Product in a way that is not intended could result in violation of Federal, State or local laws.

## 4. LIMITATION OF LIABILITY

In no event shall Radio Systems® Corporation be liable for any direct, indirect, punitive, incidental, special or consequential damages, or any damages whatsoever arising out of or connected with the use or misuse of this Product. Buyer assumes all risks and liability from the use of this Product.

## 5. MODIFICATION OF TERMS AND CONDITIONS

Radio Systems Corporation reserves the right to change the terms, conditions and notices under which this Product is offered.

# COMPLIANCE

## FCC/CANADA

This Class B digital apparatus complies with Canadian ICES-003. This equipment has been tested and found to comply with the limits for a Class B digital device, pursuant to Part 15 of the FCC Rules. These limits are designed to provide reasonable protection against harmful interference when the equipment is operated in a residential environment. This equipment generates, uses, and can radiate radio frequency energy and, if not installed and used in accordance with the instruction guide, may cause harmful interference to radio communications. However, there is no guarantee that interference will not occur in a practical installation. If this equipment causes harmful interference to radio or television reception, which can be determined by turning the equipment off and on, the user is encouraged to try to correct the interference by one or more of the following measures:

- Relocate the interfered receiving antenna.
- Increase the separation between the equipment and receiver.
- Connect the equipment into an outlet on a circuit different from that to which the receiver is connected.
- Contact the Customer Care Center.

This device complies with Industry Canada Rules. This device complies with part 15 of the FCC Rules. Operation is subject to the following two conditions: (1) This device may not cause harmful interference, and (2) this device must accept any interference received, including interference that may cause undesired operation.

Unauthorized changes or modifications to the equipment, not approved by Radio Systems® Corporation, could result in not meeting compliance with FCC regulations and could void the user's authority to operate the equipment.

## AUSTRALIA

This device complies with the applicable EMC requirements specified by the ACMA (Australian Communications and Media Authority).

# CUSTOMER CARE INTERNATIONAL

Canada - Tel: 800-732-2677

Monday - Friday 8 AM - 8 PM / Saturday 9 AM - 5 PM

Australia - Tel: 1800 786 608

Monday - Friday 7:30 AM - 5 PM

New Zealand - Tel: 0800 543 054

Monday - Friday 10:30 AM - 7 PM

This product has the benefit of a 2 year warranty. Details of the warranty applicable to this product and its terms can be found at [www.sportdog.com](http://www.sportdog.com).



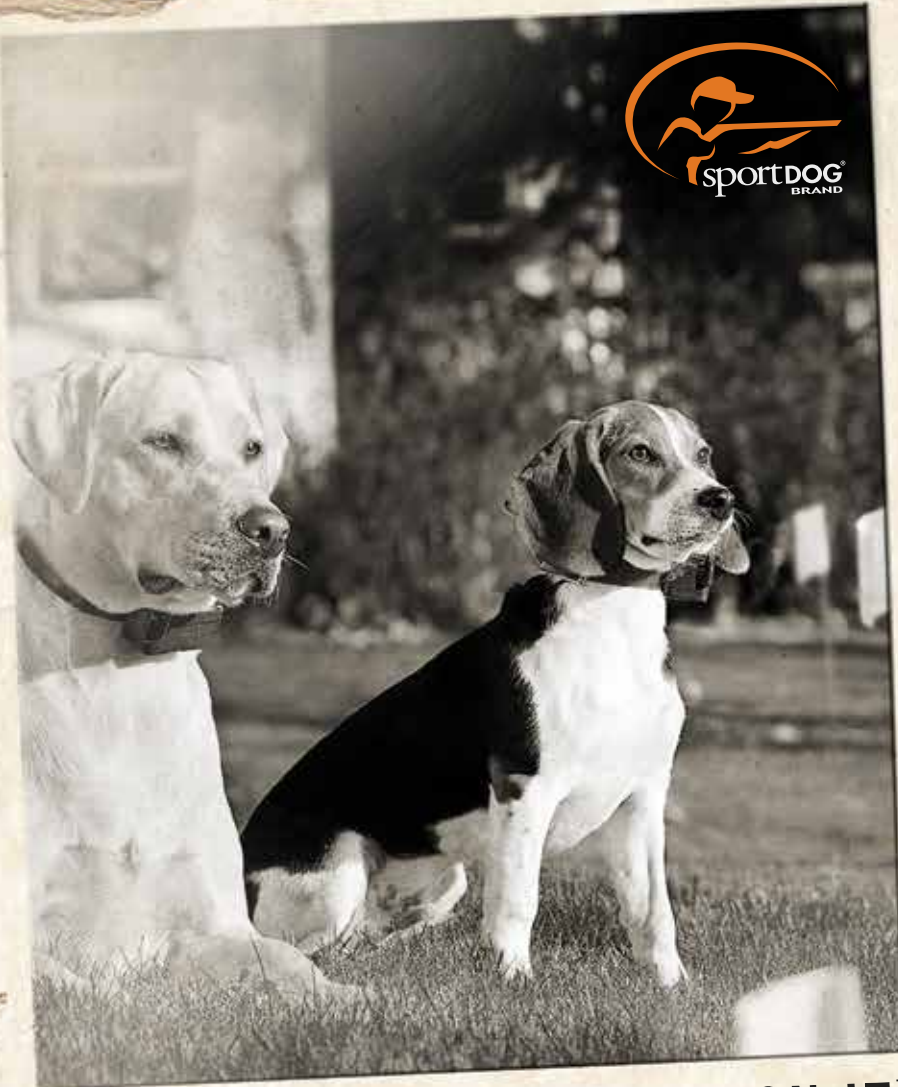

**SPORTDOG.COM**

**GEAR THE WAY YOU'D DESIGN IT™**  
*Wire & Flag Kit and Add-A-Dog® Collar Receiver*



**SDF::WF WIRE & FLAG KIT**



**SDF::R ADD-A-DOG®**