

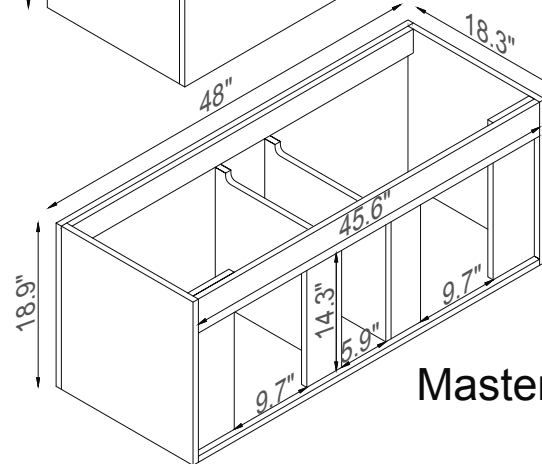

Streamline

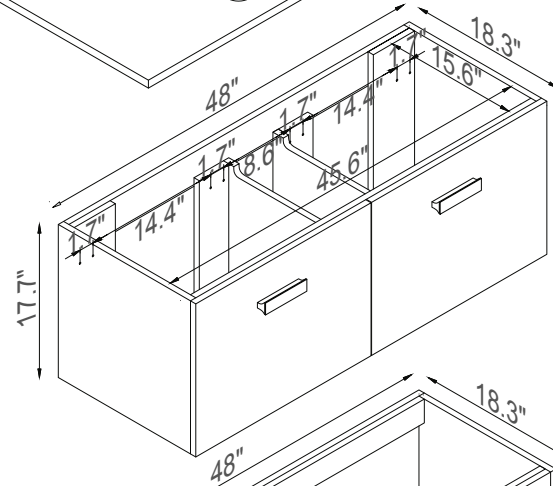
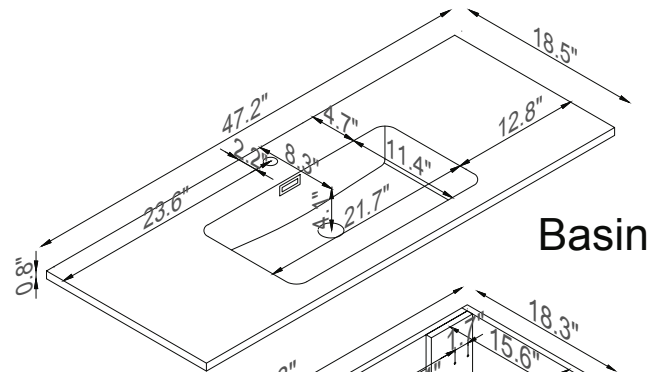

K1801-161-48-51