



SURFboard™ SB6183 DOCSIS® 3.0 Cable Modem

User Guide

ARRIS Copyrights and Trademarks

©2015 ARRIS Enterprises, Inc. All rights reserved.

No part of this publication may be reproduced in any form or by any means or used to make any derivative work (such as translation, transformation, or adaptation) without written permission from ARRIS Enterprises, Inc. ("ARRIS"). ARRIS reserves the right to revise this publication and to make changes in content from time to time without obligation on the part of ARRIS to provide notification of such revision or change.

ARRIS, SURFboard, and the ARRIS logo are all trademarks or registered trademarks of ARRIS Enterprises, Inc. Other trademarks and trade names may be used in this document to refer to either the entities claiming the marks and the names of their products. ARRIS disclaims proprietary interest in the marks and names of others.

ARRIS provides this guide without warranty of any kind, implied or expressed, including, but not limited to, the implied warranties of merchantability and fitness for a particular purpose. ARRIS may make improvements or changes in the product(s) described in this manual at any time.

The capabilities, system requirements and/or compatibility with third-party products described herein are subject to change without notice.

Table of Contents

1. Safety and Regulatory Information	5
Important Safety Instructions.....	5
FCC Statements.....	7
Caring for the Environment by Recycling	9
2. Getting Started	10
Introduction	10
In the Box.....	10
Additional Item(s) You May Need.....	11
System Requirements.....	11
Contact Information	12
3. Product Overview	13
Front Panel	13
Rear Panel.....	14
Cable Modem Label.....	14
4. Installing the Cable Modem	15
Connect the SB6183 to Your Computer	15
Establish an Internet Connection	16
5. Using the Cable Modem Web Manager	17
Start the SB6183 Web Manager	17
SB6183 Web Manager Screen Options.....	18
Get Help.....	19
Exit the SB6183 Web Manager	19
6. Monitoring Your Cable Modem and Connected Network	20
View the SB6183 Network Connection Status	20
View the SB6183 Product Information.....	21
View the SB6183 Event Log	22
View the SB6183 Cable Modem Configuration	22
Reset the SB6183 Configuration Settings.....	23
Reboot the SB6183	24
Exit the SB6183 Web Manager	25
7. Troubleshooting Tips	26
Solutions	26

Front Panel LED Icons and Error Conditions.....	27
8. Warranty Information	28

Safety and Regulatory Information

Important Safety Instructions

Read This Before You Begin — When using your equipment, basic safety precautions should always be followed to reduce the risk of fire, electric shock, and injury to persons, including the following:

- Read all of the instructions listed here and/or in the user manual before you operate this device. Give particular attention to all safety precautions. Retain the instructions for future reference.
- This device must be installed and used in strict accordance with manufacturer's instructions, as described in the user documentation that is included with the device.
- Comply with all warning and caution statements in the instructions. Observe all warning and caution symbols that are affixed to this device.
- To prevent fire or shock hazard, do not expose this device to rain or moisture. The device must not be exposed to dripping or splashing. Do not place objects filled with liquids, such as vases, on the device.
- This device was qualified under test conditions that included the use of the supplied cables between system components. To ensure regulatory and safety compliance, use only the provided power and interface cables and install them properly.
- Different types of cord sets may be used for connections to the main POWER supply circuit. Use only a main line cord that complies with all applicable device safety requirements of the country of use.
- Installation of this device must be in accordance with national wiring codes and conform to local regulations.
- Operate this device only from the type of power source indicated on the device's marking label. If you are not sure of the type of power supplied to your home, consult your dealer or local power company.
- Do not overload outlets or extension cords, as this can result in a risk of fire or electric shock. Overloaded electrical outlets, extension cords, frayed power cords, damaged or cracked wire insulation, and broken plugs are dangerous. They may result in a shock or fire hazard.
- Route power supply cords so that they are not likely to be walked on or pinched by items placed upon or against them. Pay particular attention to cords where they are attached to plugs and convenience receptacles, and examine the point where they exit from the device.

- Place this device in a location that is close enough to an electrical outlet to accommodate the length of the power cord.
- Place the device to allow for easy access when disconnecting the power cord of the device from the electrical wall outlet.
- Do not connect the plug into an extension cord, receptacle, or other outlet unless the plug can be fully inserted with no part of the blades exposed.
- Place this device on a stable surface.
- Avoid damaging the device with static by touching the coaxial cable when it is attached to the earth-grounded coaxial cable-TV wall outlet.
- Always first touch the coaxial cable connector on the device when disconnecting or reconnecting the Ethernet cable from the device or user's PC.
- It is recommended that the customer install an electrical surge protector in the electrical outlet to which this device is connected. This is to avoid damaging the device by local lightning strikes and other electrical surges.
- Postpone installation until there is no risk of thunderstorm or lightning activity in the area.
- Do not use this product near water: for example, near a bathtub, washbowl, kitchen sink or laundry tub, in a wet basement, or near a swimming pool.
- Do not cover the device or block the airflow to the device with any other objects. Keep the device away from excessive heat and humidity and keep the device free from vibration and dust.
- Wipe the device with a clean, dry cloth. Never use cleaning fluid or similar chemicals. Do not spray cleaners directly on the device or use forced air to remove dust.
- For added protection, unplug the device from the wall outlet and disconnect the cables to avoid damage to this device during lightning activity or power surges.
- Upon completion of any service or repairs to this device, ask the service technician to perform safety checks to determine that the device is in safe operating condition.
- Do not open the device. Do not perform any servicing other than that contained in the installation and troubleshooting instructions. Refer all servicing to qualified service personnel.
- This device should not be used in an environment that exceeds 104° F (40° C).

SAVE THE ABOVE INSTRUCTIONS

Note to CATV System Installer — This reminder is provided to call the CATV system installer's attention to Article 820.93 and 820.100 of the National Electric Code, which provides guidelines for proper grounding and, in particular, specifies that the Coaxial cable shield shall be connected to the grounding system of the building, as close to the point of cable entry as practical.

FCC Statements

FCC Interference Statement

This equipment has been tested and found to comply with the limits for a Class B digital device, pursuant to part 15 of the FCC Rules. These limits are designed to provide reasonable protection against harmful interference in a residential environment. This equipment generates, uses, and can radiate radio frequency energy and, if not installed and used in accordance with the instructions, may cause harmful interference to radio communications. However, there is no guarantee that interference will not occur in a particular installation. If this equipment does cause harmful interference to radio or television reception, which can be determined by turning the device off and on, the user is encouraged to try to correct the interference by one or more of the following measures:

- Reorient or relocate the receiving antenna.
- Increase the separation between the device and receiver.
- Connect the equipment into an outlet on a circuit different from that to which the receiver is connected.
- Consult the dealer or an experienced radio/TV technician for help.

This device complies with Part 15 of the FCC Rules. Operation is subject to the following two conditions: (1) This device may not cause harmful interference, and (2) This device must accept any interference received, including interference that may cause undesired operation.

FCC Caution: Any changes or modifications not expressly approved by Motorola for compliance could void the user's authority to operate the equipment.

FCC Radiation Exposure Statement

This equipment complies with FCC radiation exposure limits set forth for an uncontrolled environment. To comply with the FCC RF exposure compliance requirements, the separation distance between the antenna and any person's body (including hands, wrists, feet and ankles) must be at least 8 inches (20.3 centimeters).

This transmitter must not be co-located or operating in conjunction with any other antenna or transmitter except those already approved in this filing.

The availability of some specific channels and/or operational frequency bands are country dependent and are firmware programmed at the factory to match the intended destinations. The firmware setting is not accessible by the end user.

Industry Canada (IC) Statement

This device complies with RSS-210 of the Industry Canada Rules. Operation is subject to the following two conditions:

- This device may not cause interference, and
- This device must accept any interference, including interference that may cause undesired operation of the device.

CAN ICES-3 (B)/NMB-3 (B)

In Canada, RLAN devices are restricted from using the 5600-5650 MHz frequency band.

Caution: To reduce the potential for harmful interference to co-channel mobile satellite systems, use of the 5150-5250 MHz frequency band is restricted to indoor use only.

High power radars are allocated as primary users (meaning they have priority) of 5250-5350 MHz and 5650-5850 MHz frequency bands. These radars could cause interference and/or damage to License Exempt–Local Area Network (LE-LAN) devices.

IC Radiation Exposure Statement

Important Note: *This equipment complies with IC radiation exposure limits set forth for an uncontrolled environment. This equipment should be installed and operated with a minimum distance of 20 centimeters between the radiator and your body.*

Avis D'Industrie Canada (IC)

Cet appareil est conforme à la réglementation RSS-210 d'Industrie Canada. Son utilisation est assujettie aux deux conditions suivantes:

- Cet appareil ne doit pas causer d'interférences et
- Cet appareil doit accepter toute interférence reçue, y compris les interférences causant un fonctionnement non désiré.

CAN ICES-3 (B)/NMB-3 (B)

Au Canada, les appareils de réseau local sans fil ne sont pas autorisés à utiliser les bandes de fréquence 5600-5650 MHz.

Avertissement: afin de réduire les risques de brouillage préjudiciable aux systèmes de satellites mobiles utilisant les mêmes canaux, les dispositifs fonctionnant dans la bande 5150-5250 MHz sont réservés uniquement pour une utilisation à l'intérieur

Les radars à haute puissance sont définis en tant qu'utilisateurs principaux (c.-à-d. prioritaires) des bandes de fréquences 5250-5350 MHz et 5650-5850 MHz. Ces radars peuvent causer de l'interférence ou des dommages susceptibles de nuire aux appareils exempts de licence–réseau local (LAN-EL).

Déclaration de IC sur L'Exposition aux Rayonnements

Note Importante: *cet équipement est conforme aux limites d'exposition aux rayonnements établies par IC pour un environnement non contrôlé. Cet équipement doit être installé et utilisé de manière à maintenir une distance d'au moins 20 cm entre la source de rayonnement et votre corps.*

Caring for the Environment by Recycling



When you see this symbol on an ARRIS product, do not dispose of the product with residential or commercial waste.

Recycling your ARRIS Equipment

Please do not dispose of this product with your residential or commercial waste. Some countries or regions, such as the European Union, have set up systems to collect and recycle electrical and electronic waste items. Contact your local authorities for information about practices established for your region. If collection systems are not available, call ARRIS Customer Service at **1-877-466-8646** for assistance.

Getting Started

Introduction





The ARRIS SURFboard® SB6183 DOCSIS 3.0® Cable Modem provides a secure ultra high-speed broadband connection to the Internet for your computer and other network devices on your home or small business network.



This guide provides a product overview and instructions for installing and setting up your SB6183 to get it connected to your home network.

In the Box

Before installing the SB6183, check that the following items are also included in the box. If any items are missing, please call ARRIS Technical Support at **1-877-466-8646** for assistance.

Table 1. SB6183 Package Contents

Item		Description
SB6183 Cable Modem		High-speed DOCSIS 3.0 cable modem
Power Supply		Power cord for an electrical wall outlet connection
Ethernet Cable		Standard Category 5 (CAT5) or higher cable for connecting to the network
Software License & Regulatory Card		Software license, warranty, Safety instructions, and regulatory information for the cable modem

Item	Description
Support Information Card	 <p>Contact information for obtaining technical support assistance with your SURFboard device</p>
SB6183 Quick Start Guide	 <p>Basic information for installing the cable modem and connecting to the Internet on your home network.</p>

Additional Item(s) You May Need

The following item is not included in the box and must be purchased separately, if required:

- Coaxial (coax) cable, if one is not already connected to a cable wall outlet

System Requirements

- High-speed Internet access account
- Web browser access – Internet Explorer, Google Chrome, Firefox, or Safari
- Compatible operating systems:
 - Windows®10
 - Windows 8
 - Windows 7 Service Pack 1 (SP1)
 - Windows Vista™ SP2 or later
 - Windows XP SP3



Note: Microsoft no longer supports Windows XP. The SB6183 should still function without any problems.

- Macintosh® 10.4 or higher
- UNIX®
- Linux®

Contact Information

For technical support and additional ARRIS product information:

- Visit the ARRIS Support website: www.arris.com/consumer
(<http://www.arris.com/consumer>)
- Call ARRIS Technical Support: **1-877-466-8646**

Product Overview

Front Panel

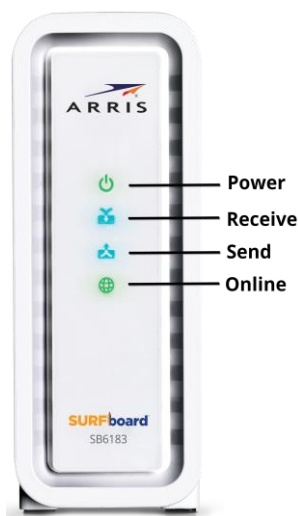





Figure 1: SB6183 Front View

Table 2. SB6183 Front Panel LED Icons

LED Icon	Blinking	On (Solid)
 POWER	Not applicable – icon does not blink.	Green: Power is properly connected.
 RECEIVE	Scanning for a downstream (receive) channel connection.	Green: Non-bonded downstream channel is connected. Blue*: High-speed Internet connection with bonded downstream channels.
 SEND	Scanning for an upstream (send) channel connection.	Green: Non-bonded upstream channel is connected. Blue*: High-speed Internet connection with bonded upstream channels.
 ONLINE	Scanning for an Internet connection.	Green: Startup process completed.

***Blue:** Indicates DOCSIS 3.0 operation (high-speed Internet access) which may not be available in all locations. Check with your service provider for availability in your area.

Rear Panel

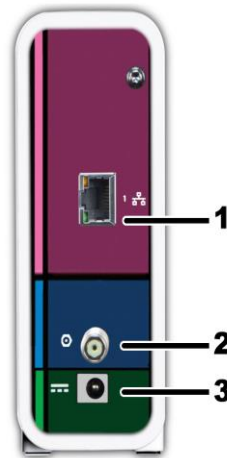





Figure 2: SB6183 Rear View

Table 3. SB6183 Rear Panel Ports & Connectors

Description	
 ETHERNET	10/100/1000Base-T Ethernet port <ul style="list-style-type: none"> ■ Green: LED is ON – Indicates a 1 Gb data connection is made ■ Green: LED is Blinking - Indicates data traffic is in progress ■ Amber: LED is ON – Indicates a 10/100 Mb data connection is made ■ Amber: LED is Blinking – Indicates data traffic is in progress
 CABLE	Coaxial cable connector
 POWER	+12VDC Power connector <div style="display: flex; align-items: center; margin-top: 5px;">  <p>WARNING! To avoid any damage to your SB6183, only use the power supply provided in the box.</p> </div>

Cable Modem Label

The cable modem label is located on the bottom of the SB6183. It contains the cable modem ID that you may need when contacting your service provider or ARRIS Technical Support.

To receive Internet service, contact your service provider for assistance. You may need to provide the following information listed on the cable modem label:

- Cable modem Model name (**SB6183**)
- Cable modem MAC address (**HFC MAC ID**)
- Cable modem Serial number (**S/N**)

Installing the Cable Modem



Caution: This product is for indoor use only. Do not route the Ethernet cable(s) outside of the building. Exposure of the cables to lightning could create a safety hazard and damage the product.

Connect the SB6183 to Your Computer

Before installing the SB6183:

- Check with your service provider to ensure broadband cable service is available in your area.
- Choose a location in your home where your computer and cable modem are preferably near existing cable and electrical wall outlets.

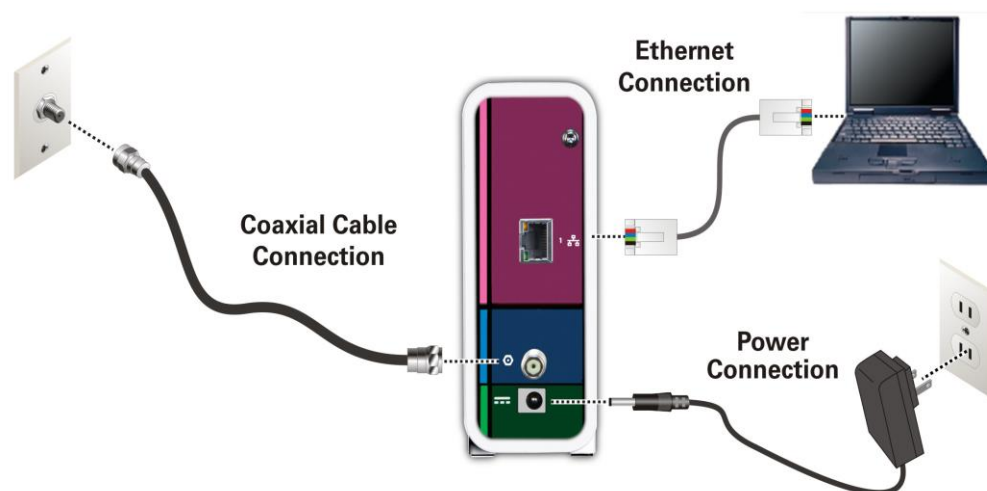

Figure 3: SB6183 Connection Diagram

1. Check that a coaxial cable is already connected to a cable wall outlet or RF splitter (optional).
2. Connect the other end of the coaxial cable to the **Cable** connector on the rear of the SB6183.
Use your hand to tighten the connectors to avoid damaging them.
3. Connect the Ethernet cable to the **Ethernet** port on the rear of the SB6183.
4. Connect the other end of the Ethernet cable to the **Ethernet** port on your computer.
5. Connect the power cord to the **Power** port on the rear of the SB6183.

6. Plug the other end of the power cord into an electrical wall outlet that is not controlled by a wall switch.



Note: This automatically powers ON the SB6183.

Establish an Internet Connection

Although your computer may already be configured to automatically access the Internet, you should still perform the following cable modem connectivity test to check that your devices were connected properly:

1. Power ON the computer connected to the SB6183, if it is turned off, and then log in.
2. Contact your service provider to activate (provision) the SB6183. You may have to provide the HFC MAC ID listed on the cable modem label.



Note: Your service provider may allow for automatic activation which will automatically launch their special website when you open a web browser.

3. After the SB6183 is provisioned (or activated), open a web browser (such as Internet Explorer, Google Chrome, Firefox, or Safari) on the computer.
4. Type a valid URL (such as **www.surfboard.com**) in the address bar and then press **Enter**. The ARRIS website should open. If it fails to open, please contact your service provider for assistance.
5. Check that the **Power**, **Receive**, **Send**, and **Online** front panel LEDs on the SB6183 light up in sequential order. See [Front Panel](#) (page 13) for additional LED status information.
 - If all four LEDs did not light up Solid and you are not connected to the Internet, you may have to contact your service provider to reactivate your SB6183 or check for possible signal issues.
 - If you still cannot connect to the Internet, the SB6183 may be defective. Please call ARRIS Technical Support at **1-877-466-8646** for assistance.

Using the Cable Modem Web Manager

The SB6183 Web Manager is available to view and monitor the SB6183 operational status and also to reset or reboot the SB6183.

Start the SB6183 Web Manager

1. Open any Web browser on the computer connected to the SB6183.
2. Type the default LAN IP address, **192.168.100.1**, in the Address bar and then press **Enter**.

The SB6183 Status screen displays.

Startup Procedure								
Procedure				Status	Comment			
Acquire Downstream Channel					Locked			
Connectivity State				OK	Operational			
Boot State				OK	Operational			
Configuration File				OK				
Security				Enabled	BPI+			
DOCSIS Network Access Enabled				Allowed				
Downstream Bonded Channels								
Channel	Lock Status	Modulation	Channel ID	Frequency	Power	SNR	Corrected	Uncorrectables
1	Locked	QAM256	1	507000000 Hz	-5.6 dBmV	38.8 dB	0	0
Upstream Bonded Channels								
Channel	Lock Status	US Channel Type	Channel ID	Symbol Rate	Frequency	Power		
1	Locked	TDMA	1	1280 Ksym/sec	22864000 Hz	55.0 dBmV		
Current System Time: Wed Dec 09 16:55:18 2015								

Figure 4: SB6183 Opening Screen



Note: If you cannot access the HTML pages in the SB6183 Web Manager, please call or contact ARRIS Technical Support for assistance.

SB6183 Web Manager Screen Options

Menu Buttons and Links

You can use the web manager buttons or links to view the status and network configuration screens for the SB6183.

- The SB6183 menu buttons are displayed along the top of the SB6183 Web Manager screen. To display a specific web manager screen, click the menu button.

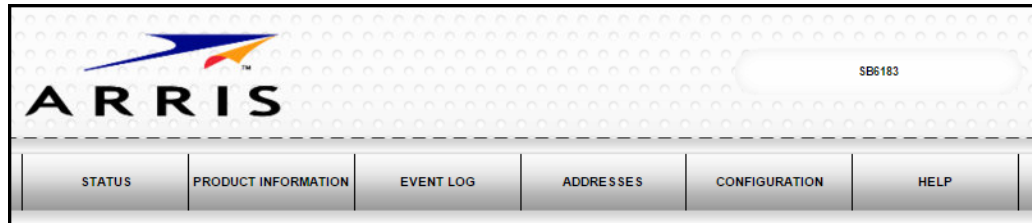

Figure 5: SB6183 Web Manager Menu Buttons

- The SB6183 menu links are displayed along the bottom of the SB6183 Web Manager screen. To display a specific web manager screen, click the menu link.



Figure 6: SB6183 Web Manager Menu Links

Table 4. SB6183 Web Manager Screen Options

Screen Option	Function
Status	Provides the current operational status of the cable modem.
Product Information	Provides the current hardware and software-related information for the cable modem.
Event Log	Displays a listing of the time and actual events as they occur and are detected by the cable modem. This information may be useful to help diagnose and correct any problems that may occur with the cable modem.
Addresses	Provides the serial number and MAC addresses for the cable modem and computers connected on your home network.

Screen Option	Function
Configuration	Provides the network connection frequency and channel ID information for the cable modem. Also, allows you to reset the cable modem configuration to the factory default configuration and restart the cable modem.
Help	Provides a brief description for each screen option and general troubleshooting tips.

Get Help

The Help Pages screen provides a brief description for each web manager screen.

- Click the **Help** menu button or link on the SB6183 Web Manager screen to open the SB6183 Help Pages screen.

Help Pages	
Status	The Status page is the first page in the display. This page shows diagnostic information about the startup procedure, the downstream bonded channels, and the upstream bonded channels.
Product Information	The Product Information page displays information about the hardware version, software version, MAC address, serial number, system "up" time, and network registration status.
Event Log	The Event Log page provides a list of all the events that have occurred on the cable modem. Each event shows the time that it occurred, the priority of the event, and an event description.
Addresses	The Addresses Page provides information about the network connection between the Cable Modem and your computer. Also, it provides details about the connection between the Cable Modem and the service provider's computer systems.
Configuration	The Configuration page lists information about the upstream and downstream connection to the service provider.
<small>For information regarding software licenses, acknowledgments and copyright notices for certain software packages and/or components that are used in this SB6183, please see the Open Source Software Information.</small>	

Figure 7: SB6183 Help Overview Screen

Exit the SB6183 Web Manager

To exit the SB6183 Web Manager:

- Click the **Close** button in the upper right corner of the web browser window.

Monitoring Your Cable Modem and Connected Network



Note: You may notice that some of the SB6183 Web Manager configuration settings may be blocked and cannot be modified. This may be due to some restrictions set up by your service provider to prevent unauthorized modifications to certain cable modem configuration parameters. Contact your service provider regarding special authorization to change the cable modem frequencies or other configuration settings.

View the SB6183 Network Connection Status

The Status screen displays the current connection status of the SB6183 and the downstream and upstream bonded channel connections for receive and send data transmissions. [Help](#) is available to resolve any connection issues that resulted in a “failed” state during the cable modem startup.

To open the Status screen:

1. Open the SB6183 Web Manager (see [Start the SB6183 Web Manager](#)).
2. Click the **Status** menu button or link on the SB6183 Web Manager screen.

The Status screen displays (see Figure 8).

3. Press **F5** to refresh or update the information on the screen.

Startup Procedure									
Procedure			Status						Comment
Acquire Downstream Channel									Locked
Connectivity State			OK						Operational
Boot State			OK						Operational
Configuration File			OK						
Security			Enabled						BPI+
DOCSIS Network Access Enabled			Allowed						
Downstream Bonded Channels									
Channel	Lock Status	Modulation	Channel ID	Frequency	Power	SNR	Corrected	Uncorrectables	
1	Locked	QAM256	1	507000000 Hz	-5.6 dBmV	38.8 dB	0	0	
Upstream Bonded Channels									
Channel	Lock Status	US Channel Type	Channel ID	Symbol Rate	Frequency	Power			
1	Locked	TDMA	1	1280 Ksym/sec	22864000 Hz	55.0 dBmV			
Current System Time: Wed Dec 09 16:55:18 2015									

Figure 8: SB6183 Status Screen

View the SB6183 Product Information

The SB6183 Product Information screen displays the hardware and firmware versions, MAC address, serial number and operation status for the SB6183.

To open the Addresses screen:

1. Open the SB6183 Web Manager (see [Start the SB6183 Web Manager](#)).
2. Click the **Product Information** menu button or link on the SB6183 Web Manager screen.

Information	
Standard Specification Compliant	DOCSIS 3.0
Hardware Version	1
Software Version	D30CM-OSPREY-1.5.0.1-GA-01-NOSH
Cable Modem MAC Address	e4:83:99:1d:27:d7
Serial Number	391601328700008602020968
Status	
Up Time	0 days 01h:37m:25s

Figure 9: SB6183 Product Information Screen

3. Press **F5** to refresh or update the information on the screen.

View the SB6183 Event Log

The SB6183 generates a running log of the time and events or activities that it detects during the cable modem operation.



Note: This information may be useful to help diagnose and correct any problems that may occur with your cable modem. You may want to provide this information if you have to contact ARRIS Technical Support or your service provider for assistance.

To open the Logs screen:

1. Open the SB6183 Web Manager (see [Start the SB6183 Web Manager](#)).
2. Click the **Event Logs** menu button or link on the SB6183 Web Manager screen.
3. Press **F5** to refresh or update the information on the screen.
4. Click **Clear Log** if you want to delete the log entries.

Time	Priority	Description
Time Not Established	Warning (5)	DHCP WARNING - Non-critical field invalid in response ;CM-MAC=e4:83:99:1d:27:d7;CMTS-MAC=00:04:28:25:9c:55;CM-QOS=1.0;CM-VER=3.0;
Time Not Established	Notice (6)	Honoring MDD; IP provisioning mode = IPv4
Time Not Established	Warning (5)	Lost MDD Timeout;CM-MAC=e4:83:99:1d:27:d7;CMTS-MAC=00:04:28:25:9c:55;CM-QOS=1.0;CM-VER=3.0;
Time Not Established	Critical (3)	No Ranging Response received - T3 time-out
Time Not Established	Critical (3)	Unicast Ranging Received Abort Response - Re-initializing MAC;CM-MAC=e4:83:99:1d:27:d7;CMTS-MAC=00:04:28:25:9c:54;CM-QOS=1.0;CM-VER=3.0;
Time Not Established	Critical (3)	No Ranging Response received - T3 time-out

Figure 10: SB6183 Event Logs Screen

View the SB6183 Cable Modem Configuration

The SB6183 Cable Modem Configuration screen displays the downstream and upstream connection to the network. When the SB6183 successfully connects to the network, it stores the connection frequency to automatically connect whenever you have to log back in to the SB6183.

To open the Configuration screen:

1. Open the SB6183 Web Manager (see [Start the SB6183 Web Manager](#)).
2. Click the **Configuration** menu tab or link on the SB6183 Web Manager screen.



Note: The configuration settings on the SB6183 Configuration screen are read-only and cannot be modified. You will have to contact your service provider to obtain special authorization to change the cable modem frequencies and other configuration settings.

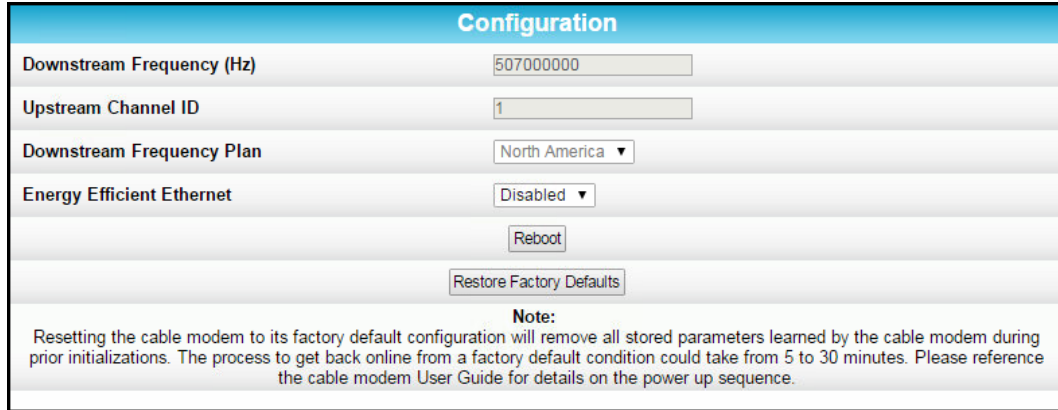

Figure 11: SB6183 Configuration Screen

Reset the SB6183 Configuration Settings

You can restore the SB6183 to the factory default settings using the Configuration screen. This process will delete the current settings and take approximately 5 to 30 minutes to complete. Your network connection will remain disabled until after the SB6183 configuration is restored.



WARNING! This action deletes the current SB6183 configuration and replaces it with the factory default settings.

To open the Configuration screen:

1. Open the SB6183 Web Manager (see [Start the SB6183 Web Manager](#)).
2. Click the **Configuration** menu tab or link on the SB6183 Web Manager Menu.

The Configuration screen displays.

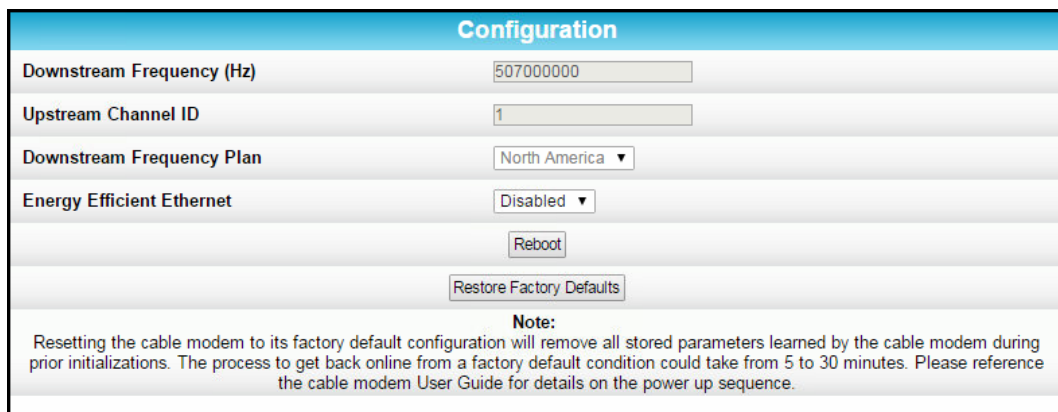

Figure 12: SB6183 Configuration Screen

3. Click **Restore Factory Defaults**.

The following message dialog will display.

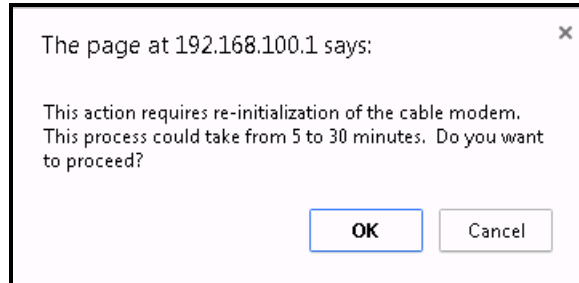

Figure 13: Restore Factory Defaults Dialog Box

4. Click **OK** to continue.

The SB6183 Web Manager will automatically open when the Reset All Defaults process is finished.

Restart the SB6183

To reboot the SB6183:

1. Open the SB6183 Web Manager (see [Start the SB6183 Web Manager](#)).
1. Click the **Configuration** menu tab or menu link on the SB6183 Web Manager Menu.

The Configuration screen displays.

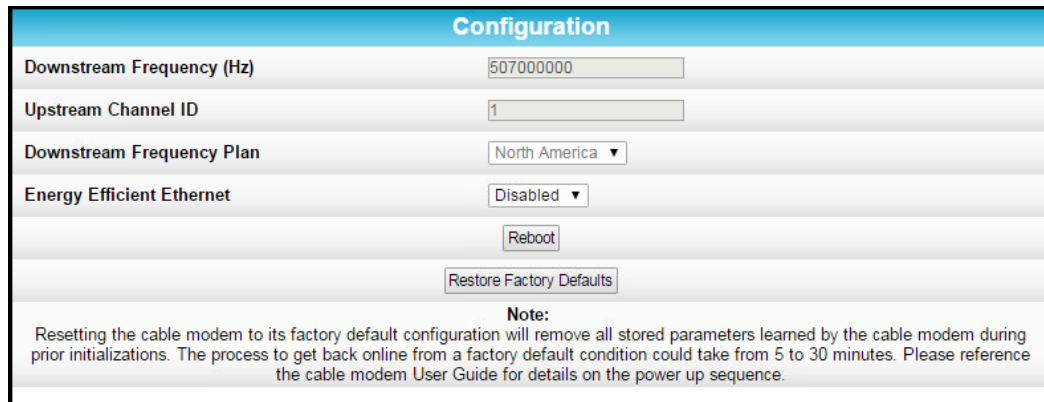

Figure 14: SB6183 Configuration Screen

2. Click **Reboot**.

The following message dialog will display:

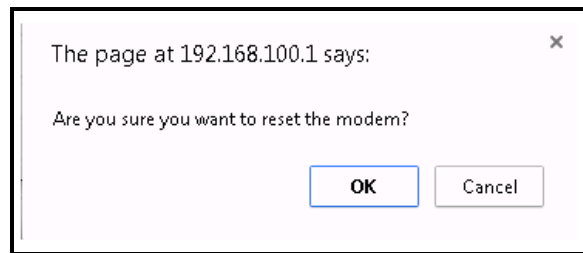

Figure 15: Cable Modem-Reboot Dialog Box

3. Click **OK**.
The following message will display: **The device has been reset... RELOAD.**
4. Click **RELOAD** to open the SB6183 Web Manager.

Exit the SB6183 Web Manager

To exit the SB6183 Web Manager:

- Click the **Close** button in the upper right corner of the web browser window

Troubleshooting Tips

If the solutions listed in the Troubleshooting Solutions table below do not solve your problem, please contact your service provider for assistance. Your service provider may ask for the status of the SB6183 front panel LEDs (see [Front Panel LED Icons and Error Conditions 27](#)) for more information).

You may have to reset the SB6183 configuration to the default factory settings if the SB6183 is not functioning properly. See [Reset the SB6183 Configuration Settings](#) for more information.

Solutions

Table 5. Troubleshooting Solutions





Modem Problem	Possible Solution
Power LED Icon is OFF	<ul style="list-style-type: none"> ■ Check the power connection from the cable modem to the electrical wall outlet. ■ Check that the electrical wall outlet is working. Is the outlet controlled by a wall light switch? If so, disconnect the cable modem power cord and connect it to another electrical wall outlet that is not controlled by a wall light switch.
Cannot Send or Receive Data	<ul style="list-style-type: none"> ■ Check each end of the coaxial cable connection on the cable modem and cable wall outlet. Use your hand to tighten each connector, if necessary. ■ Check the Ethernet cable to make sure it is properly connected to the cable modem and computer. ■ On the front panel, check the status of the LED icons and refer to Front Panel LED Icons and Error Conditions (page 27) to identify the problem. ■ If you have cable television service, check your television to ensure your cable service is operating properly. ■ If none of the above solutions resolves the problem, contact your service provider or call ARRIS Technical Support at 1-877-466-8646 for assistance.

Modem Problem	Possible Solution
Cannot Access the Internet	<ul style="list-style-type: none"> ■ Check that all cable and power connections on your cable modem and computer are properly connected. ■ Check that the Power and Online LED icons on the front panel are lit up solid. ■ Contact your service provider for assistance.

Front Panel LED Icons and Error Conditions

The SB6183 front panel LED icons provide status information for the following error conditions:

Table 6. Front Panel LED Icons and Error Conditions

Led Icon	Status	If, During Startup:	If, During Normal Operation
 POWER	OFF	SB6183 is not properly plugged into the electrical outlet	SB6183 is unplugged
 RECEIVE	FLASHING	Downstream receive channel cannot be acquired	Downstream channel is lost
 SEND	FLASHING	Upstream send channel cannot be acquired	Upstream channel is lost
 ONLINE	FLASHING	IP registration is unsuccessful	IP registration is lost

Warranty Information

SURFboard SB6183 DOCSIS 3.0 Cable Modem

ARRIS Enterprises, Inc. ("ARRIS")

Retail Purchasers: If you purchased this Product directly from ARRIS or from an authorized ARRIS retail reseller, ARRIS warrants to you, the original end user customer, that (A) the Product, excluding Software, will be free from defects in materials and workmanship under normal use, and (B) with respect to Software, (i) the media on which the Software is provided will be free from defects in material and workmanship under normal use, and (ii) the Software will perform substantially as described in its documentation. This Limited Warranty to you, the original end user customer, continues (A) for Software and the media upon which it is provided, for a period of ninety (90) days from the date of purchase from ARRIS or an authorized ARRIS reseller, and (B) for the Product (excluding Software), for a period of two (2) years from the date of purchase from ARRIS or from an authorized ARRIS reseller. To take advantage of this Limited Warranty or to obtain technical support, you must call the ARRIS toll-free phone number **1-877-466-8646**. Technical support charges may apply. ARRIS' sole and exclusive obligation under this Limited Warranty for retail sales shall be to repair or replace any Product or Software that does not meet this Limited Warranty. All warranty claims must be made within the applicable Warranty Period.

Cable Operator or Service Provider Arrangements. If you did not purchase this Product directly from ARRIS or from a ARRIS authorized retail reseller, ARRIS does not warrant this Product to you, the end-user. A limited warranty for this Product (including Software) may have been provided to your cable operator or Internet Service Provider ("Service Provider") from whom you obtained the Product. Please contact your Service Provider if you experience problems with this Product.

General Information. The warranties described in this Section shall not apply: (i) to any Product subjected to accident, misuse, neglect, alteration, Acts of God, improper handling, improper transport, improper storage, improper use or application, improper installation, improper testing or unauthorized repair; or (ii) to cosmetic problems or defects which result from normal wear and tear under ordinary use, and do not affect the performance or use of the Product. ARRIS' warranties apply only to a Product that is manufactured by ARRIS and identified by ARRIS owned trademark, trade name or product identification logos affixed to the Product. ARRIS does not warrant to you, the end user, or to anyone else that the Software will perform error free or without bugs.

ARRIS IS NOT RESPONSIBLE FOR, AND PROVIDES "AS IS" ANY SOFTWARE SUPPLIED BY 3RD PARTIES. EXCEPT AS EXPRESSLY STATED IN THIS SECTION ("WARRANTY INFORMATION"), THERE ARE NO WARRANTIES OF ANY KIND RELATING TO THE PRODUCT, EXPRESS, IMPLIED OR STATUTORY, INCLUDING BUT NOT LIMITED TO IMPLIED WARRANTIES OF MERCHANTABILITY, FITNESS FOR A PARTICULAR PURPOSE, OR THE WARRANTY AGAINST INFRINGEMENT PROVIDED IN THE UNIFORM COMMERCIAL CODE. Some states do not allow for the exclusion of implied warranties, so the above exclusion may not apply to you.

What additional provisions should I be aware of? Because it is impossible for ARRIS to know the purposes for which you acquired this Product or the uses to which you will put this Product, you assume full responsibility for the selection of the Product for its installation and use. While every reasonable effort has been made to insure that you will receive a Product that you can use and enjoy, ARRIS does not warrant that the functions of the Product will meet your requirements or that the operation of the Product will be uninterrupted or error-free.

ARRIS IS NOT RESPONSIBLE FOR PROBLEMS OR DAMAGE CAUSED BY THE INTERACTION OF THE PRODUCT WITH ANY OTHER SOFTWARE OR HARDWARE. ALL WARRANTIES ARE VOID IF THE PRODUCT IS OPENED, ALTERED, AND/OR DAMAGED.

THESE ARE YOUR SOLE AND EXCLUSIVE REMEDIES for any and all claims that you may have arising out of or in connection with this Product, whether made or suffered by you or another person and whether based in contract or tort.

IN NO EVENT SHALL ARRIS BE LIABLE TO YOU OR ANY OTHER PARTY FOR ANY DIRECT, INDIRECT, GENERAL, SPECIAL, INCIDENTAL, CONSEQUENTIAL, EXEMPLARY OR OTHER DAMAGES ARISING OUT OF THE USE OR INABILITY TO USE THE PRODUCT (INCLUDING, WITHOUT LIMITATION, DAMAGES FOR LOSS OF BUSINESS PROFITS, BUSINESS INTERRUPTION, LOSS OF INFORMATION OR ANY OTHER PECUNIARY LOSS), OR FROM ANY BREACH OF WARRANTY, EVEN IF ARRIS HAS BEEN ADVISED OF THE POSSIBILITY OF SUCH DAMAGES. IN NO CASE SHALL ARRIS' LIABILITY EXCEED THE AMOUNT YOU PAID FOR THE PRODUCT.

These matters are governed by the laws of the Commonwealth of Pennsylvania, without regard to conflict of laws principles and excluding the provisions of the United Nations Convention on Contracts for the International Sale of Goods.

Retail Purchasers Only. If you purchased this Product directly from ARRIS or from an ARRIS authorized retail reseller, please call the ARRIS toll-free number, **1-877-466-8646** for warranty service or technical support. Technical support charges may apply.

Cable Operator or Service Provider Arrangements. If you did not purchase this Product directly from ARRIS or from an ARRIS authorized retail reseller, please contact your Service Provider for technical support.

Corporate Headquarters

ARRIS · Suwanee · Georgia · 30024 · USA

T: 1-678-473-2000 F: 1-678-473-8470

www.arris.com

PN: 365-095-24153 x.2

December 2015