

STEP 3

In order to prevent product tip over, please follow the instruction below to secure the unit to the wall.

Hardware List			Qty
			1SET

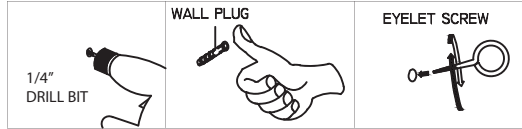

*NOTE: For one set

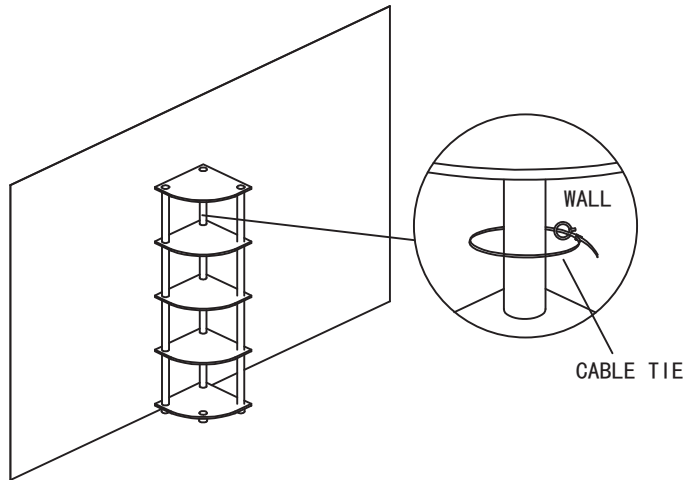

Recommended Maximum Weight

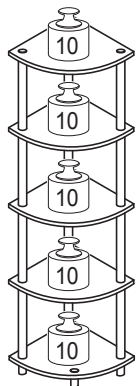

*Unit in Pound(lbs)

WARNING:

>This unit has been designed to support the maximum loads shown. Exceeding these load limits could cause sagging, instability, product collapse, and/or serious injury.

>DO NOT allow children to climb on unit.

>Put heavier items on lower shelves.



Assembly Instruction

Furinno Turn-N-Tube 5 Tier Corner Display Rack Multipurpose Shelving Unit

MODEL : 99811 (2 in 1)

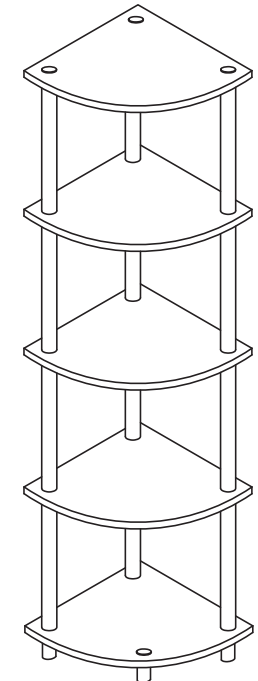
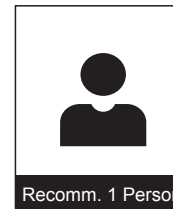



Customer Support

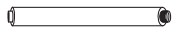

NEED HELP? For replacement requests or product inquiries, please contact our Customer Service Team by emailing us at support@furinno.com. Thank you for selecting Furinno!

www.furinno.com



No	Hardware List	Qty
1	Long Pole 	24pcs
2	Top Cap 	8pcs
3	Round Leg 	8pcs

*All the hardware quantity are for two sets.

No	Parts List	Qty
A	Top/Shelf Panel 	8pcs
B	Bottom Panel 	2pcs

Hardware List			Qty
			2SETS

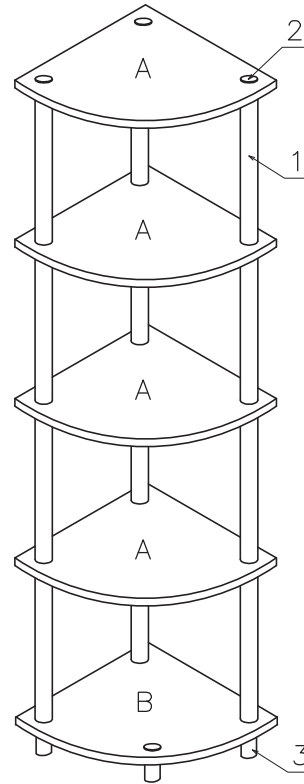
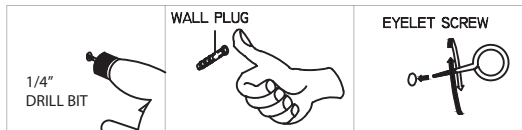

USEFUL HINTS BEFORE YOU START:

1. Read each step carefully before starting.
2. It is important that each step is performed in correct order to avoid difficulties.
3. Identify, sort and count the parts before assembly.
4. Assemble your furniture on packaging cardboard to prevent scratch or damage.
5. Clean the product with mild cleanser using soft damped cloth. Do not use harsh or abrasive cleanser.
6. Using incompatible hardware might cause damage to product.

STEP 1

1.1 Attach Long Pole (1), Top Cap (2) and Round Leg (3) to Bottom Panel (B).

1.2 Attach Shelf Panel (A) and tighten Long Pole (1), as shown:

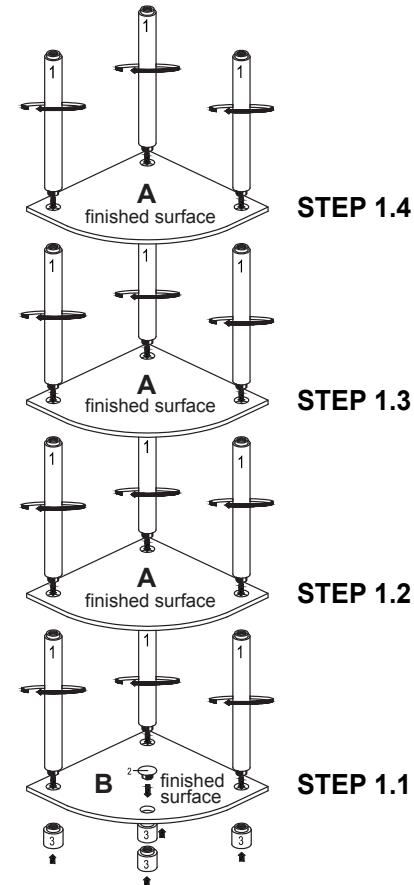

 ① Long Pole - 12pcs

 ② Top Cap - 1pc

 ③ Round Leg - 4pcs

*NOTE: For one set

STEP 2

Attach Top Panel (A) and tighten Top Cap (2), as shown:

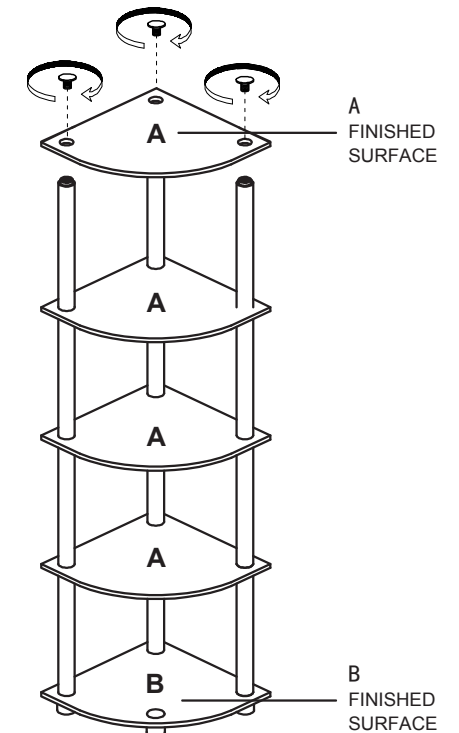

 ② Top Cap - 3pcs

*NOTE: For one set