

**Foreword**

This Instruction Manual is the standard version for all models for the packaged terminal air conditioners manufactured by our company. The appearance of the model that you purchased may be slightly different from the ones described in the Manual, but it does not affect the proper operations and usage. Please read this Manual carefully and keep the Manual available for reference at a later time.

**Addition to the user manual:**

- The packaged terminal air conditioner is not intended for the use of young children or infirm persons without supervision.
- The packaged terminal air conditioner shall be installed in accordance with national wiring regulations.
- If the power cord is damaged, it must be replaced by qualified persons in order to avoid a hazard.
- Due to continual product improvement, the right is reserved to change specifications and design without notice.



**WARNING**

This symbol refers to a hazard or unsafe practice which can result in severe personal injury or death.



**CAUTION**

This symbol refers to a hazard or unsafe practice which can result in severe personal injury or product or property damage.

**Contents**

---

Instructions to end-users	1
Names and functions of various parts	3
Use of unit mounted operation panel	4
Use of wall mounted controller	5
Use of hand held remote controller	6
Methods of maintenance	8
Diagnosis on troubleshooting	9
Installation procedures	10
Wall sleeve installation	12

# INSTRUCTIONS TO END-USERS

Read this Manual carefully before using the packaged terminal air conditioner to ensure proper operation of the unit.

## INSTRUCTIONS TO INSTALLATION

- Make sure that an authorized technician or contractor does the installation for you.



Make sure that breaker is installed for safe operations.

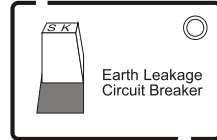

If breaker is not installed, it may result in electric shock or other hazards.

Do not install the unit in a place where there might be leakage of inflammable gases.

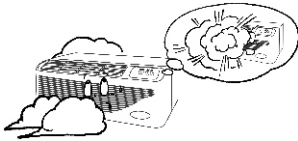

In the case that the gases are leaked out and accumulated around the machine, it may result in fire hazards or other accidents.

Make sure that the power source of the unit is properly grounded.

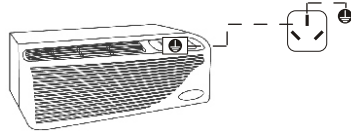

The grounding wire of the packaged terminal air conditioner must be firmly connected to the grounding wire of the power source. Improper grounding will lead to possible electric shock or other hazards.

## INSTRUCTIONS TO OPERATIONS



Do not press, stretch, damage, heat or modify the power cord.

It may result in electric shock, overheating, fire hazard or other accidents. In the case that the power cord is damaged or that a replacement for the power cord is required due to some other reasons, please contact our company dealer or an authorized maintenance technician.



Do not use the fuse with improper capacity or other metal wires.

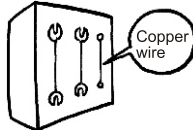

Improper use of metal wires, copper wires for the fuse may result in faulty performances of the machine or fire hazards.

Do not insert sticks or other hard obstructions into the air inlet or outlet.



The high-speed rotation of the fan blades may cause accidents.

Do not place such articles as insecticides, paints or other flammable spraying agents near the packaged terminal air conditioner or spray them against the air conditioner.

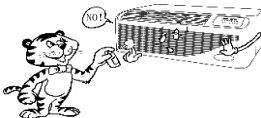

It might result in fire hazards.

If the air conditioner and the burning appliances have to be used in the same room, try to get good ventilation in the room.



Insufficient ventilation may lead to the hazard of anoxia.







Do not wash the air conditioner with water.

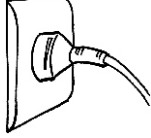
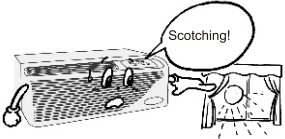

It may cause electric shock or other accidents.

# INSTRUCTIONS TO END-USERS

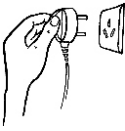

<p>Do not try to stop the operation of the package terminal air conditioner by pulling the power cable from the socket.</p>  <p>This could result in electric shock, fire hazard or other accidents.</p>	<p>Make sure that there is no dust on the plug before you plug in the power socket and make sure the plug is put correctly plugged into the socket.</p>  <p>If there is dust on the plug or the plug is not properly done, this could result in electric shock, fire hazards or other accidents.</p>	<p>Try as much as possible to avoid the sunlight and warm air from entering the room.</p>  <p>During the cooling operation, window curtains or louver blinds are to be used to shade off the sunlight.</p>
<p>Try to reduce the generation of heat in the room during cooling operations. Place the heating source outside of the room, if possible, do not use burning appliances in the air-conditioned room.</p>  <p>It may lead to the incomplete burning of these appliances.</p>	<p>Do not use the following articles:</p>  <p>Warm water (above 40°C or 104°F) Warm water might cause deformation or fading of colors of the packaged terminal air conditioner. Gasoline, paint diluting agent, benzene and abrasives, etc. may cause deformation or scratches to the packaged terminal air conditioner.</p>	<p>Do not let the delivered air blow to your body directly for long time.</p>  <p>It might cause discomfort of your body or harm your health.</p>
<p>Do not sit on the unit or place heavy objects on it.</p>  <p>The falling of the unit might cause body injuries or other accidents.</p>	<p>Check to see if the supporting parts of the units are properly fixed and firm.</p>  <p>If the supporting parts are damaged, repair them at once so as to prevent the unit from falling down which might cause body injuries or hurts.</p>	<p>If the air conditioner is not to be used for a long period of time, please pull out the plug from the power source socket to ensure safety. Turn off the air conditioner before pulling out the plug.</p> 



## INSTRUCTIONS FOR REMOVAL AND REPAIRS

- If the unit needs to be removed for installation elsewhere or for repairs, please contact our company dealer or authorized technicians.
- In case of occurrence of abnormality (burning smell, for example), please stop the operation of the unit, disconnect the power and contact our company dealer or authorized technicians.



# NAMES AND FUNCTIONS OF VARIOUS PARTS

## Front View

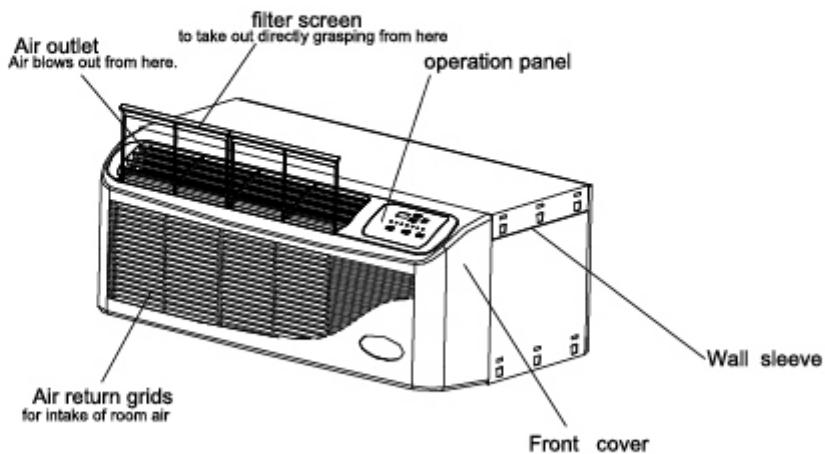

## Rear View

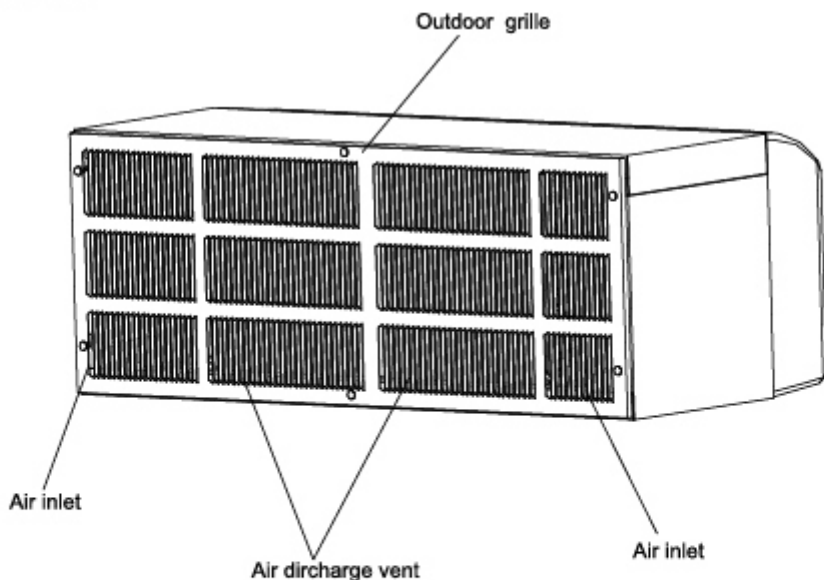

Features and appearance will vary.all the figures provide a demonstration to introduce the funtion.

# USE OF UNIT MOUNTED OPERATION PANEL

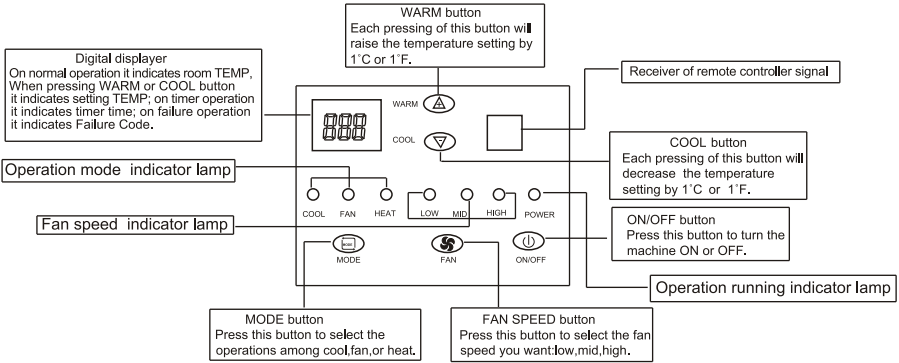

## Fresh air exchange procedure

1. Remove the front cover by pulling out at the bottom to release it, then lift it up to clear the rail along the chassis top (Fig a).
2. Put the air exchange switch to open state (Fig b).

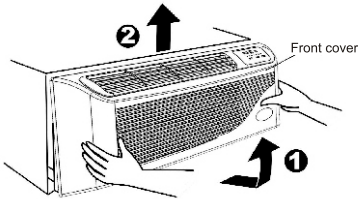

Fig a

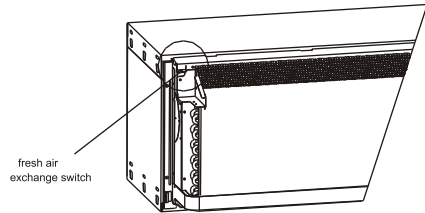

Fig b

### Note:

The air exchange switch is normally placed at the left closed position. When it is moved to the right, the unit will discharge a little amount of filthy air inside the room to keep the air fresh, but if the switch is placed at the right position for long time, the cooling effect will be affected.

### Self Diagnosis Functions

Our company has provided the thoughtful services for customers, and the air conditioner has been installed self diagnosis system to display the code for failure.

Failure Code	Content of defect
E1	Communication failure
E2	Indoor coil temperature sensor failure
E3	Indoor temperature sensor failure
E4	System abnormality protection
E5	Outdoor coil temperature sensor failure
E8	Overheating protection/Defrosting
DF	Defrosting



# USE OF WALL MOUNTED CONTROLLER

Wall mounted controller and hand held remote controller are optional parts, please read the sections corresponding to the specific model you have chosen.

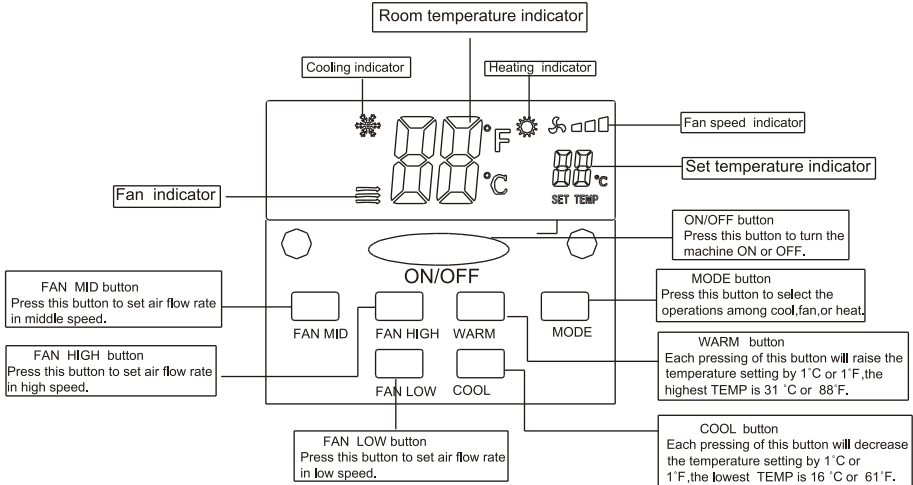

Note:

1. Do not use nails or other sharp objects to press the button, because the sharp objects will scratch the panel.
2. Pressing the WARM and COOL buttons together beyond 3 seconds can lock the panel keyboard, and pressing the two buttons again would cancel the lock function.
3. When you turn on the machine, if the wall mounted controller is connected, there will be 4 seconds delay for operating the controller. In this time the unit mounted operation panel and hand held remote controller can not work, but the digital pipe and indication lamp of operation panel can work. If the wall mounted controller is disconnected, there will be 3.5 seconds delay for operating the unit mounted operation panel and you will be able to operate the machine with hand held remote controller.

## Function of random time delay start-up

If it is in the situation of starting up before power cutting, then, it will start up automatically after the power is on, LED will display it immediately following the memorial content, and the relay will do time delay start-up according to the random numbers (120-240 seconds), which can prevent from the accident of electric network surge when the same type air-conditioners installed in the same groshop start up in the same time after power supply is initialized.



# USE OF HAND HELD REMOTE CONTROLLER

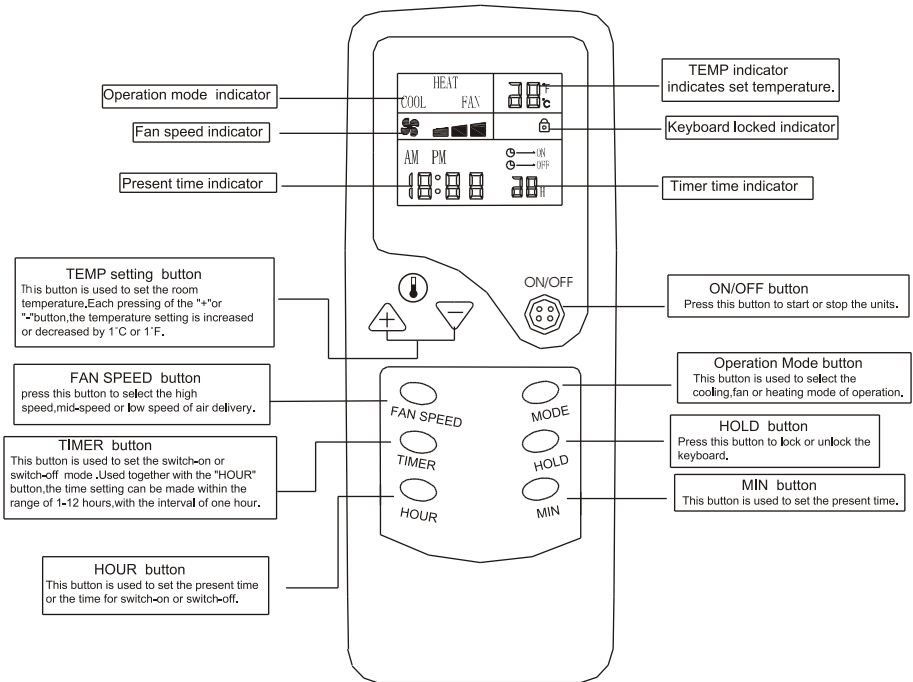

Above figure shows all indications for the purpose of explanation, practically only the applicable is indicated.

## Cool/Fan/Heat mode operation procedure

- Press the ON/OFF button with the remote controller pointing toward the packaged terminal air conditioner.
- Press the MODE button, select the operation mode: cool/fan/heat.
- Press + or - button, to set your desired temperature. The setting temperature range is 61-88°F (16-31°C).
- Press the FAN SPEED button, to set your desired air flow rate: high/mid/ low.



# USE OF HAND HELD REMOTE CONTROLLER

## Present time setting procedure

When cells are inserted,the present time is automatically set to AM 0:00.EX.:set to AM10:30.

- Open the back cover,push the CLK button .The time indicator is flickering and can set the present time.
- Press the HOUR button.(set to AM 10:00)
- Press the MIN button.(set to 30)
- Press the CLK button again,and then close the back cover.

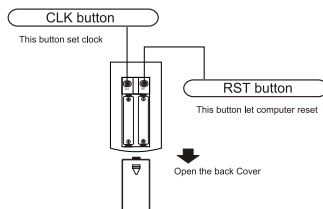

## Timer operation procedure

### Timed switch-off

- During the operation ,press the TIMER button and the unit will enter the timed switch-off mode.
- Press the HOUR button to set the desired time,the timer can make the setting in the range from 1-12 hours

After the setting,the digits shown on the display screen will go down by 1 for every elapsed hour.

### Timed switch-on

- In the standby mode,press the TIMER button and the unit will enter the timed switch-on mode.
- Pres the HOUR button to set the desired time,the timer can make the setting in the range from 1-12 hours.

After the setting,the digits shown on the display screen will go down by 1 for every elapsed hour.

## Releasing procedure

Press the TIMER button again to release the mode.

## Replacement of batteries

When the signal from the remote controller becomes weak and the unit can not receive it properly,or the indication on the display screen becomes blurred,please replace the hand held remote controller with two new batteries.

### Note:

- 1、 The positive and negative poles must match the installation positions
- 2、 Do not use an old battery together with a new battery.
- 3、 If the hand held remote controller is not to be used for long time,take out the batteries so as to prevent the leakage of the electrolyte from damaging the hand held remote controller.





# METHODS OF MAINTENANCE

Before proceeding with the methods of maintenance, make sure that the packaged terminal air conditioner is turned off and the plug is pulled out from the socket.

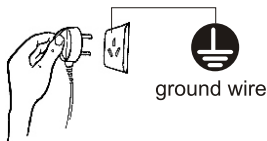

## Before the operational seasons

- 1 Check to see if there are any blocking objects around the air inlet and outlet of the units.
- 2 Check to see if the installation base is corroded or rusty.
- 3 Check if the grounding is properly made.



- 4 Check if the air filter screen is clean.
- 5 Connect to the power source
- 6 Load batteries in the remote controller. (remote controller model)

## After the operational seasons

- 1 Set the temperature at 30°C or 86°F and let the machine run in cooling mode for half a day. Make the interior of the unit dry. 
- 2 Stop the operation of the machine and turn off the power switch. 

It is recommended to pull the plug from the power socket in the non-operational season for the sake of safety and saving energy.
- 3 Clean the air filter screen and install it back to place.
- 4 Clean the air conditioner. 
- 5 Take the batteries out from the remote controller (remote controller model).

## During the operational seasons

Clean the air filter screen (at a standard interval of once every two weeks).

- 1 Remove the air filter screen

Take out the air filter screen directly grasping it from the front cover

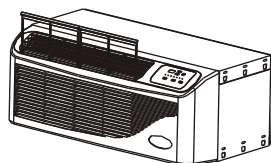

- 2 Clean the air filter screen

If the air filter screen is very dirty, you may use lukewarm water (about 30°C or 86°F) to clean it, and then air it dry.

### Note:

- Do not use boiling water to clean the screen.
- Do not bake the screen dry.
- Do not pull it with too much force.

- 3 Install the air filter screen.

If the air conditioner is operated without an air filter screen, the interior of the unit will be contaminated by dirt which might cause performance failure or even damage of parts.

- 4 Clean the air conditioner

- Use soft dry cloth to wipe the air conditioner or use a vacuum cleaner to do the cleaning.
- If the air conditioner is very dirty, you may use a piece of cloth soaked with household neutral detergent to do the cleaning.

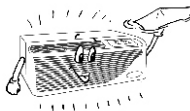

### Note:

If the air filter screen is blocked by dust, the performance of cooling and heating operations will be affected, the operational noise will be larger and the power consumption will be increased. Therefore, periodic cleaning of the air filter screen is necessary.

# DIAGNOSIS ON TROUBLESHOOTING

## Inspection and treatment prior to maintenance

Please check the following items before asking our company dealer or authorized technician for after-sale services:

### The packaged terminal air conditioner does not work at all.

Is the power plug inserted into the socket properly?

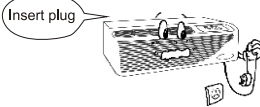

Is there a power failure or is the fuse blown?

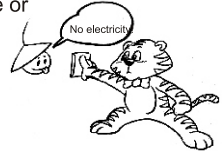

Is the timer set for the "TIMER-ON" mode?

If the packaged terminal air conditioner (remote controller model) is set for timed switch-on operation mode, it will not start operating before the set time is reached.

Is the ambient temperature lower than 16°C or 61°F ?

If so, the auto protection function of the air conditioner will prevent the unit from cooling operation.

### There is no sufficient cooling or heating.

Is the room temperature set properly?

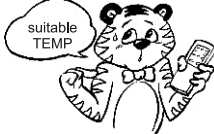

Is the air filter screen clean (not blocked)?

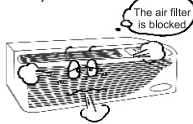

Are the doors or windows opened?

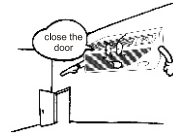

Is the room directly exposed to sunlight?



Are there any heating sources inside the room?

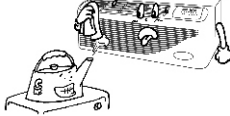

Are there many people inside the room?



If the packaged terminal air conditioner remains abnormal in operation after the above checks and inspection, please disconnect the power and contact with our company dealer or the authorized technicians.

In any of the following cases, please turn off the power of the packaged terminal air conditioner and immediately contact the dealer or a authorized technician.

The fuse is frequently blown or the breaker keeps shutting off.

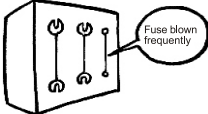

The electric wire turns abnormally hot.

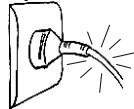

The insulation sheath of the power cord is torn.

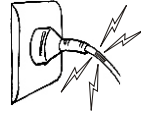

The switches do not work.

There are abnormal noises when the machine is operating.

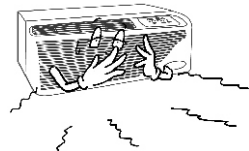

# INSTALLATION PROCEDURES



To ensure the unit operates safely and efficiently, it must be installed by qualified or experienced technicians.

- The appliance must be installed in accordance with national wiring regulations.
- If the supply cord is damaged, it must be replaced by the manufacturer service agent or a qualified technician in order to avoid a hazard.

## 1. NAMES OF PARTS

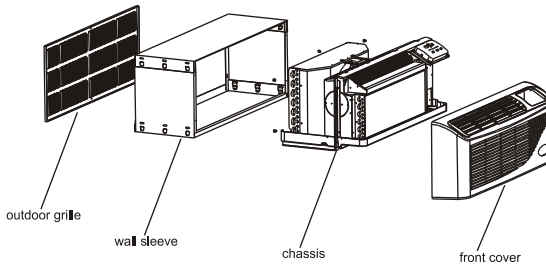

## 2. WALL SLEEVE AND OUTDOOR GRILLE

- 1) The wall sleeve must be properly installed according to the wall sleeve installation instructions (Page 12-15).
- 2) Install the outdoor grille from the room side. If replacing an old chassis with an existing grille or using a specialized grille in a new installation, please contact our company dealer to determine if the new chassis should be used with the nonstandard specialized grille.

## 3. INSTALLATION

### 1) Front cover removal

Remove the front cover by pulling out at the bottom to release it, then lift it up to clear the rail along the chassis top.

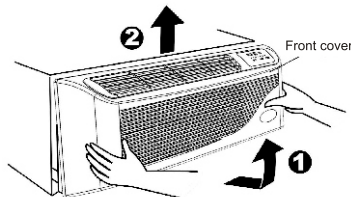

# INSTALLATION PROCEDURES

## 2) Chassis installation

Slide the chassis into the wall sleeve until the chassis flanges contact the front edge of the wall sleeve, then secure with four screws through the chassis flange holes.

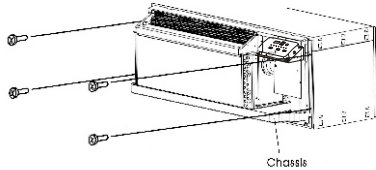
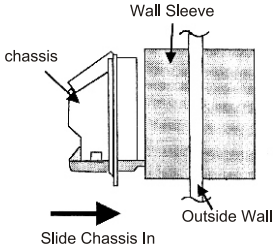

## 3) Wires connection of wall mounted controller (optional procedure, it is just suitable for wall mounted controller model)

Firmly connect the electrical junctor of wall mounted controller to the junctor on the right bottom of chassis.

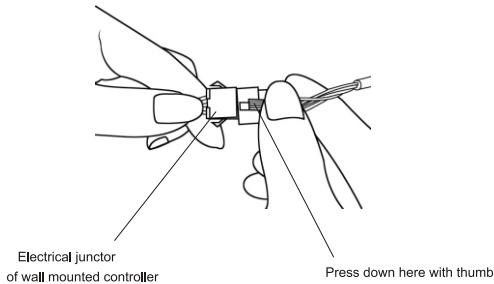

## 4) Front cover installation

Reinstall the front cover by hooking the top over the rail along the chassis top, then pushing it in at the bottom (Fig13).

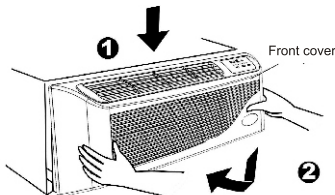

## 4. TEST OPERATION

Connect to power source, check to see if the operational mode buttons work properly.  
Check to see if the room temperature control and the function controls work properly.  
Check if the water drainage is smooth and unblocked.  
Check if there are abnormal sounds during operations.

